

Assembly Instructions

Caution: You must read this before you proceed

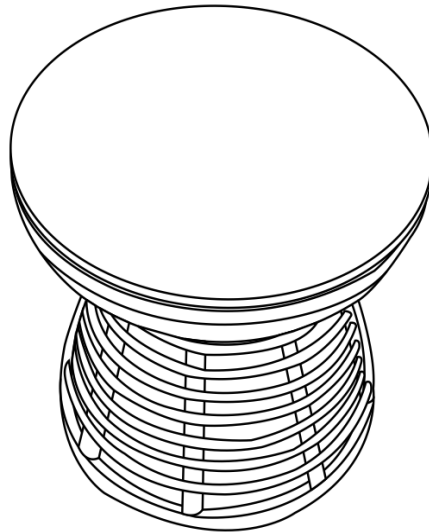

TABLE

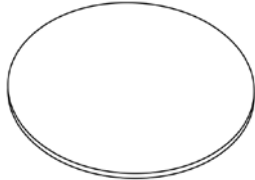
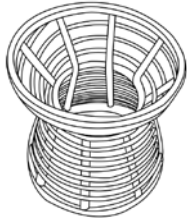

Part List

Label	Picture	Description	QTY
A		Tempered Glass	1
B		Frame	1

Hardware

Label	Picture	Description	QTY
①		Suction Cup (M6X20mm)	4
②		Leveler	5

Assembly Preparation

Before
Beginning
Assembly:

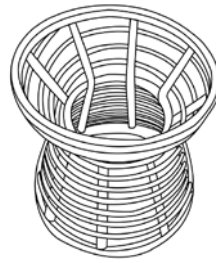
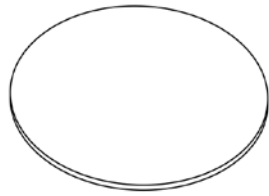

- Read instructions, cover to cover-



- Have 2 adults on hand for assembly-



- Do not assemble on flooring or carpet-



- Assemble on a clean non-marring surface (packing foam)-



- Save all packaging until finished-

Assembly Steps

Overview

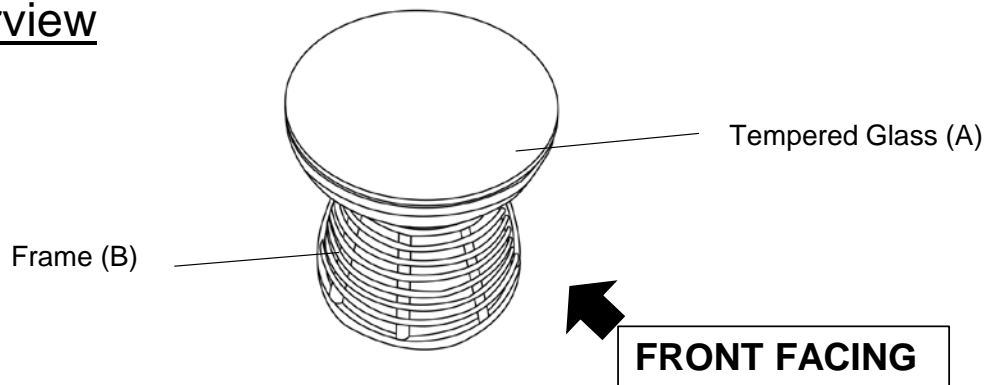

This Table has multiple parts and may require up to 30 minutes to assemble. To give you an overview of the Table, the above picture is to help you put the various parts into perspective. Please read through the instructions below to familiarise yourself with the parts and steps before assembly.

Step 1

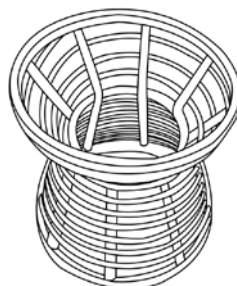
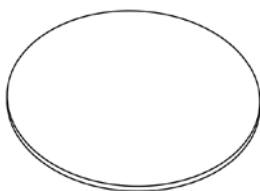

Unpack and place all parts on a clean, non-marring surface.

Step 2

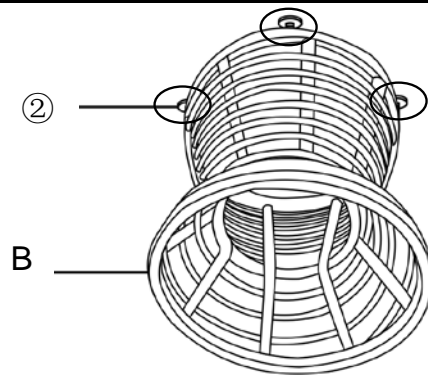

Turn over the Table.

Put the Levelers (②) on the bottom of the frame.

Adjust the Levelers until the Table is level with the ground.

Step 3

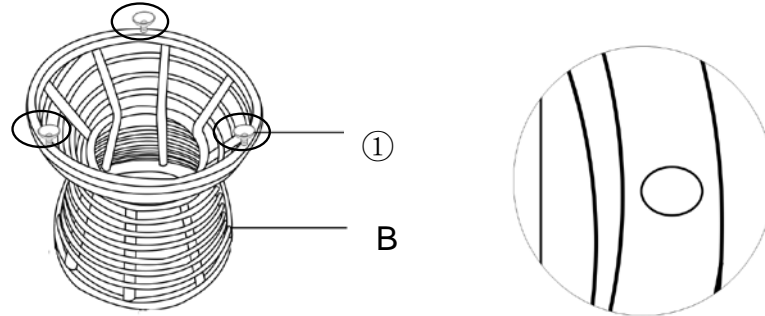

Insert the Suction Cups(①) into Table Frame(B) as pictured above.

Step 4

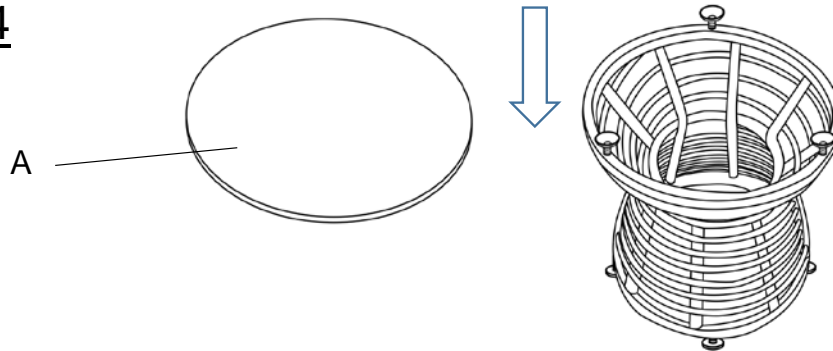



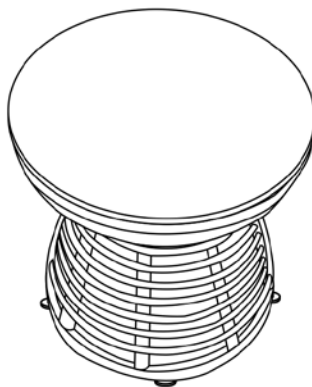

















Carefully place the Tempered Glass(A) on the Table.



Your Table is ready for use.

This Table can only be used on a flat and level surface.

Care & Maintenance

-   ● Do not put hot items directly on furniture surface
 -   ● Do not clean furniture with harsh cleansers or polish.
 -   ● To obtain the longest lifespan of your outdoor products, minimizing exposure to direct sunlight is recommended.
 -   ● Children should not climb or jump on the furniture.
 -   ● Do not write on furniture without a padded barrier to protect the surface.
 -   ● To obtain the longest lifespan of your outdoor products, avoid extended and lengthy exposure to rain, snow, and direct sunshine. Whenever possible cover the product and /or place under patio or awnings.
 -   ● Not for commercial use. For residential use only .
 -   ● Stains may be removed with mild soap solution and damp cloth.
 -   ● Keep away from sources of ignition.
-
-   ● Dust and pick-up spills using a clean, non-colored, lint-free cloth.