

# **INSTALLATION**

*Product Manual*

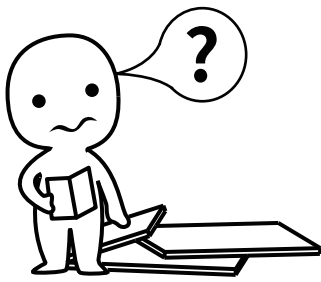

### **IMPORTANT INFORMATION!**

please read the entire manual before starting to assemble and/or using this product. follow the manual thoroughly and keep it for further reference.

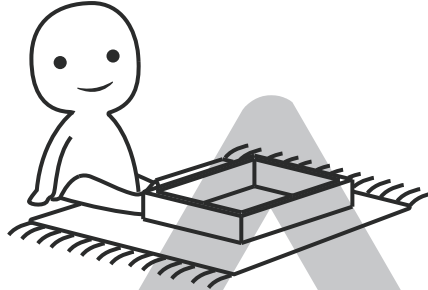
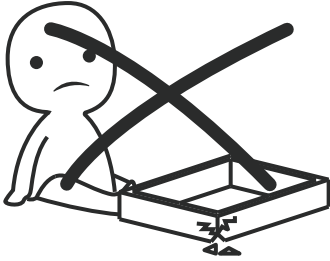

### **AVOID SCRATCHES!**

In order to avoid scratching this furniture should be assembled on a soft layer- could be a rug.

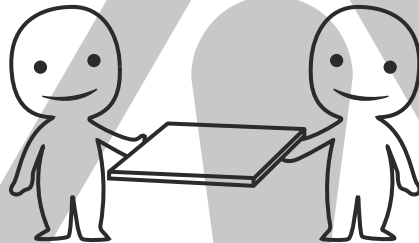

### **IMPROVE EFFICIENCY !**

Try to find a partner to install with you, which can speed up the installation efficiency and shorten the time.

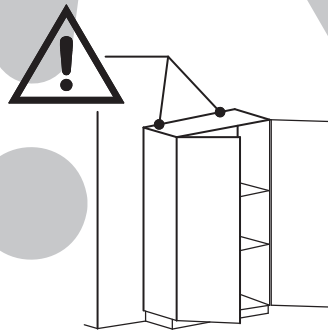
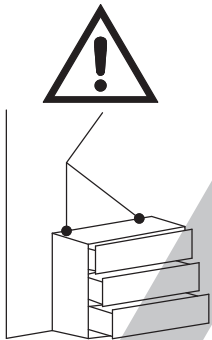

### **ANTI-TOPPLE WARNING !**

Overtured furniture can cause serious or fatal crush injuries. To prevent tipping over, be sure to use the wall attachment, if not included with this product. Please purchase the wall attachment that fit your wall. If unsure, seek professional advice. Please read and follow each step of the instructions carefully.

### **IMPORTANT !**

It is important that any product which is assembled using any kind of screw is re-tightened 2 weeks after assembly, and once every 3 months - in order to assure stability through-out the lifespan of the product.

For regular maintenance and cleaning of the product, for the frame, please use a rag dipped in neutral detergent to fully wipe it, and then dry it with a clean rag. For glass materials, wipe with a rag dampened with water glass cleaner, and then dry with a dry rag.

Do not use an electric screwdriver, and do not use too much force when installing, because the board is easy to break.



Please prepare the following tools

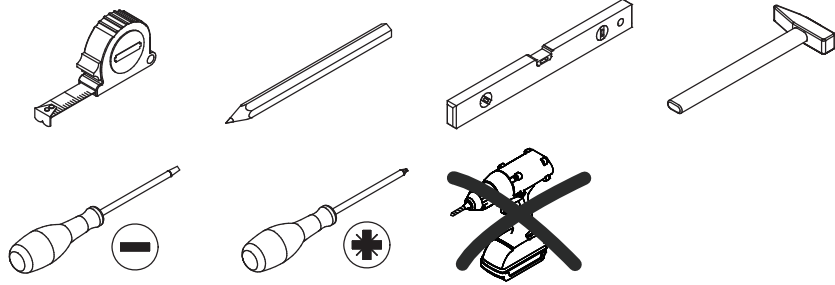

When installing, please carefully confirm whether each screw corresponds to the manual, accessories with similar shapes can be distinguished by size

A x 46

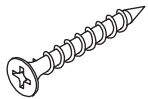

Ø 4 x 35 mm

B x 50

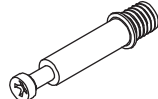

Ø 6 x 35 mm

C x 50



Ø 15 x 9 mm

D x 22

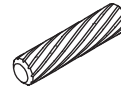

Ø 6 x 30 mm

E x 18



Ø 4 x 18 mm

F x 9



G x 72



Ø 3 x 12 mm

DL x 9

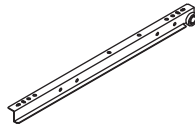

300 mm

DR x 9

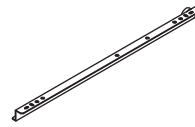

300 mm

CL x 9

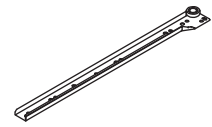

300 mm

CR x 9

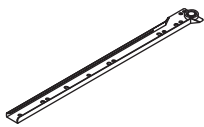

300 mm

H x 14



Ø 4 x 14 mm

I x 12



Ø 3 x 16 mm

J x 12



K x 2



Ø 6 x 30 mm

L x 8



Ø 6 x 20 mm

M x 1

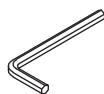

N x 2



P x 4



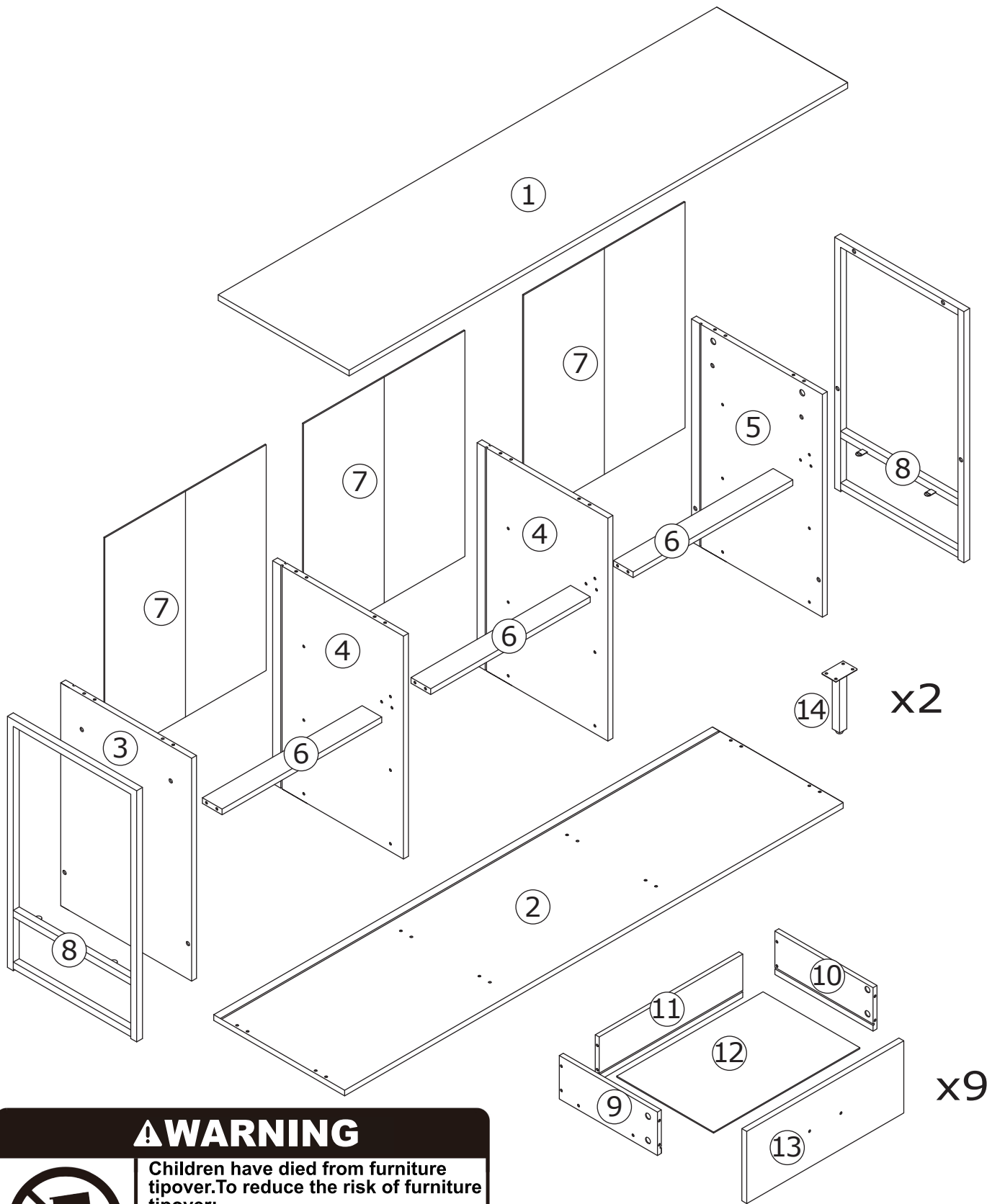

## ⚠ WARNING



**Children have died from furniture tipover. To reduce the risk of furniture tipover:**

- ALWAYS install Anti-tip device provided.
- NEVER put a TV on this product.
- NEVER allow children to stand, climb or hang on drawers, doors, or shelves.
- NEVER open more than one drawer at a time.
- Place heaviest items in the lowest drawers.

*This is a permanent label.  
Do not remove!*

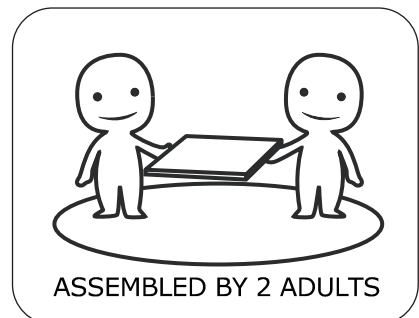

1

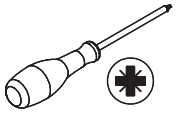
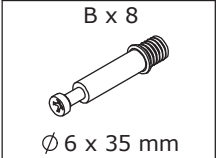

Screw eccentric rod(B) into board 1 with a screwdriver at first.

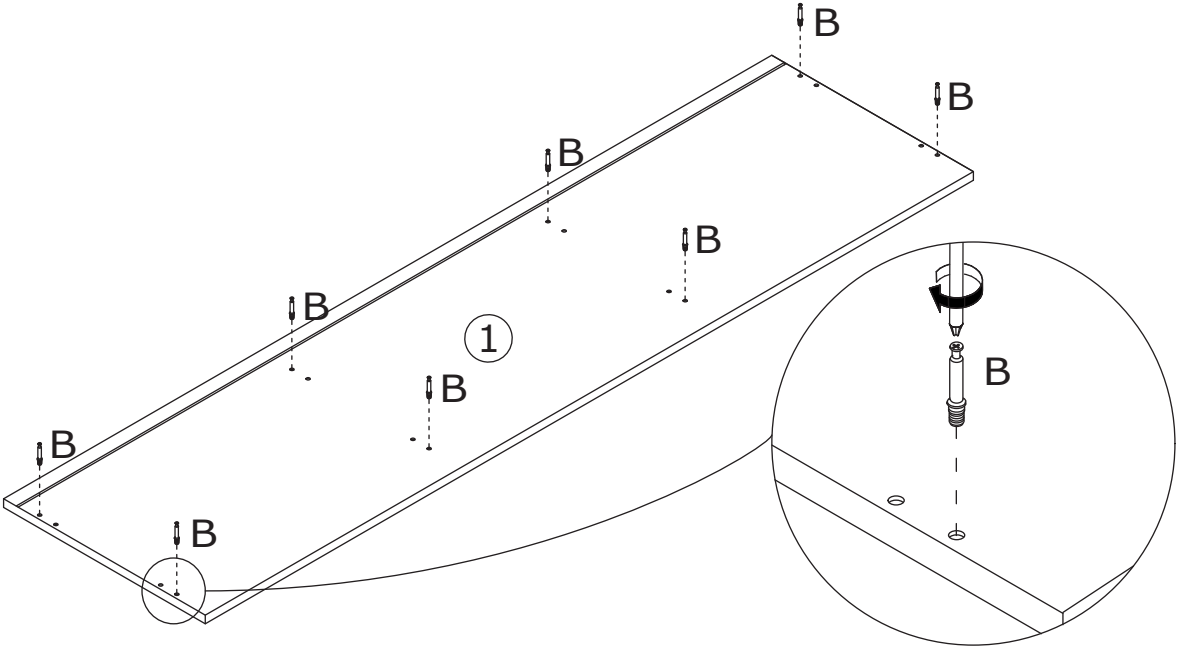
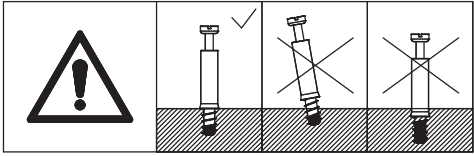

2

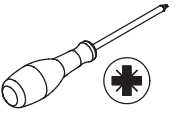
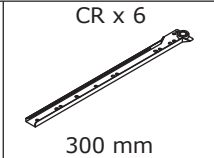
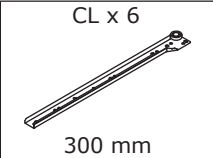
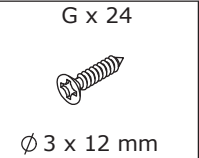
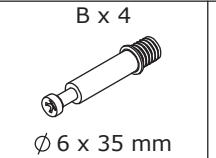

Fix slide rail(CL) to board 4 with screw(G) and screw eccentric rod(B) at first. Flip the board, fix slide rail(CR) and screw eccentric rod(B) into as well.

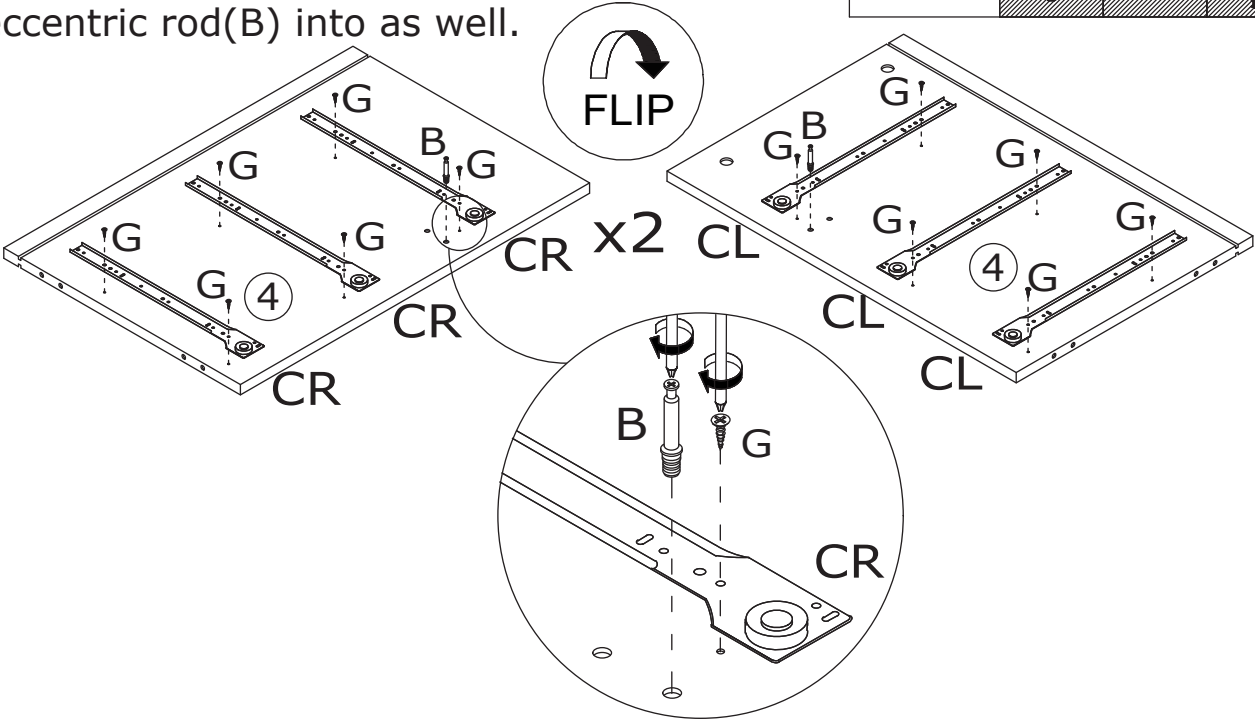
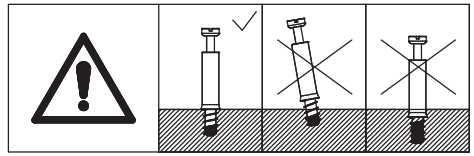

3

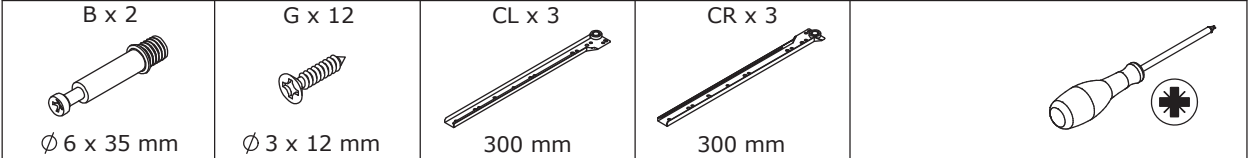

Fix slide rail(CL) and (CR) to board 3 and 5 respectively with screw(G) at first. Screw eccentric rod(B) into board 3 and 5 as shown.

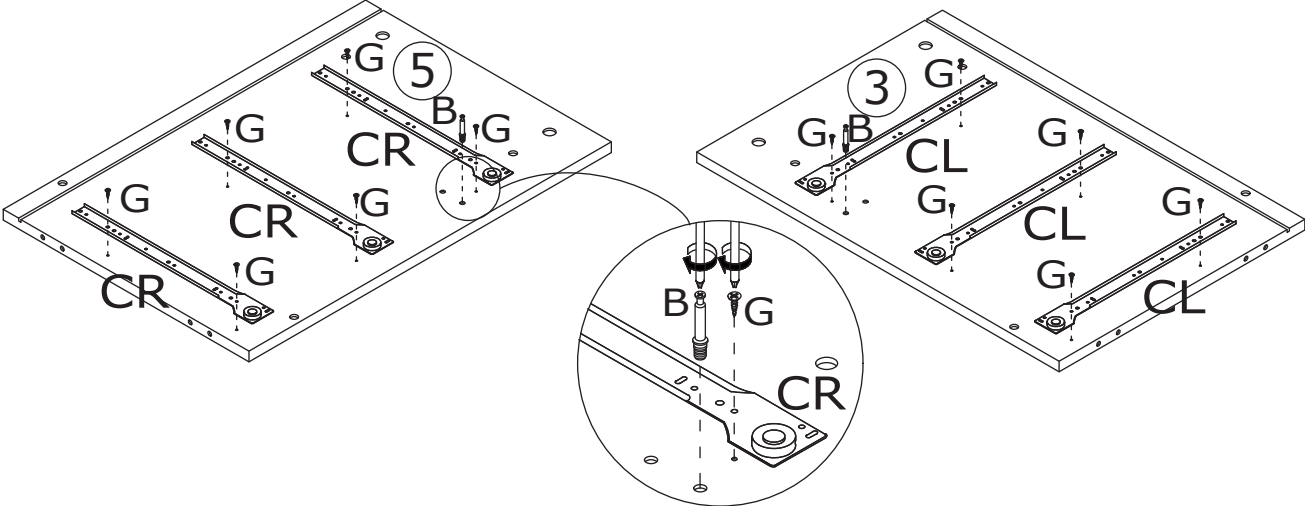
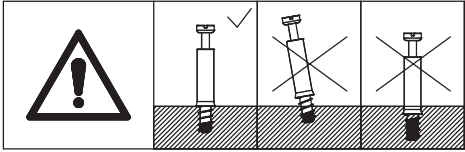

4



Connect board 6 to board 4 using wooden dowel(D), add cam lock(C) into board 6 and turn clockwise to tighten as shown.

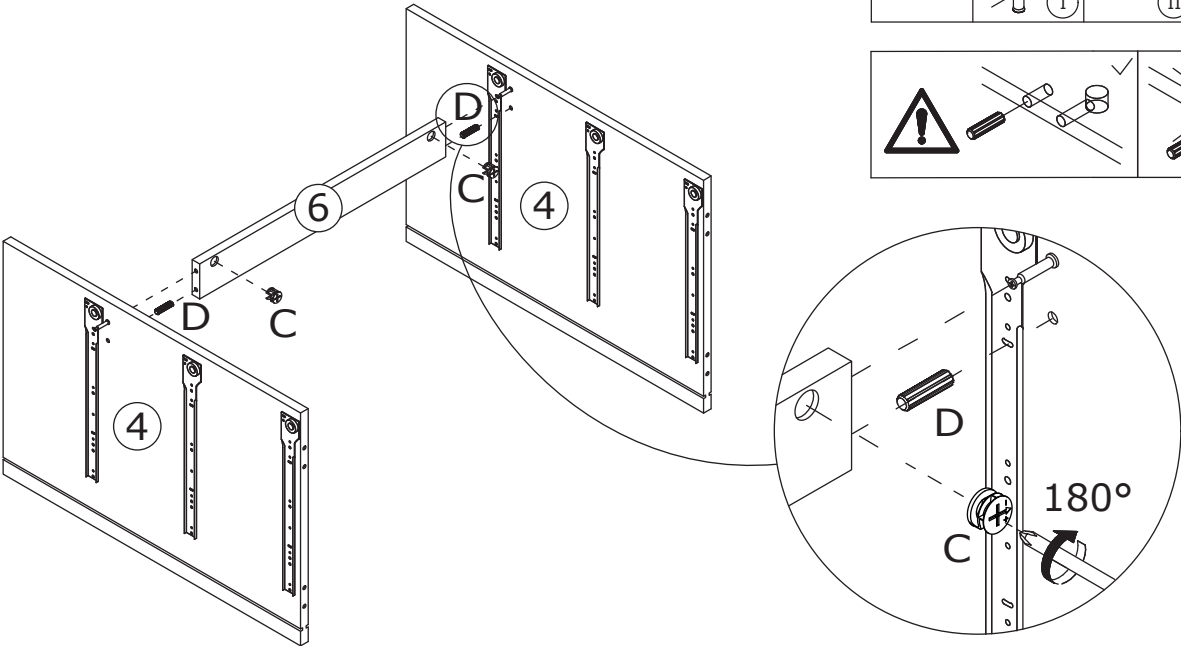
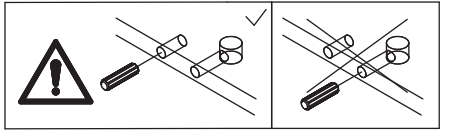
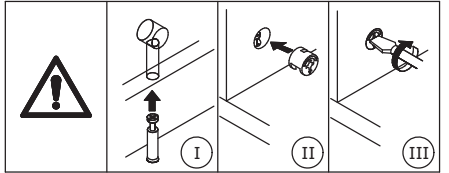

5

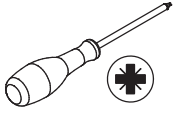
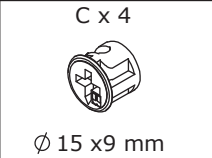
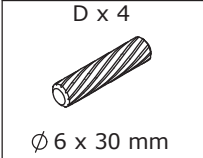

Connect board 6 to board 3 and 4 using wooden dowel(D), add cam lock(C) into board 6 and turn clockwise to tighten as shown.

Connect board 6 to board 5 and 4 using wooden dowel(D), add cam lock(C) into board 6 and turn clockwise to tighten as shown.

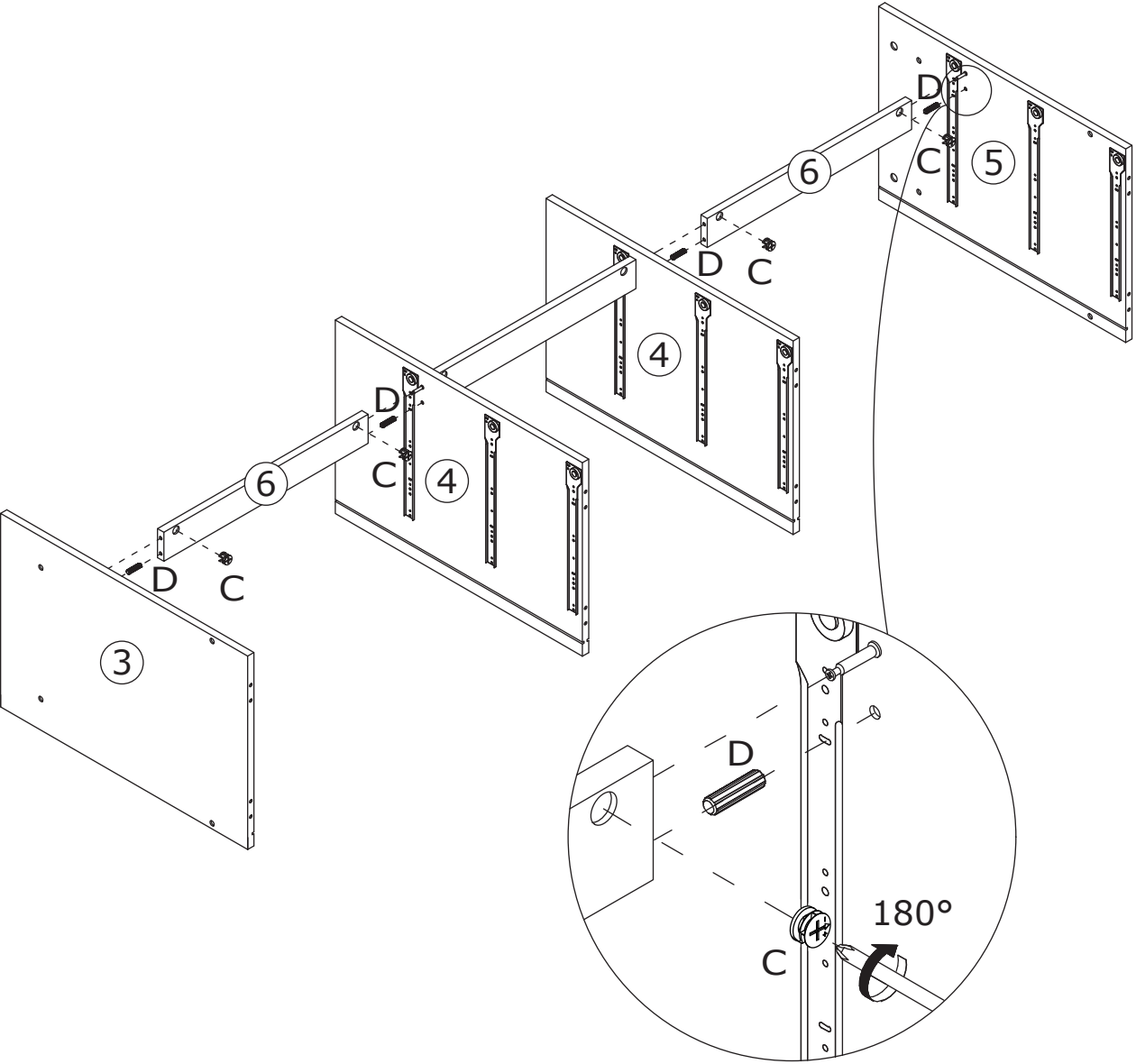
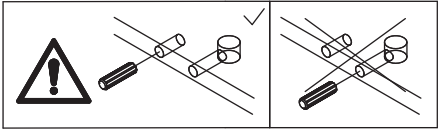
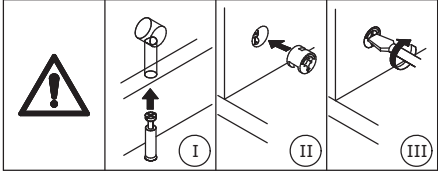

6

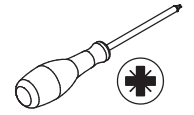
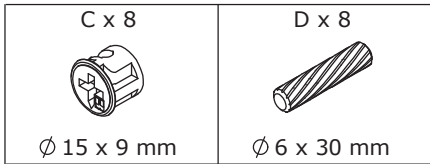

Cover board 1 to board 3, 5 and 4 using wooden dowel(D), add cam lock(C) into board 3,4,5 and turn clockwise to tighten as shown.

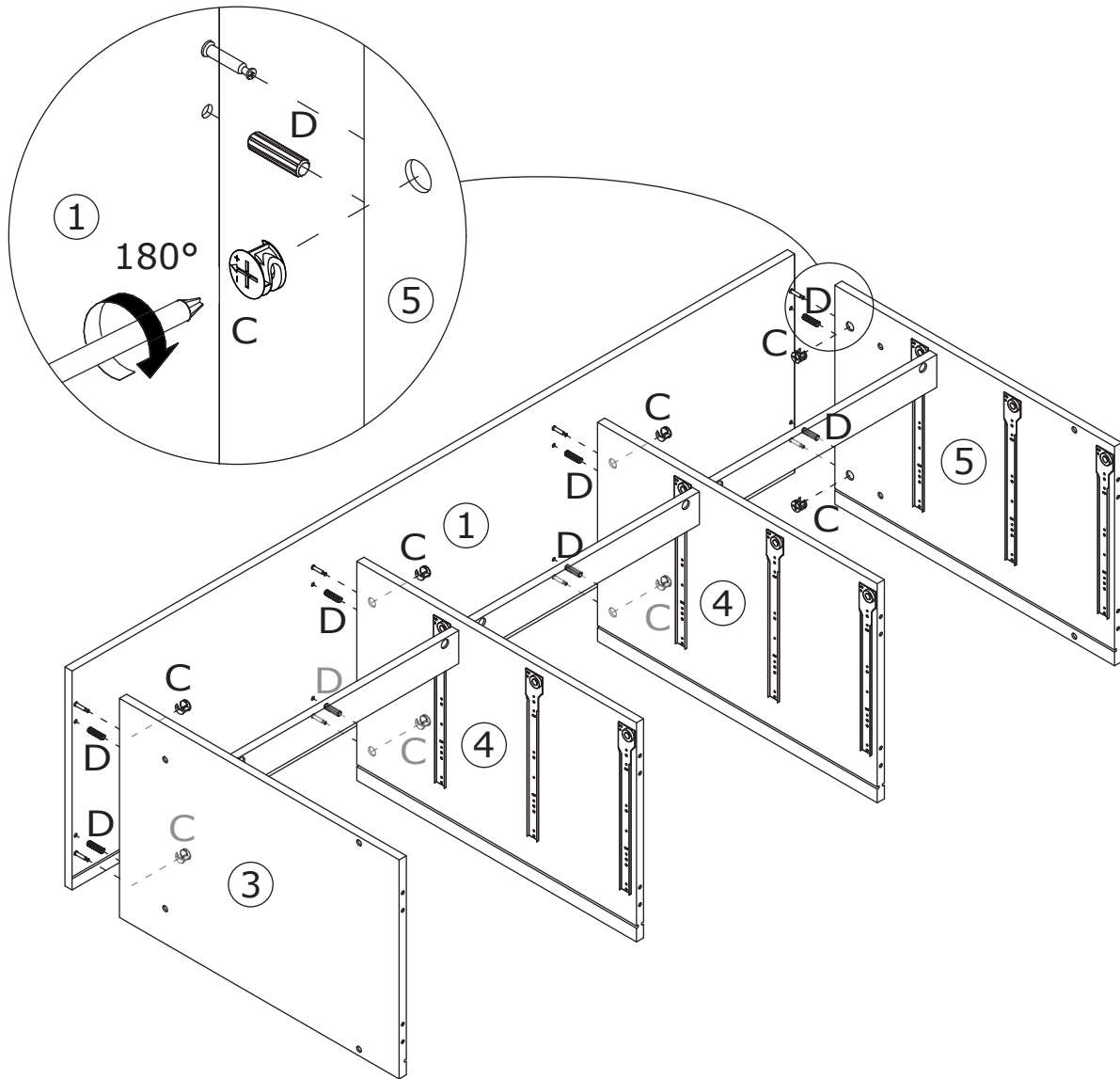
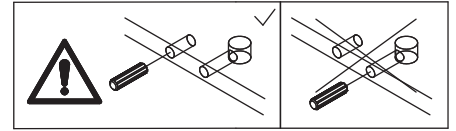
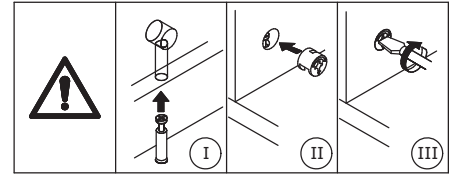

7



Insert back board 7 along available grooves as shown.

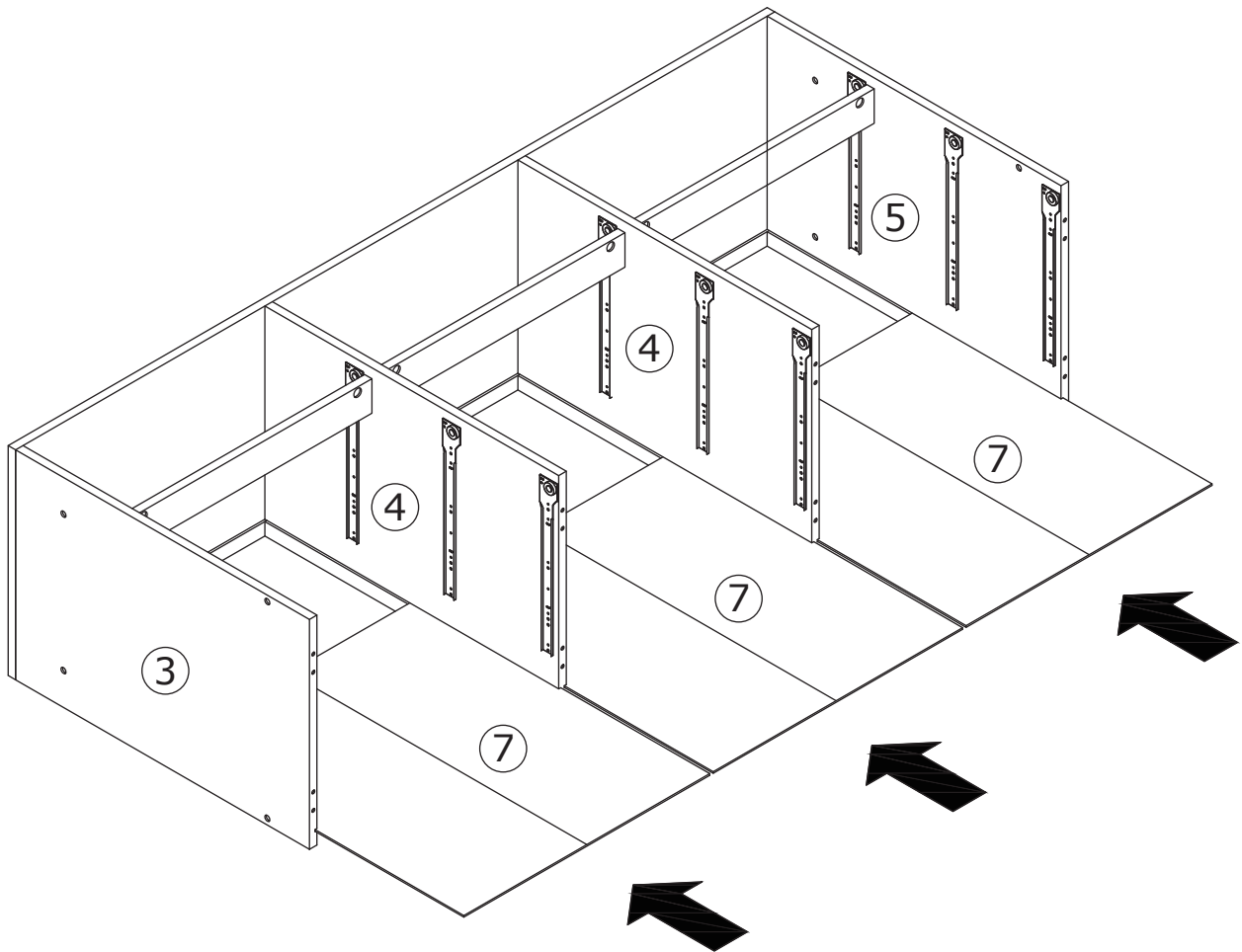

8



Attach board 2 to board 3, 4 and 5 using wooden dowel(D), and fix with screw(A) as shown.

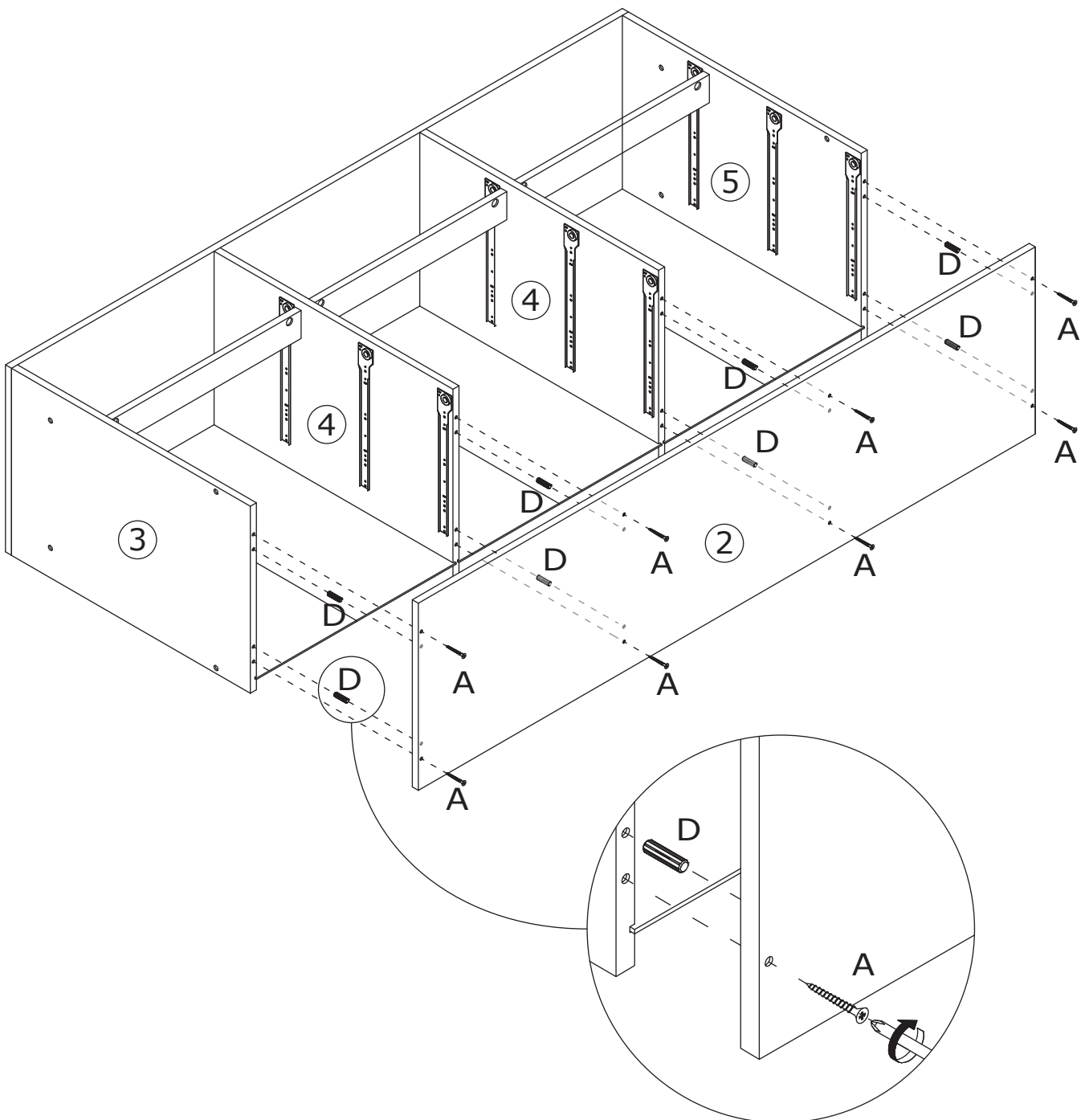
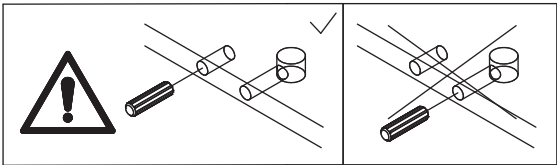

9

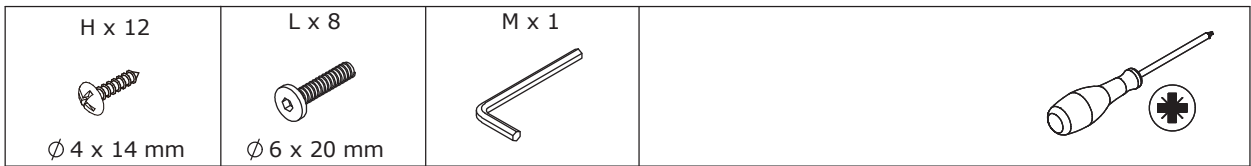

Fix metal frame 8 to board 3; metal frame 8 to board 5 using screw(L) as shown.  
Fix both metal frame 8 to board 2 using screw(H) as shown.  
Fix leg support 14 to board 2 with screw(H) as shown.

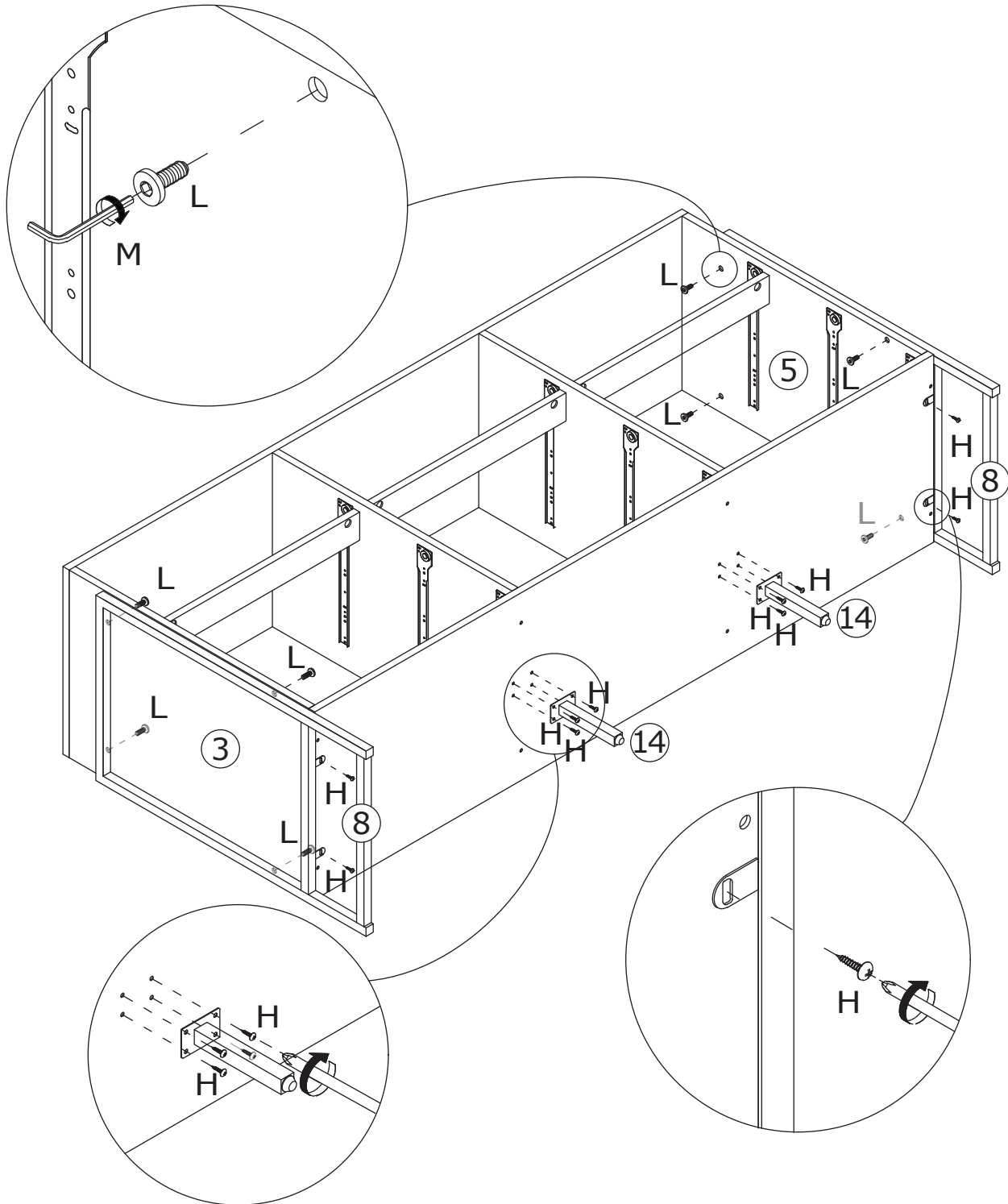

10

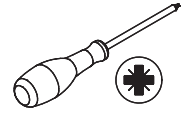
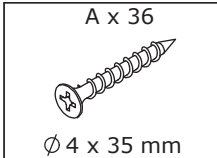

Fix board 9 and 10 to board 11 with screw(A) as shown.

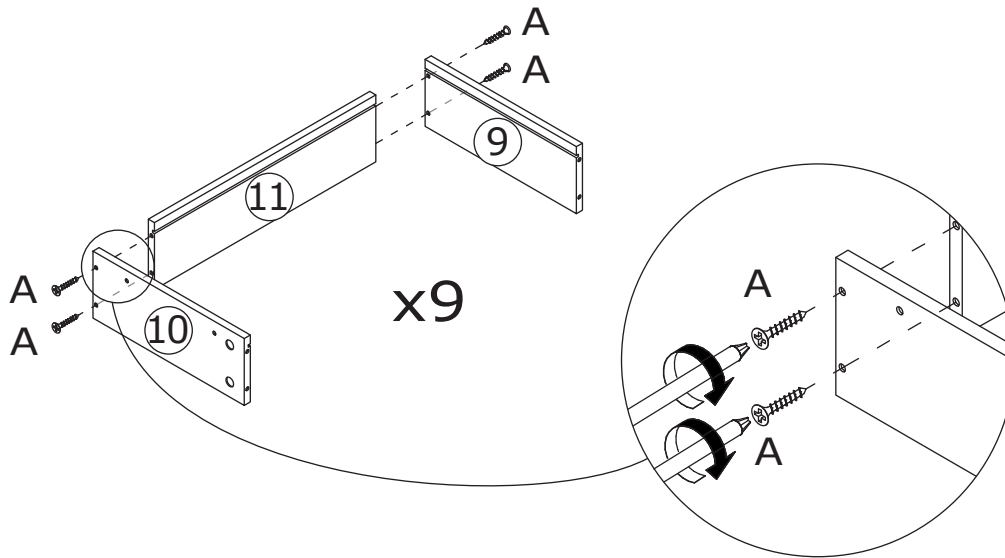

11

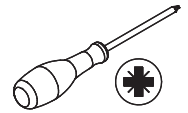
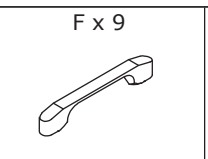
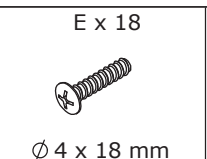
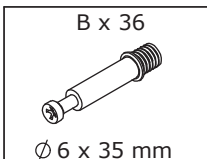

Insert bottom board 12 along grooves at first.  
Screw eccentric rod(B) into board 13, fix handle(F) with screw(E) as shown.

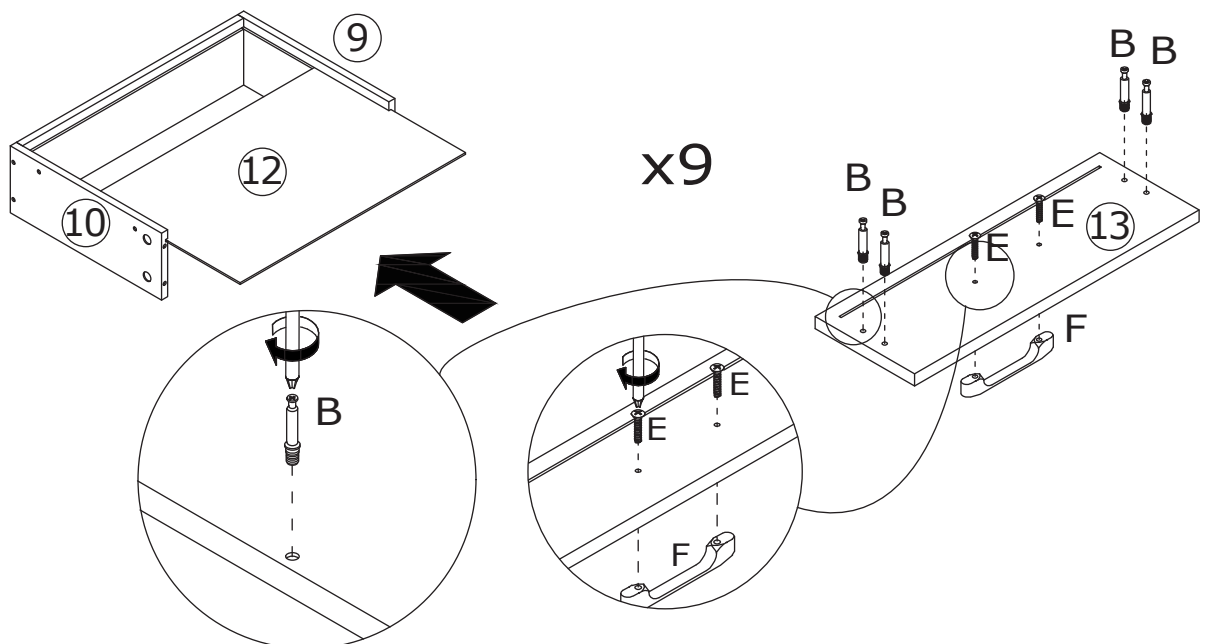
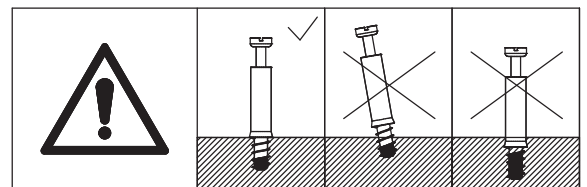

# 12

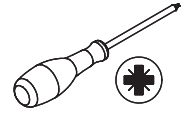
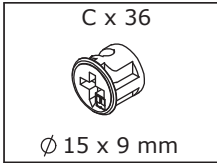

Attach board 13 to board 9 and 10, add cam lock(C) into and turn clockwise to tighten as shown.

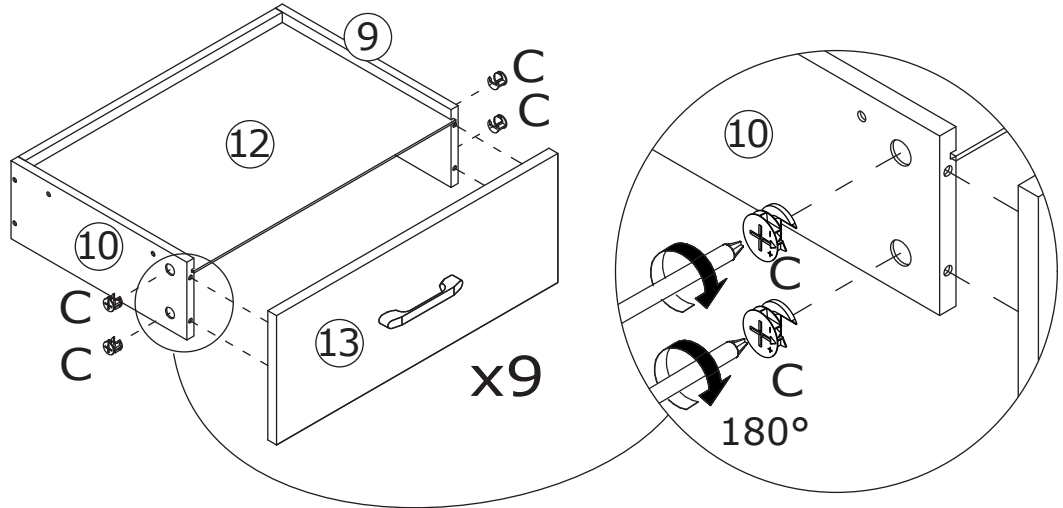
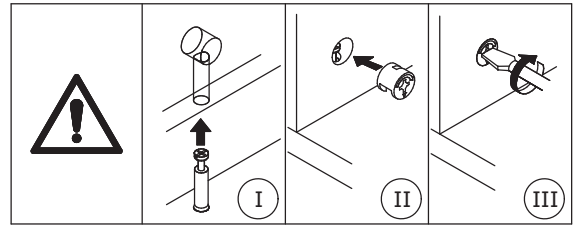

# 13

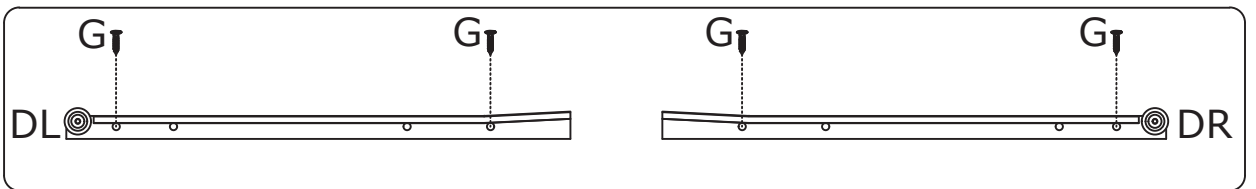
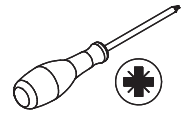
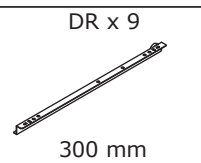
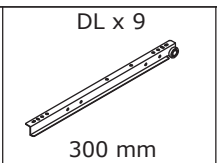
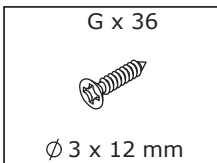

Fix runner(DL) and (DR) to board 9 and 10 with screw(G) as shown.

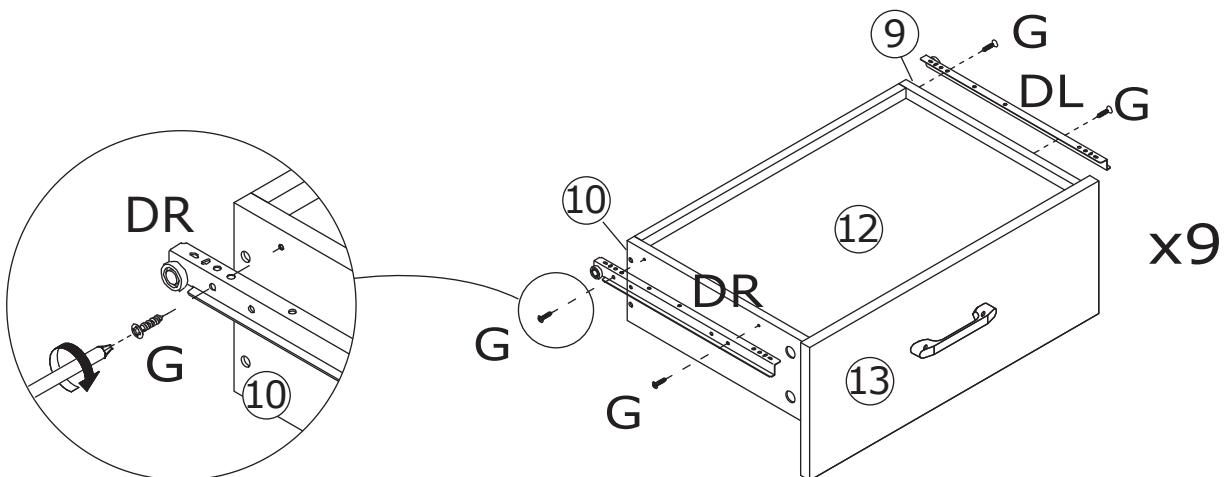



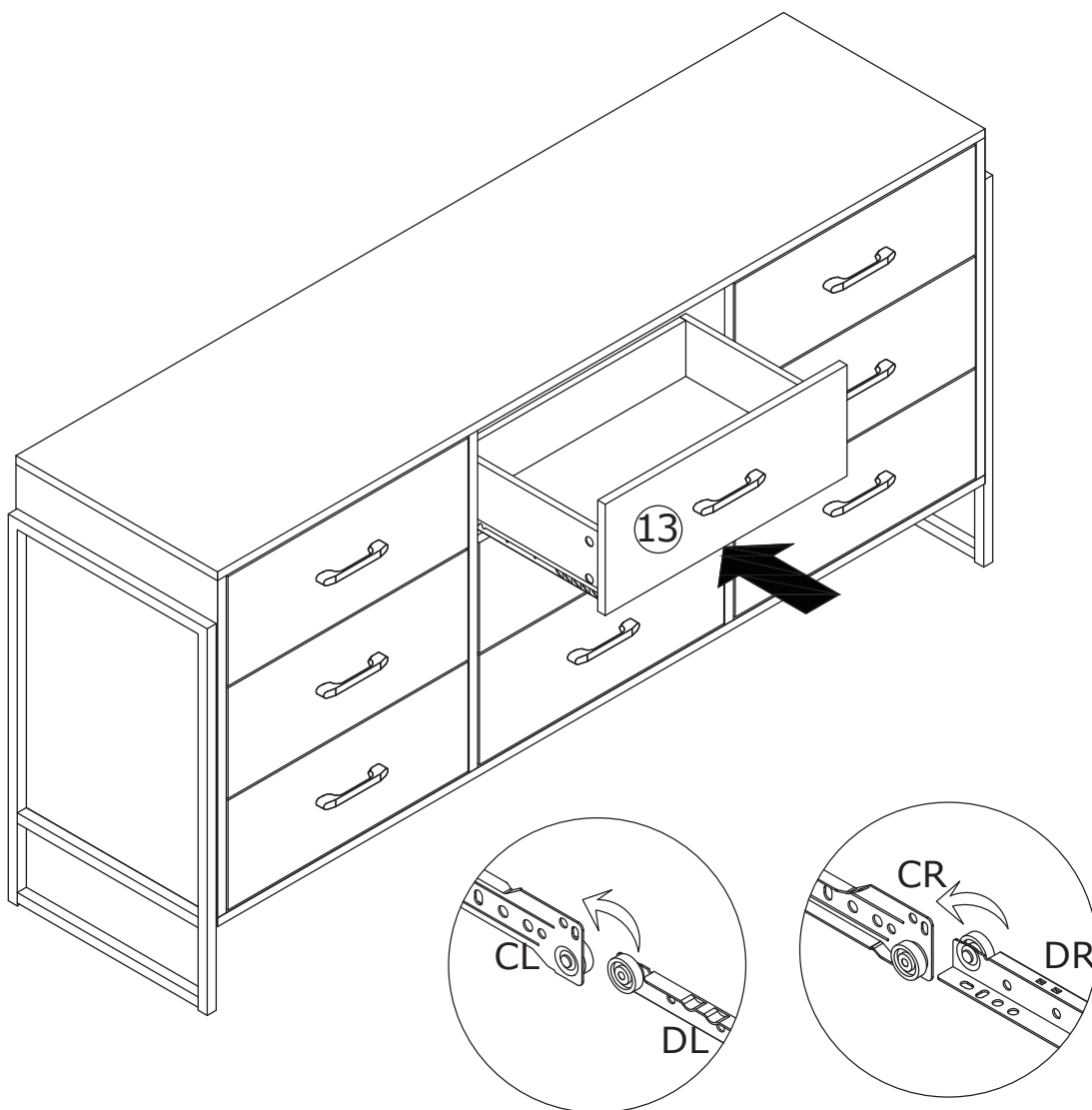

14

Align rails, insert all drawers in.

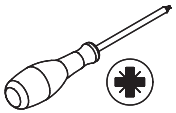

15

H x 2  Ø4 x 14 mm	I x 12  Ø3 x 16 mm	J x 12 	N x 2 	P x 2 	
----------------------------------------------------------------------------------------------------------	-----------------------------------------------------------------------------------------------------------	---------------------------------------------------------------------------------------------	--------------------------------------------------------------------------------------------	----------------------------------------------------------------------------------------------	-------------------------------------------------------------------------------------

Insert buckle(J) into back slots and fix with screw(I) as shown.  
Fix strip(N) to back of board 1 through washer(P) and screw(H) as shown.

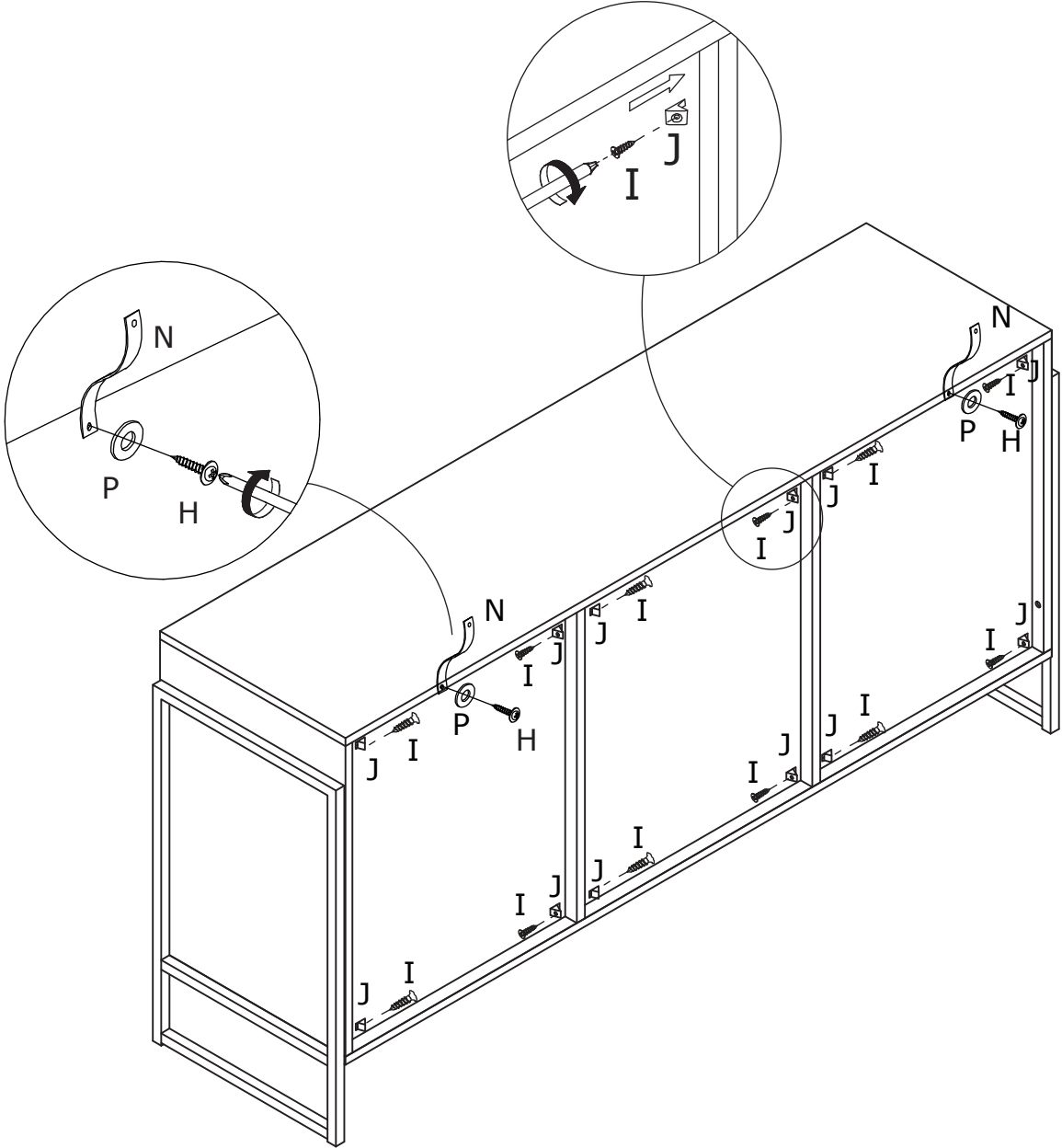

16

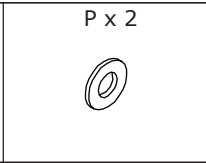
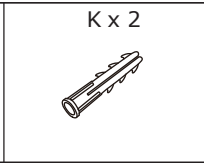
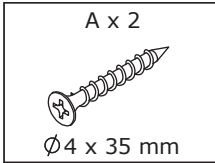

Install anti-tipping device as shown.

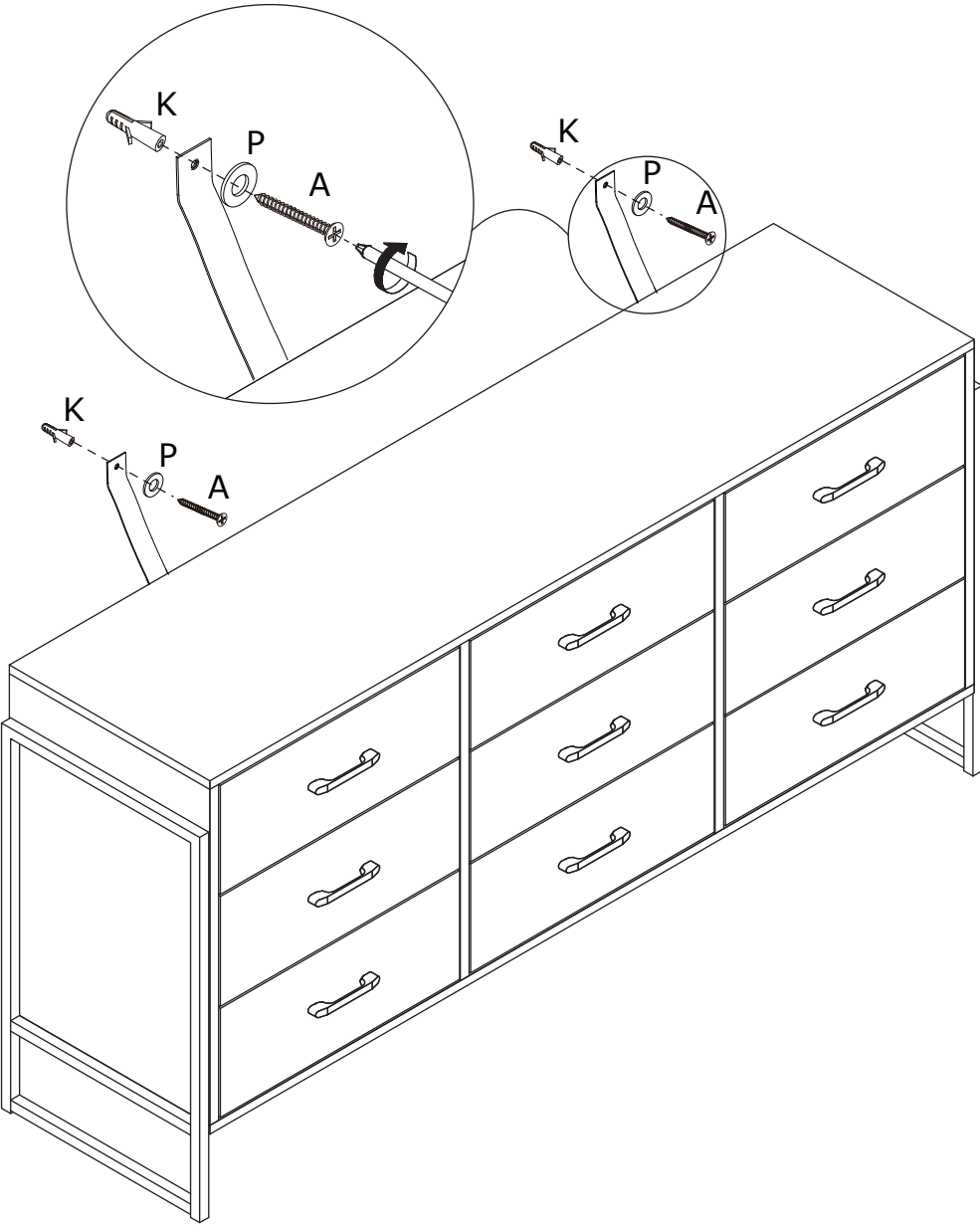

# WARRANTY

## WARRANTY CLAIMS

- There is a 30-day warranty for broken furniture or any other problems that do not work properly. The warranty will start from the date of purchase which must be verified by proof of purchase.
- Before making a claim, we may be able to answer your query, simply call us. Please leave your purchase order number, along with some details of the problem, if you want a replacement part. We will arrange within 48 hours. If there is out of stock, we will reply with a shipping date.
- The product must be used in accordance with the instructions provided. For health reasons.
- For other reasons, if the furniture needs to be returned, it must be cleaned and dried and operated within 30 days of receipt.

## Type of Warranty Claim

- Failure to follow the furniture instructions will invalidate the warranty. Attention please.
- Does not include damage during installation, but includes damage during transportation.

## Scope of responsibility

- Shall not bear any responsibility for misuse or user damage and / or loss of parts during the installation of furniture.
- After using, the damage and scratches of the furniture are not covered by the warranty.

## The Warranty Relates to All Bought in The Us and Covers The Following Areas

- Sheet parts: 1 month from the date of purchase.
- Electrical parts: 1 month from the date of purchase.