

- (D) Montageanleitung
- (NL) Handleiding voor de montage
- (TR) Montaj talimatı
- (F) Notice de montage
- (CZ) Montážní návod
- (GB) Assembly instructions
- (HU) Szerelési útmutató
- (PL) Instrukcja montażu
- (RU) Инструкция по монтажу
- (IT) Istruzioni di montaggio
- (SK) Návod na montáž
- (RO) Instrucțiuni de montaj

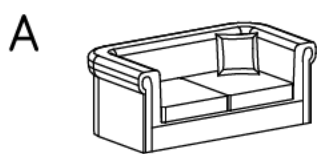

x1

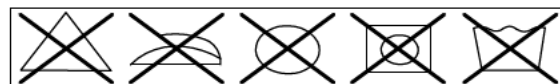
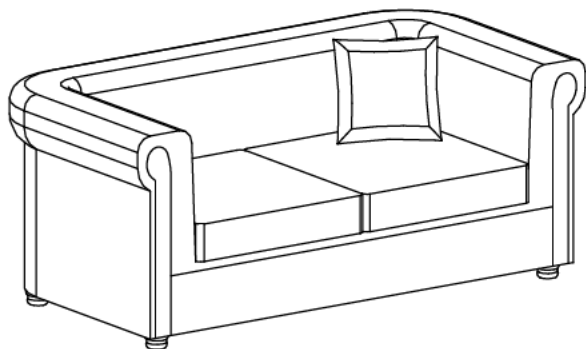

x4

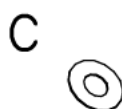

x4



x1

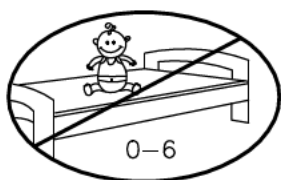

0-6

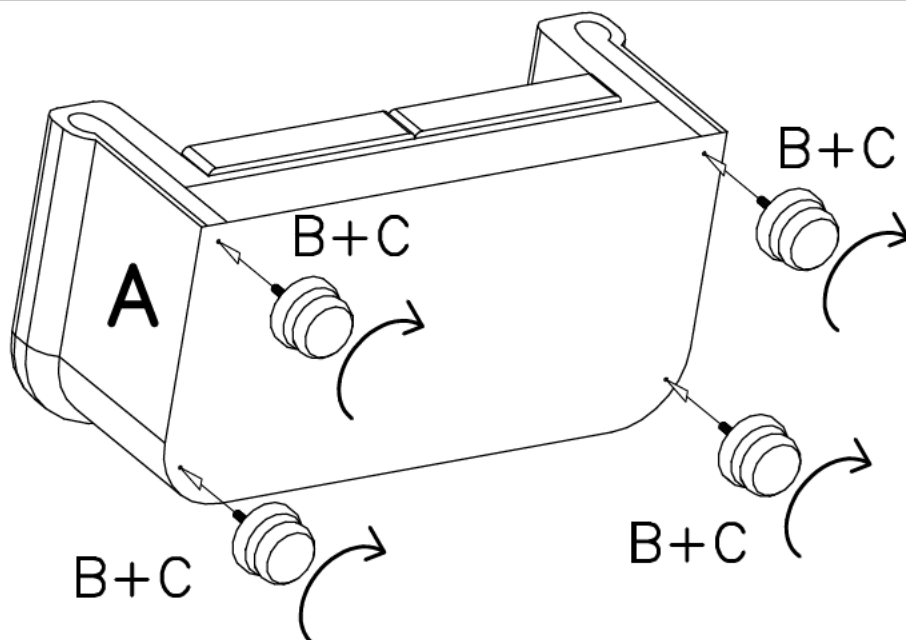
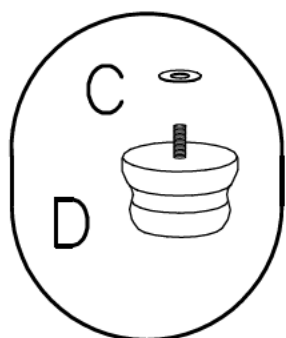
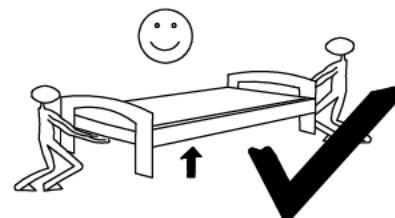
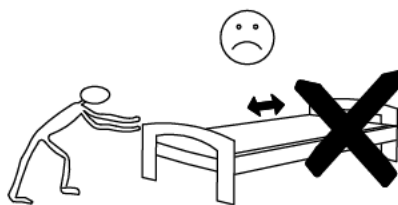
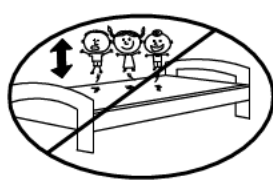

Service • Assistenza • Dienstverlening • Serwis •  
 Servis • Szerviz • Сервисная служба

Name • Nom • Nome • Naam •  
 Nazwa • Имя • Имя • Név •  
 Denimire • Isim • Имя

Nr • No. • N° • Номер • Č • Sz

Type • Tipo • Típus • Тип •  
 Тип • Тр

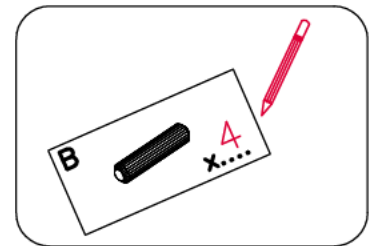
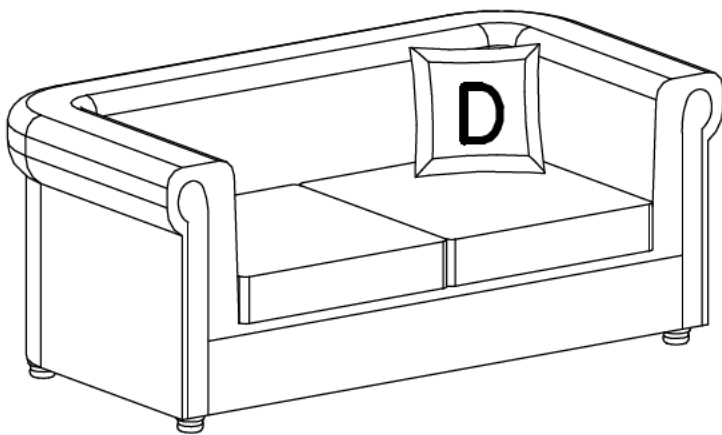
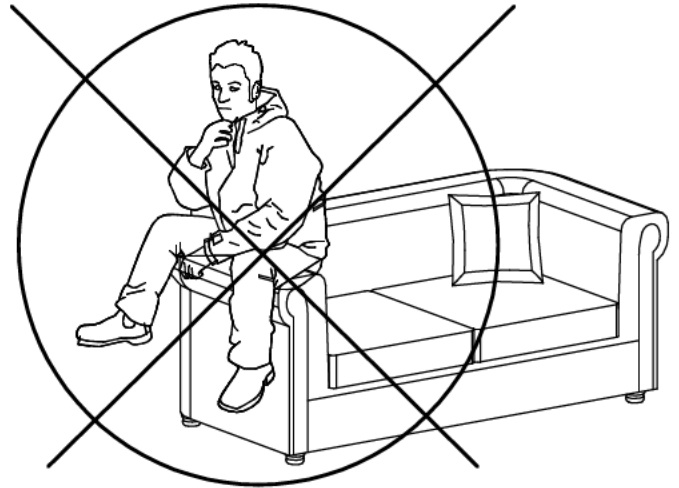
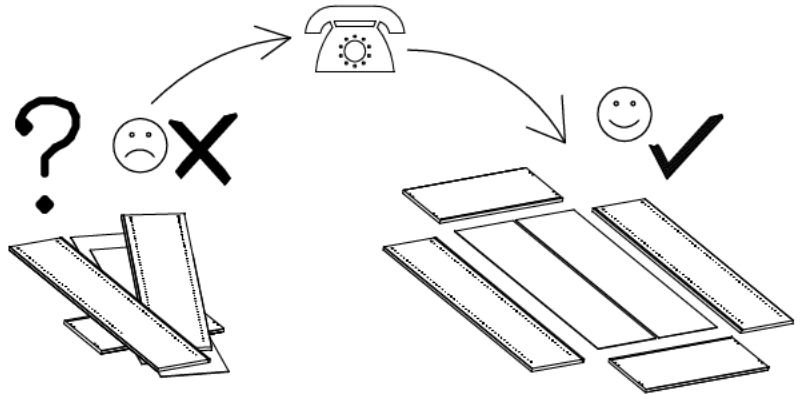
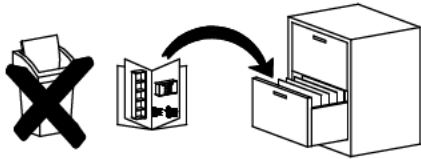

A



X...

B



X...

C



X...

D



X...