

BEDSIDE TABLE

ASSEMBLY GUIDE

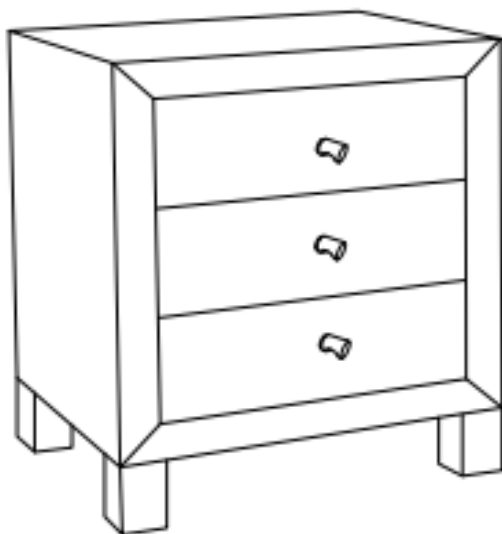

Important - Please read these instructions fully before starting assembly



**SAFETY AND
CARE ADVICE**



NO POWER TOOLS

SAFETY AND CARE ADVICE

- Check you have all the components and tools listed.
- Remove all fittings from the plastic bags and separate them into their groups.
- We do not recommend the use of power drills/drivers for inserting screws, as this could damage the unit. Only use hand screwdrivers and Allen keys.
- Keep children and animals away from the work area, small parts could cause choking if swallowed.
- Make sure you have enough space to layout the parts before starting.
- Assemble the item as close to its final position (in the same room) as possible.
- Do not overtighten the nuts to avoid causing damage to the threads.
- Only clean using a damp cloth and mild detergent, do not use bleach or abrasive cleaners.
- From time to time check that there are no loose screws on this unit
- This product should not be discarded with household waste. Take to your local authority waste disposal centre

IMPORTANT INFORMATION



30 MINUTE
BUILD



TWO
PERSON





MAXIMUM
CAPACITY 66Kg



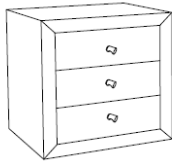

GLASS





PLEASE CHECK CAREFULLY AND MAKE SURE YOU HAVE ALL FITTINGS AND TOOLS LISTED BELOW BEFORE YOU START.

DESCRIPTION	PART NAME	QTY (PCS)
①		1
②		4

Parts for Leg Assembly

(A)		BOLT 30MM	8 PCS
(B)		WASHER	8 PCS
(C)		ALLEN KEY	1 PC

Parts for Drawer Knob Assembly

A		BOLT 30MM
B		METAL WASHER
C		SILICONE WASHER
D		KNOB

NOTE: The quantities above are the correct amount to complete the assembly. In some cases more fittings may be supplied than are required.

STEP 1

Use a clean, flat, soft surface to avoid any bumps or scratches.

Place your bedside table upside down. Attach 4x legs [2] using 2x washers [B] followed by 2x screws [A] on each leg - 8 of each in total. Tighten using Allen key [C].

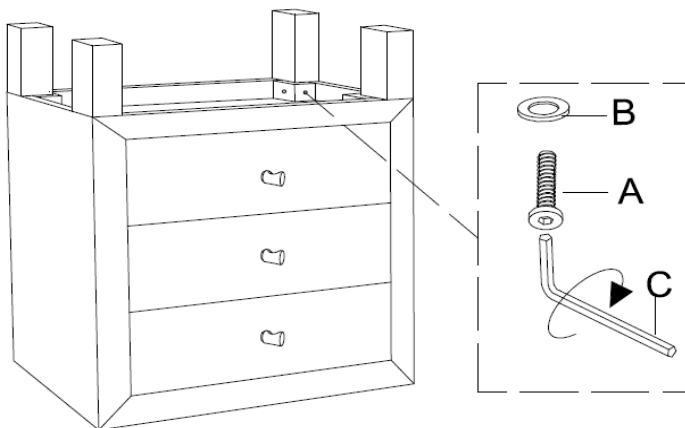
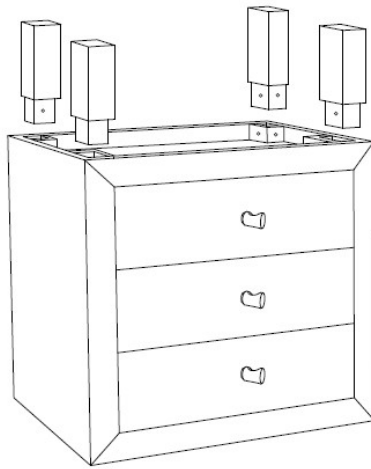

STEP 2

Stand your bedside table on its feet.

Remove drawer knobs from back side of the drawer.

Place 1 x silicone washer [C] between drawer knob [D] and the drawer surface. Attach from inside drawer using 1 x metal washer [B] and 1 x bolt [A]. Be careful not to over-tighten. Repeat for all drawers and drawer knobs.

Your bedside table is now complete.

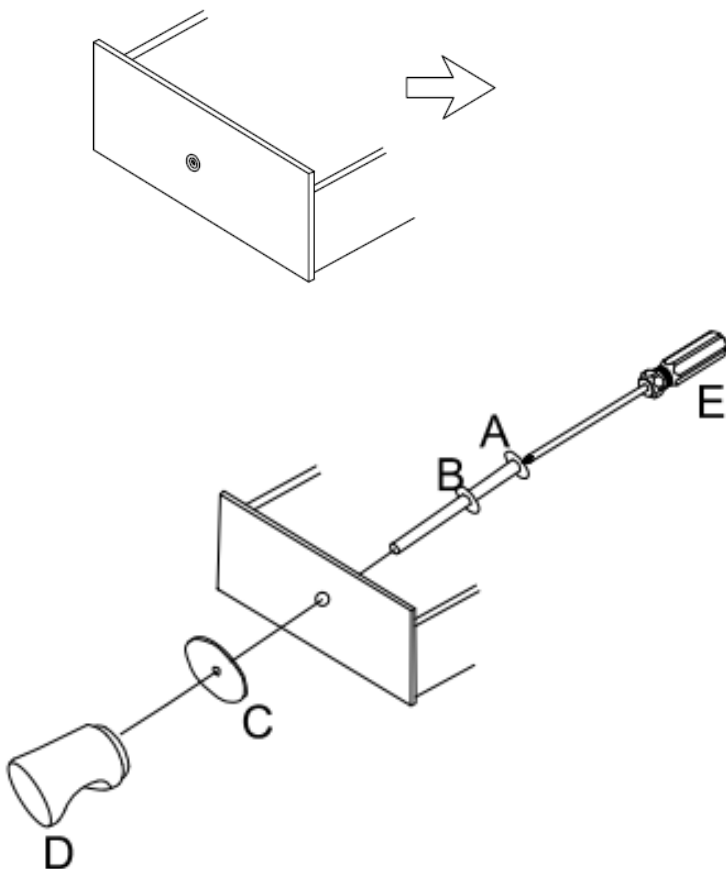

Anti Tipping Kit Instructions

Warning: Unfixed furniture may tip over. We strongly advise you use the anti-tipping kit provided to secure your bedside table to the wall. Please use appropriate fixings for your wall and get professional advice if unsure.

Hardware

- 1 Metal Strap (A)
- 2 Hoops (B)
- 1 Pull Ring (C)
- 1 Wall Bracket (D)
- 2 Screws (E)
- 2 Wall Plugs

STEP 1

Put pull ring [C] into wall bracket [D].

Position the bracket on your wall and mark the holes to be drilled. We recommend the bracket is fitted just below the top of your unit so that it is not visible when the unit is in place.

Attach bracket [D], with pull ring [C] now in place, to the wall using 2 x screws [E] and wall plugs.

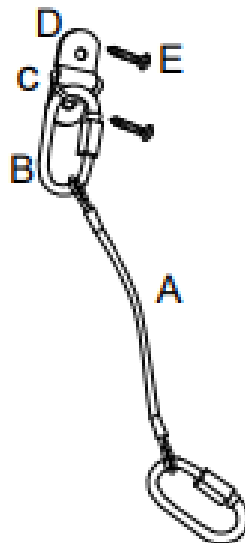

STEP 2

Attach the strap [A] to the back of the unit using 1 x Hoop [B]. Ensure the Hoop [B] is locked.

Carefully position your bedside table and attach the free end of strap [A] to the pull ring [C] attached to the wall. Attach strap to pull ring on wall using the other Hoop [B]. Ensure Hoop [B] is locked.

Ensure everything is secure. Your bedside table is now secured to the wall!

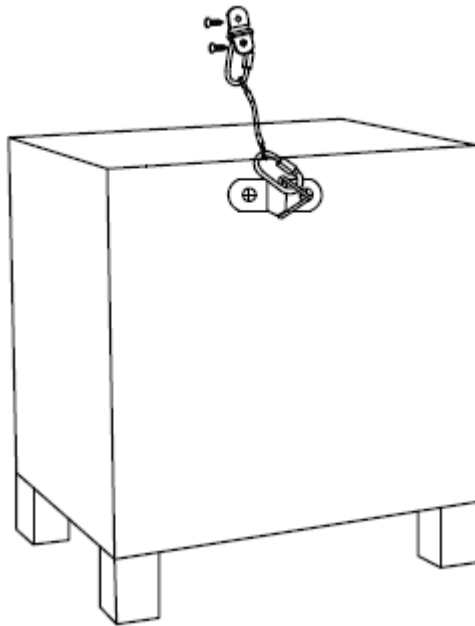



OUR 2 YEAR* GUARANTEE

our products come with a 2 year guarantee to give you peace of mind shopping

*excludes some garden furniture items which have a 1 year guarantee



WHAT THE GUARANTEE COVERS



PRE-INSERTED FIXINGS
e.g. lose metal threads



FAULTY JOINTS
e.g. legs bending



EXTERNAL FIXING FAULTS
e.g. bonding/glue



STRUCTURAL INTEGRITY
e.g. the frame of the product