

Installation Instruction

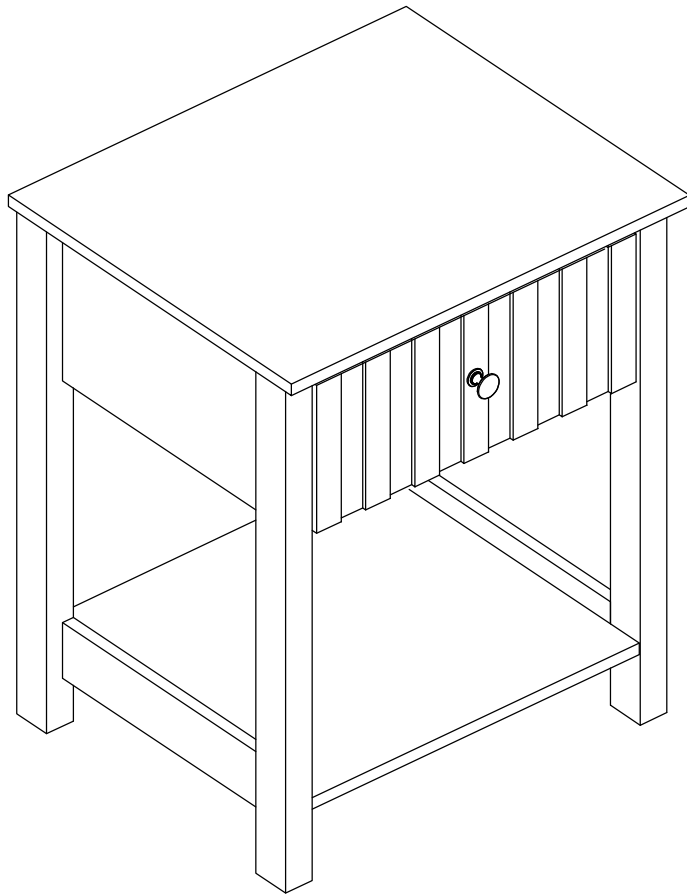

Assembling

What you need

- Use the packaging carton as a working surface to prevent product damage during assembly
- Phillips head screwdriver

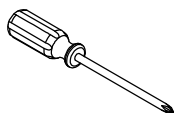

Weight Limitation

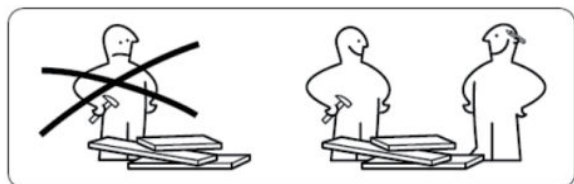

What' included

Code	Description	Qty
A	Cam Bolt M6X35MM	30
B	Cam Lock 15X10MM	30
C	Wooden Dowel M6X30MM	24
D	Screw M4X40MM	4
E	Screw M4X18MM	1
F	Round handle	1
G	MATS	4
H	Screw M3.5X12MM	10
I	Hole position sticker	4
CL	Left mother extended orbit	1
CR	Right mother extended orbit	1
DL	Left public extension track	1
DR	Right public extends track	1

The Hardware

A

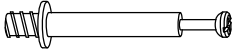

B

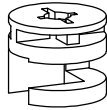

C

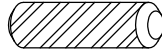

D

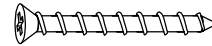

E



F



G



H



I

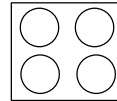

CL

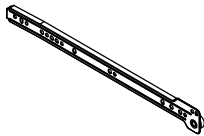

CR

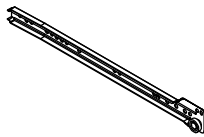

DL

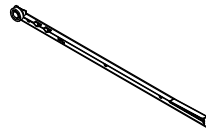

DR

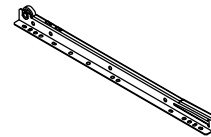

IMPORTANT:

1. Do not tighten bolts / screws completely until all bolts / screws are lined up and inserted into holes.
2. Do not over tighten screws and bolts to avoid stripping
3. Please use hand tools to assemble this product, you can also use power tools (please use power tools carefully).

Included Accessories

Code	Description	Qty
1	Cabinet Top	1
2	Bottom Panel	1
3	Left lateral plate	1
4	Right lateral plate	1
5	Back plate	1
6	Drawer left panel	1
7	Drawer right side panel	1
8	The drawer bottom	1
9	After the drawer board	1
10	The drawer face	1
11	Right hind foot	1
12	Left hind foot	1
13	Left front foot	1
14	Right front foot	1
15	Stiffening plate	2

The Accessoriess

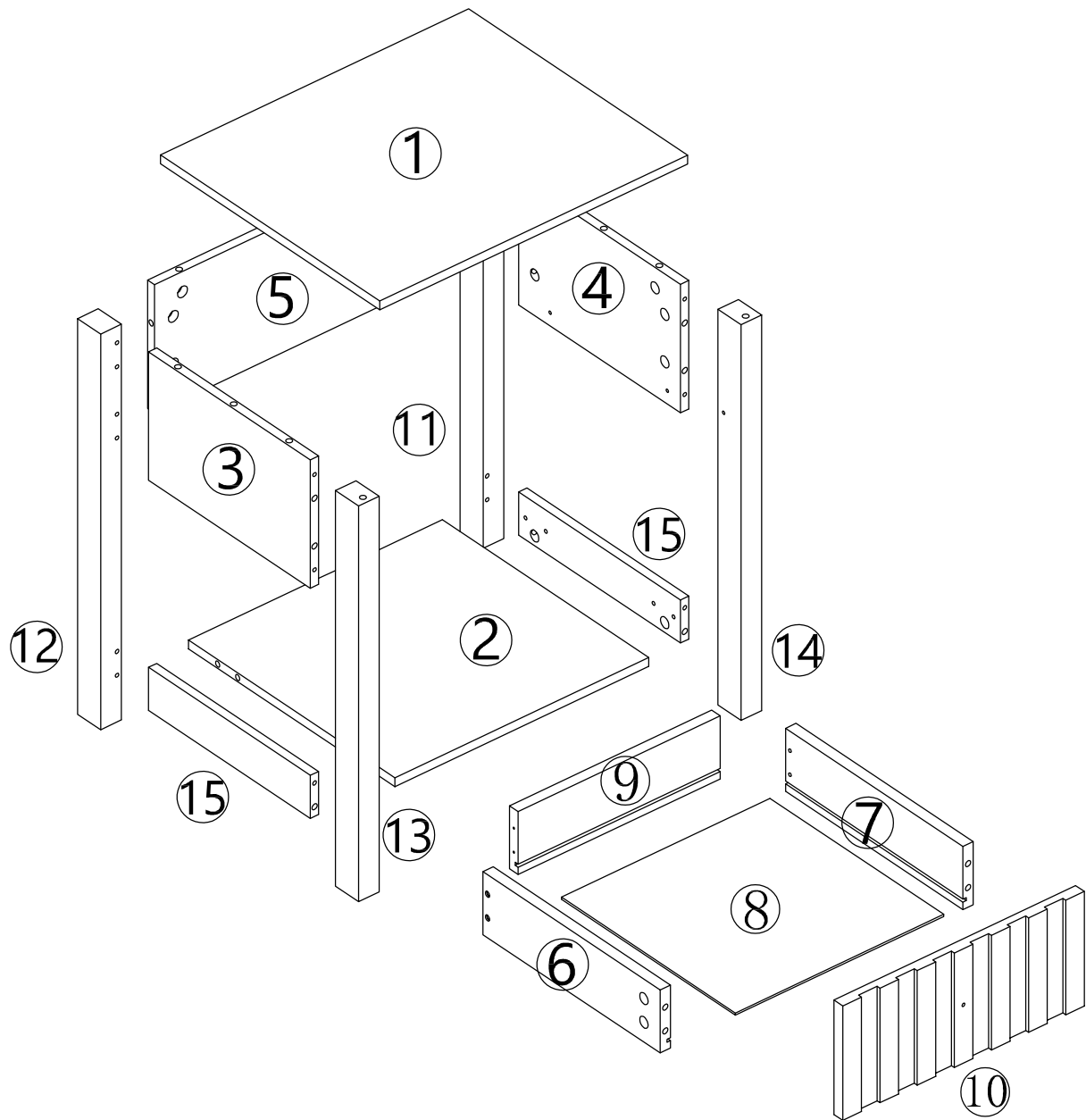

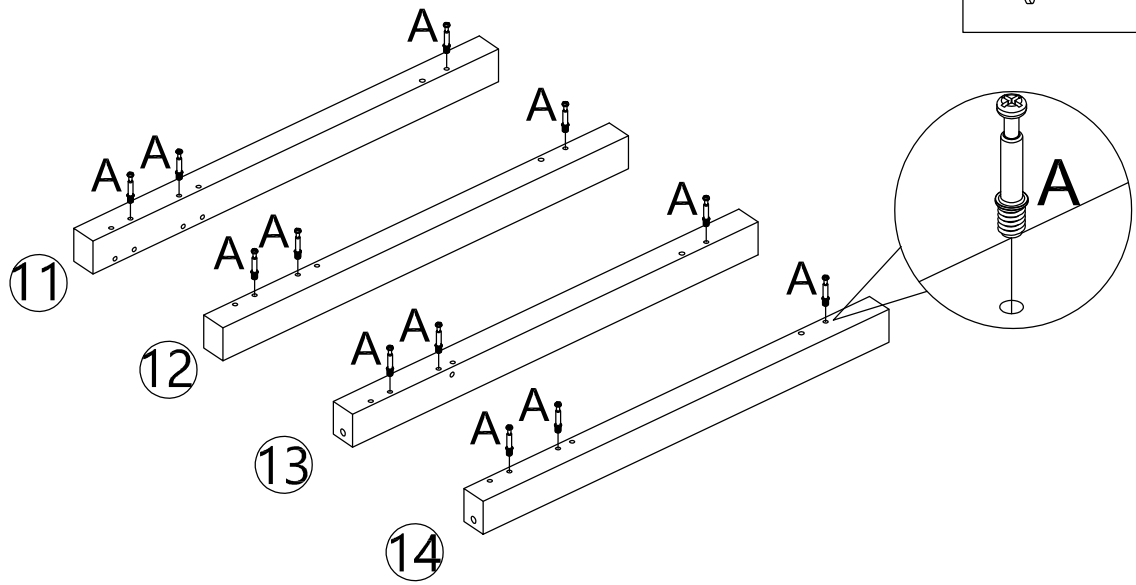

Step 1

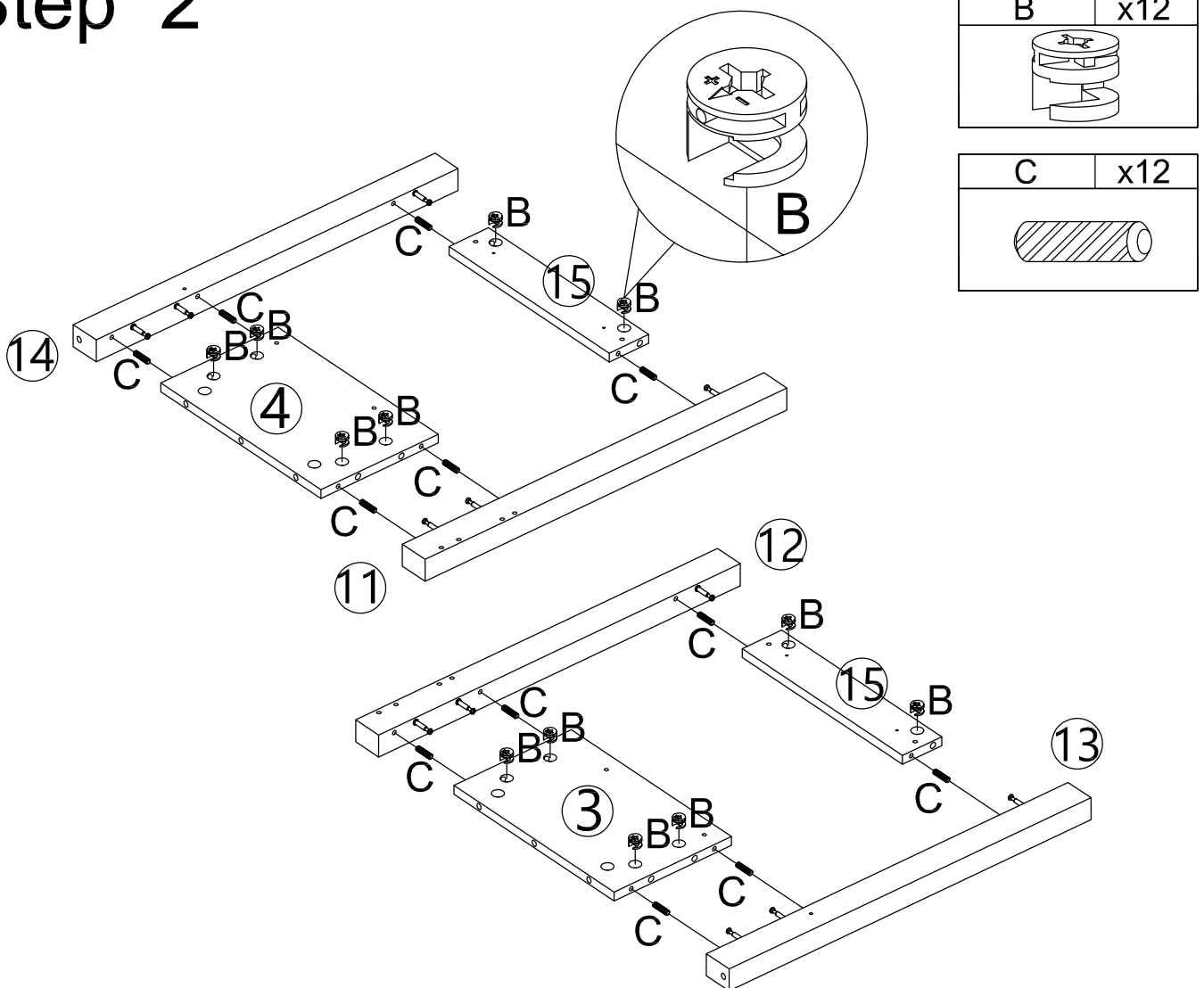

Step 2

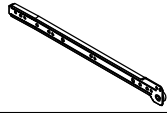
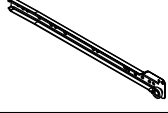
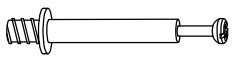

Step 3

CL	x1	CR	x1	A	x8
					
				H	x6
					

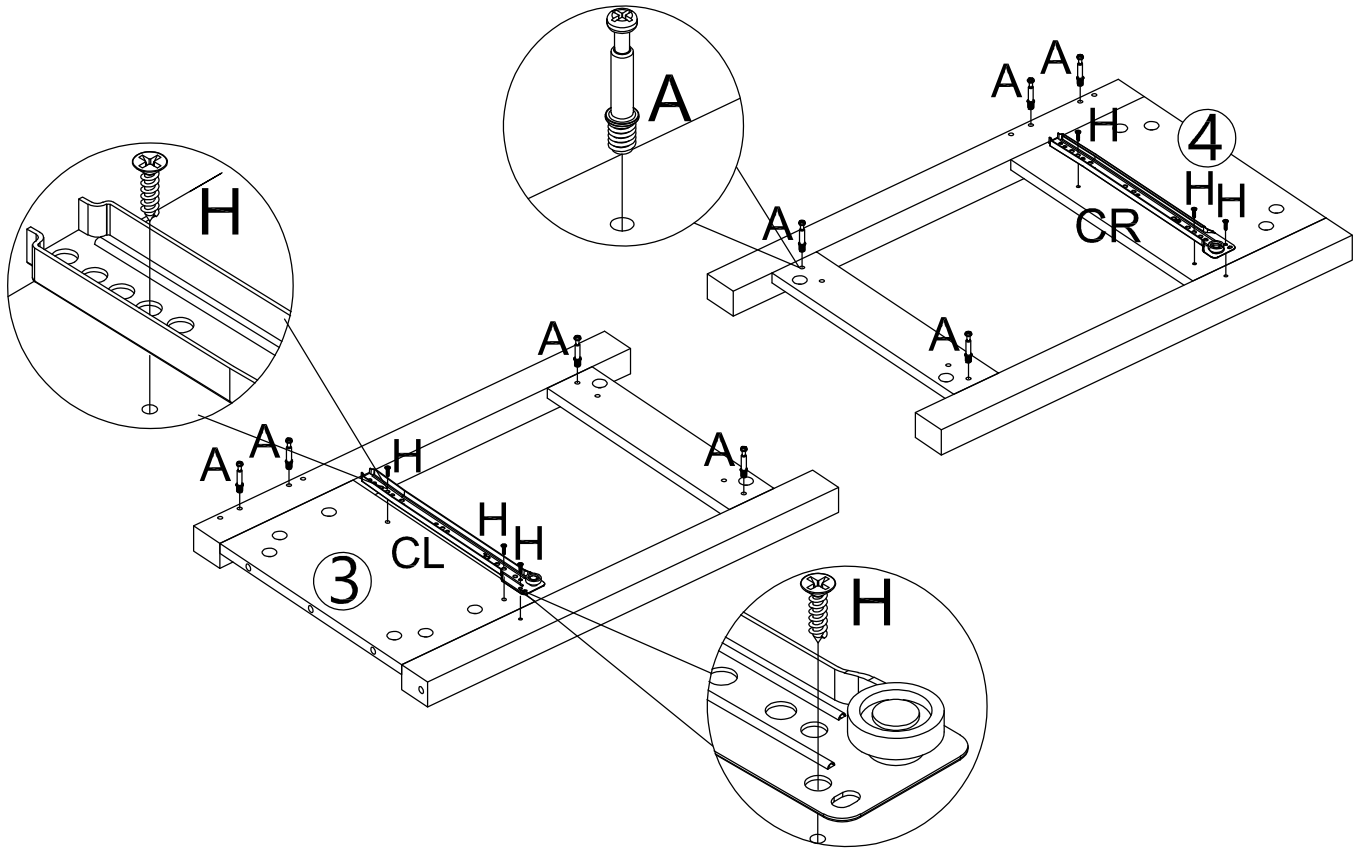
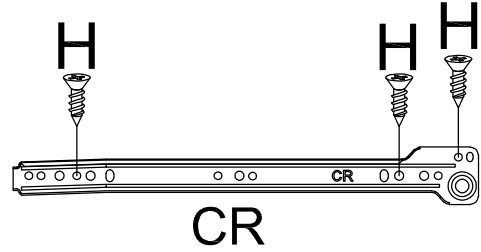
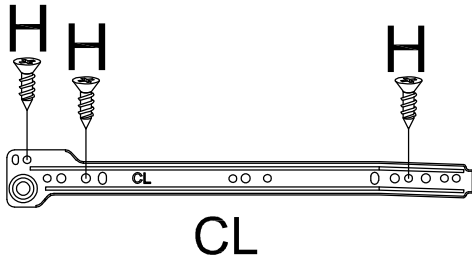

Step 4

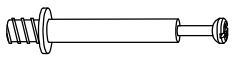
A	x6
	

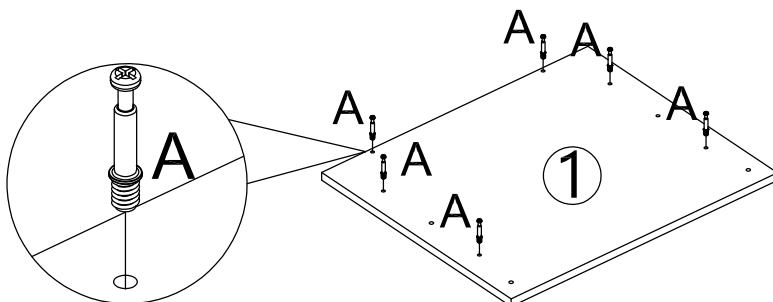

Step 5

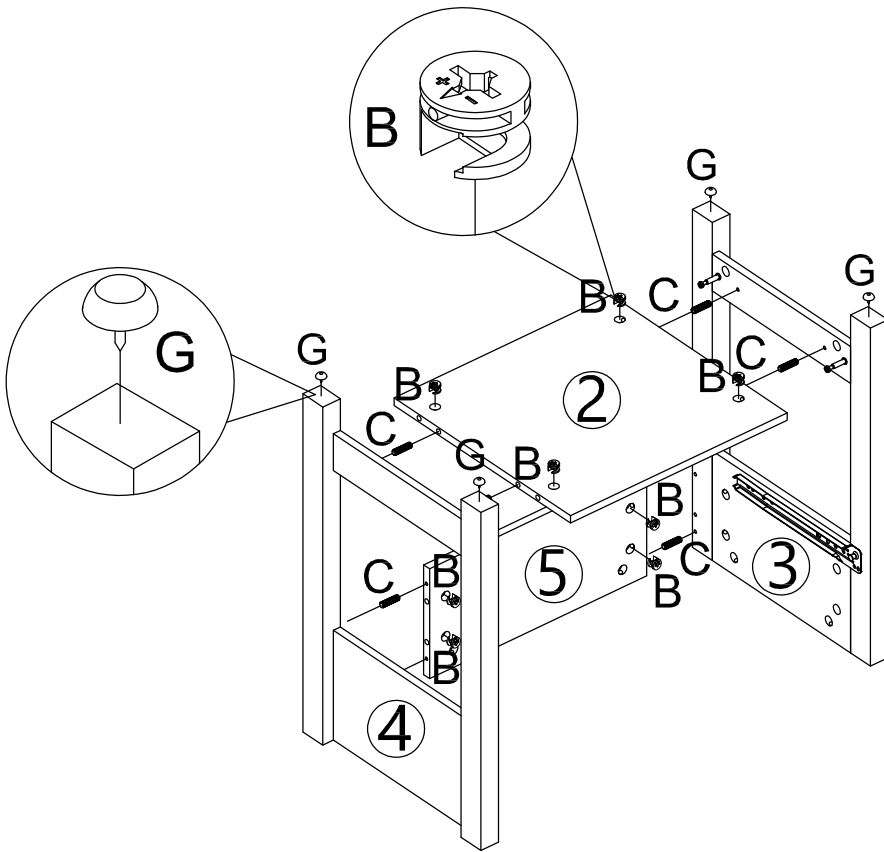

B	x8

C	x8

G	x4

Step 6

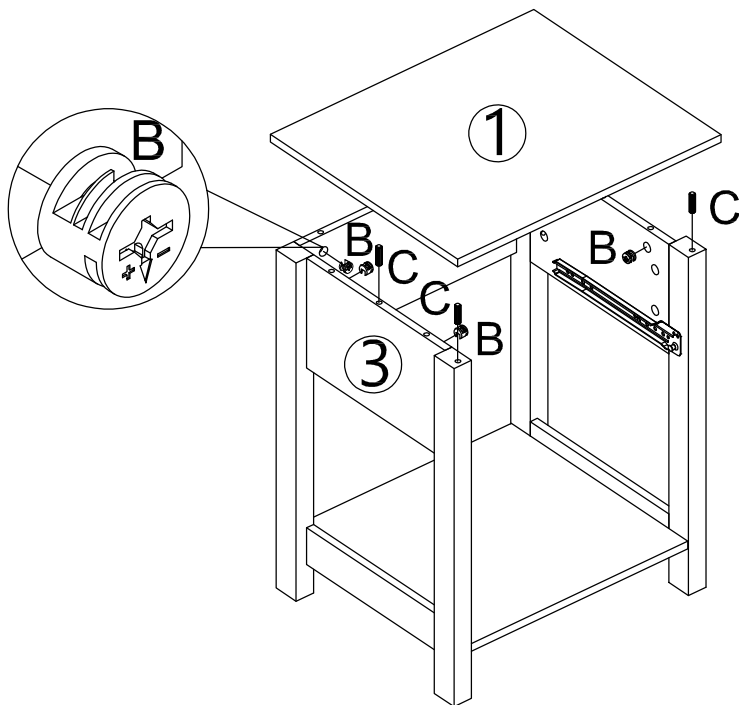

B	x6

C	x4

Step 7

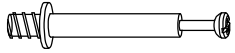
A	x4
	

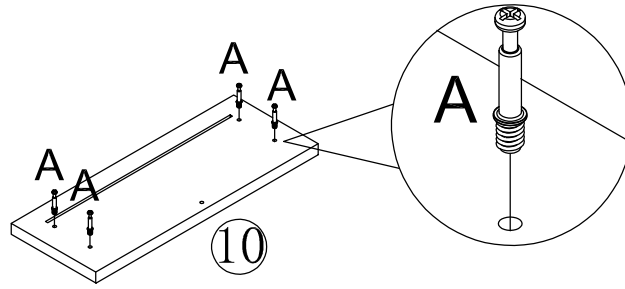

Step 8

I	x4
	

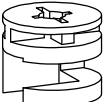
B	x4
	

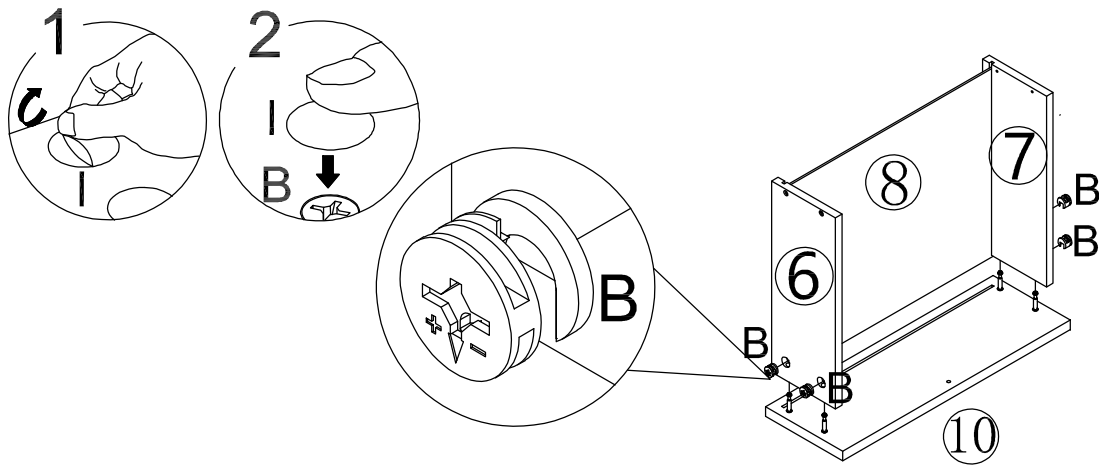

Step 9

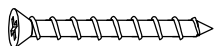
D	x4
	

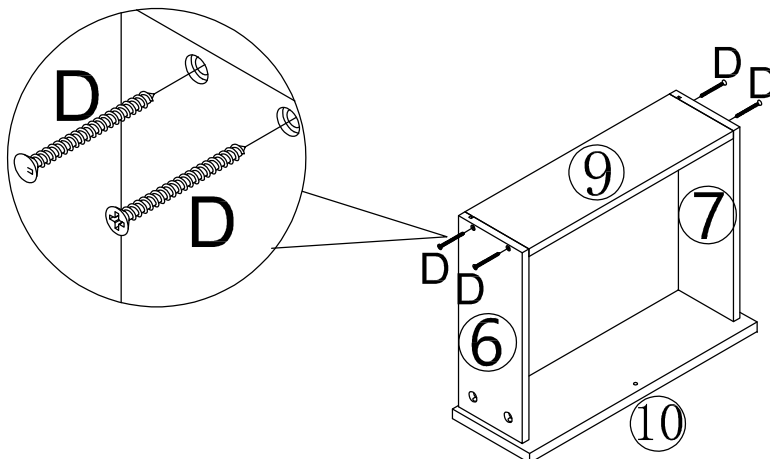

Step 10

DL	x1

DR	x1

H	x4

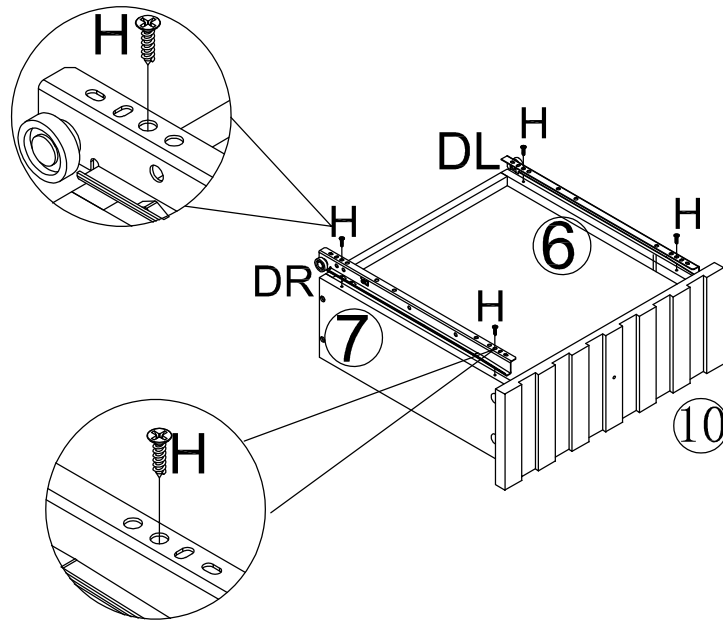
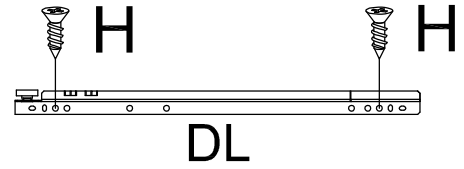
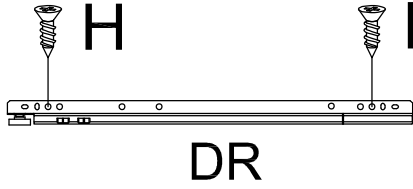

Step 11

E	x1

F	x1

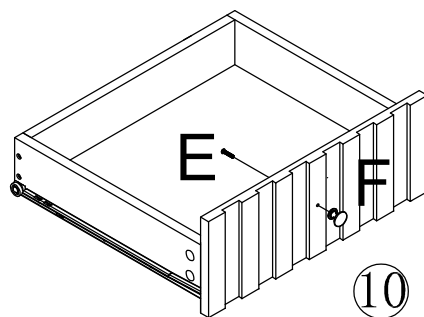

Step 12

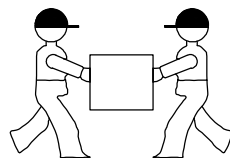
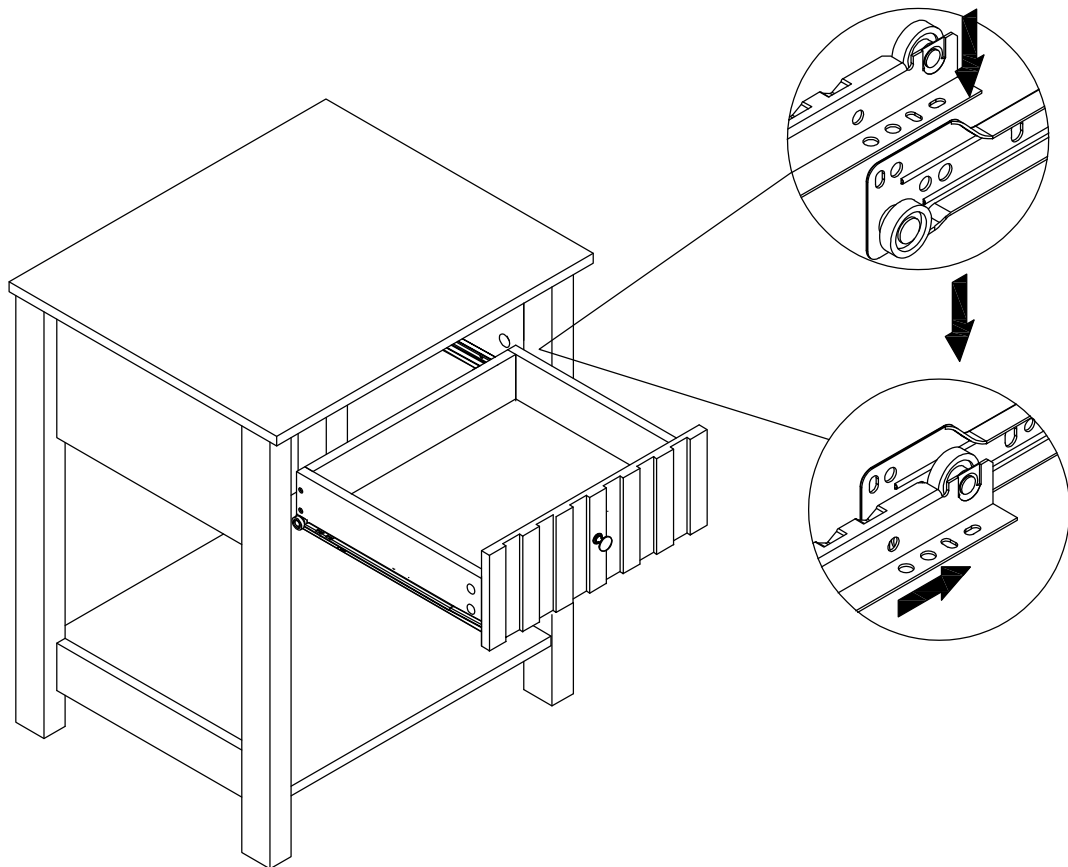

Two people work together to move the table.
Make sure you lift it off the ground.
Don't push and pull.