

Top View

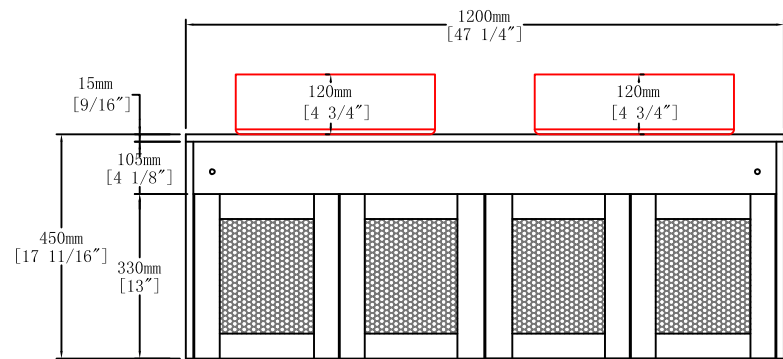

Front View

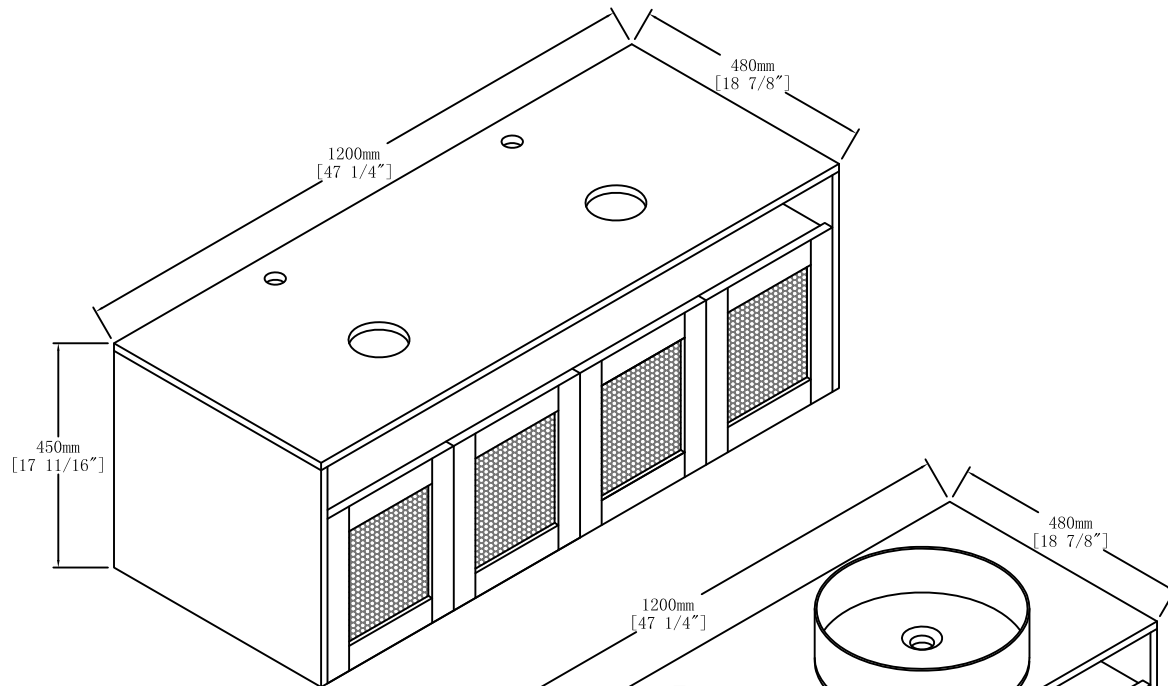
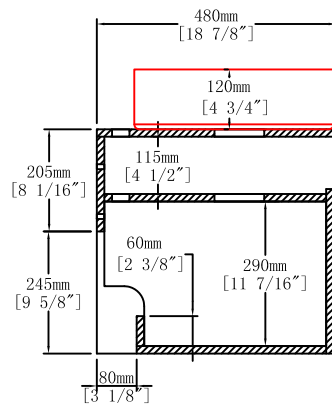

Side View

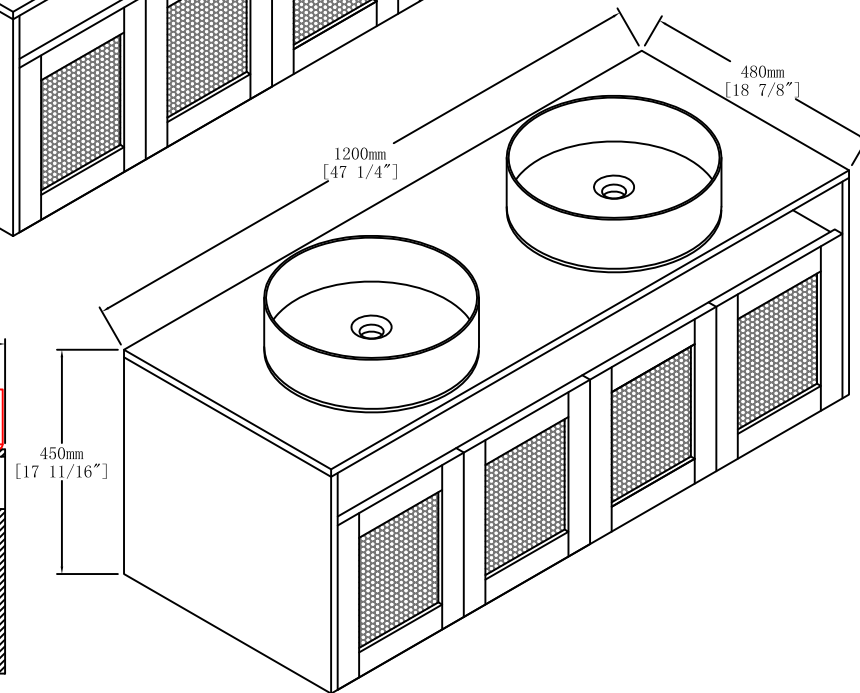

Item NO.

BV B12648

Version

V1

Project

Date

2025-4-19