

ASSEMBLY INSTRUCTION

ITEM NO.N711P415846

CABINET

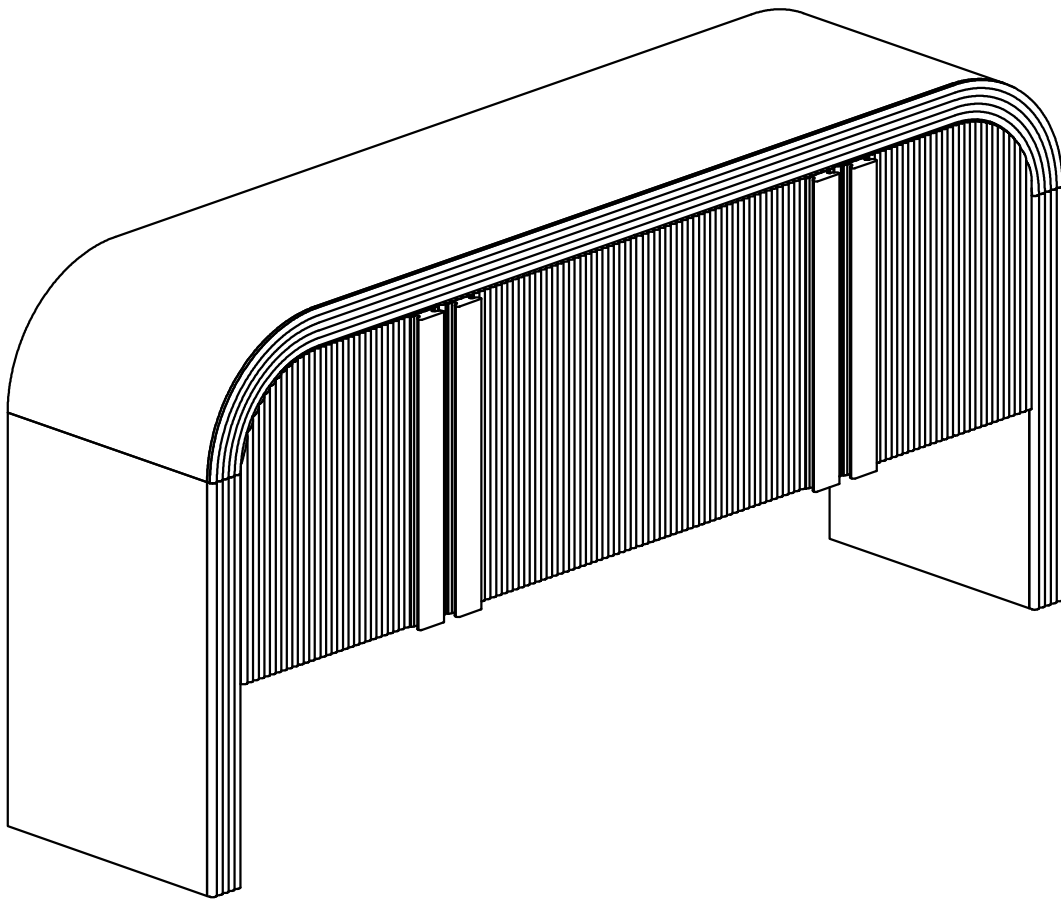

 WARNING	
	<p>This product is NOT a Clothing Storage Unit (CSU). DO NOT use it for clothing storage. Improper use may cause furniture tipover.</p>

ASSEMBLY INSTRUCTION

ITEM NO. **N711P415846**

Please read these instructions fully before starting assembly:

1. Place all wooden parts on a clean and smooth surface such as a rug or carpet to avoid scratching the parts.
2. Kindly follow the assembly instructions step by step.
3. Do not tighten all screws and bolts until the table is fully assembled.
4. Unscrew the protective plastique supports from the metal insert of the table legs before assembly.
5. Parts of the assembly will be easier with 2 people.

Care and maintenance:

Only clean using a damp cloth and mild detergent, do not use bleach or abrasive cleaners.

ASSEMBLY INSTRUCTION

ITEM NO. N711P415846

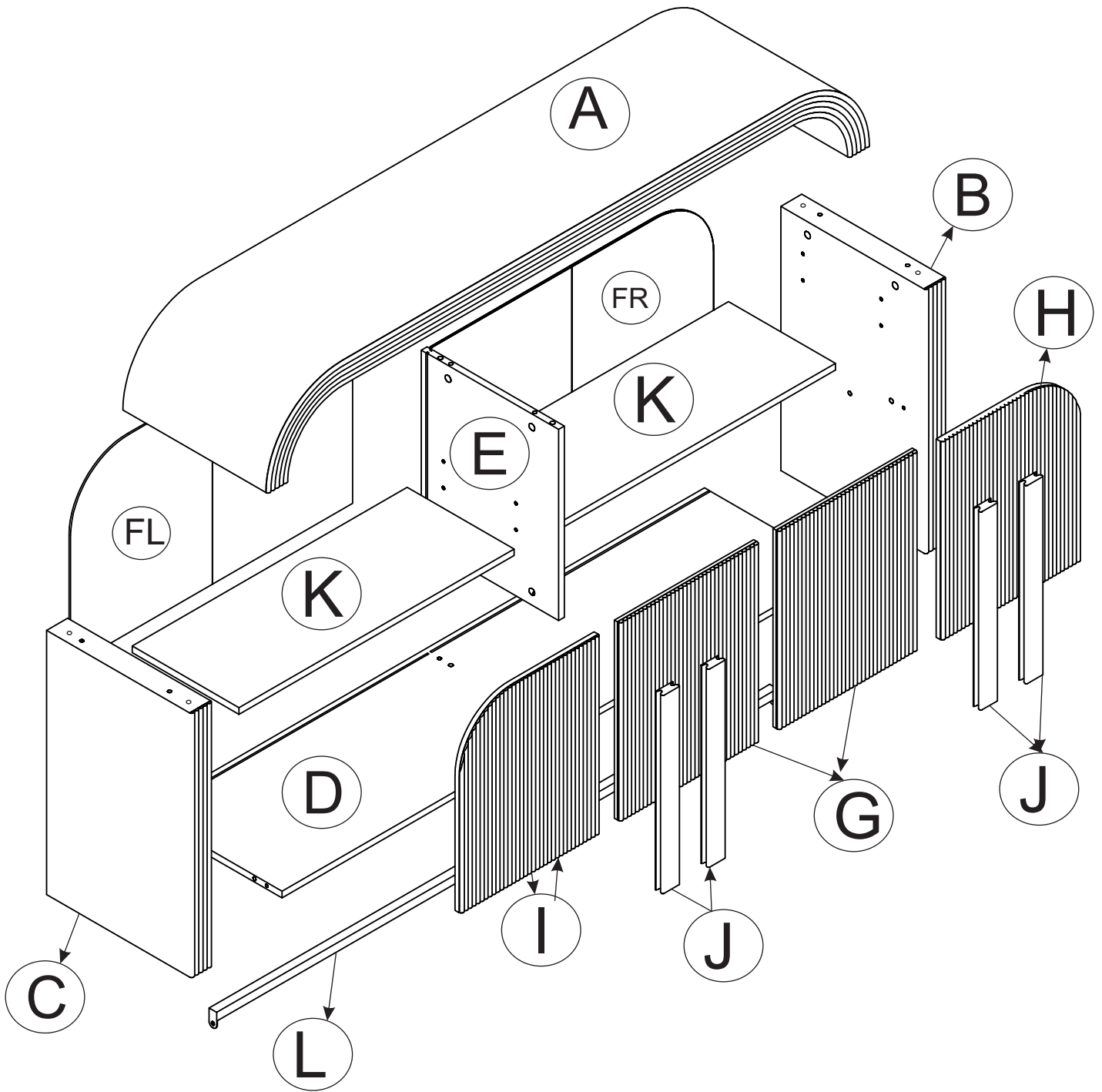

ASSEMBLY INSTRUCTION

ITEM NO. N711P415846

Part List

A

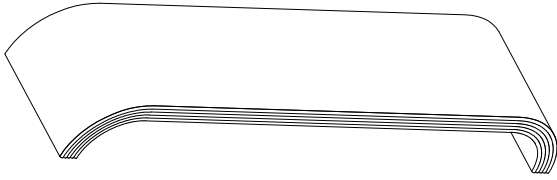

TOP (1 pc)

B

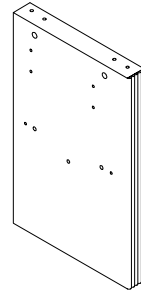

RIGHT SIDE PANEL (1 pc)

C

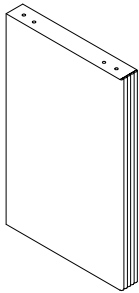

LEFT SIDE PANEL (1 pc)

D

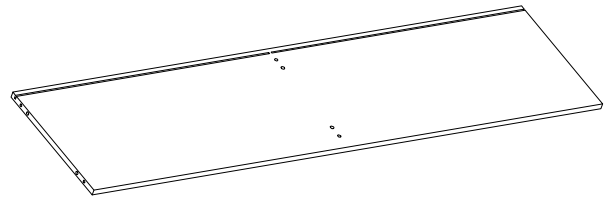

BOTTOM (1 pc)

E

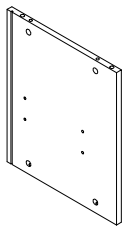

MIDDLE PANEL (1 pc)

FL

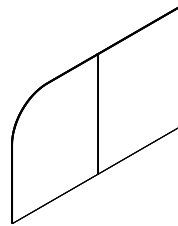

LEFT BACK PANEL (1 pc)

FR

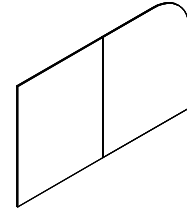

RIGHT BACK PANEL (1 pc)

G

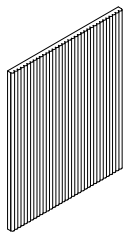

MIDDLE DOORS (2 pcs)

H

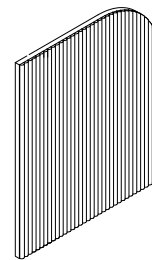

RIGHT DOORS (1 pc)

I

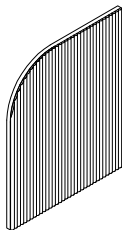

LEFT DOORS (1 pc)

J



HANDLE (4 pcs)

K

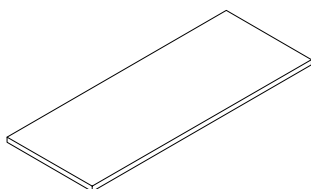

SHELF (2 pcs)

L









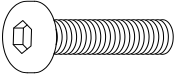
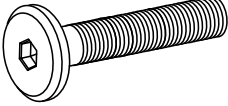

METAL SUPPORT (1 pc)

ASSEMBLY INSTRUCTION

ITEM NO. N711P415846

Hardware List

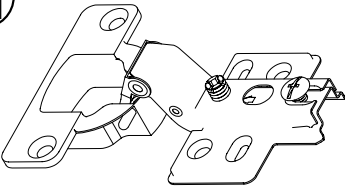
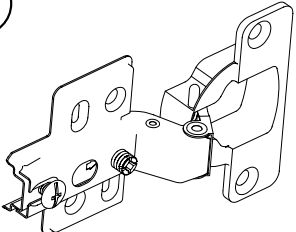
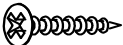
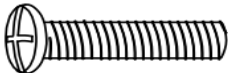
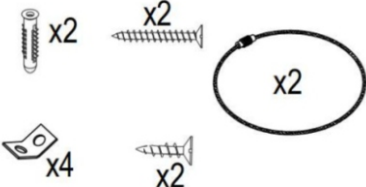
<p>①</p>  <p>Cam Bolt (10 pcs) $\varnothing 6 \times 28 \text{ mm}$</p>	<p>②</p>  <p>Cam Lock (10 pcs) $\varnothing 15 \times 12 \text{ mm}$</p>	<p>③</p>  <p>Wooden Dowel (12 pcs) $\varnothing 8 \times 30 \text{ mm}$</p>
<p>④</p>  <p>Short Bolt (2 pcs) $1/4" \times 20 \text{ mm}$</p>	<p>⑤</p>  <p>Long Bolt (2 pcs) $1/4" \times 38 \text{ mm}$</p>	<p>⑥</p>  <p>Spring Washer (4 pcs) $\varnothing 6 \times 12 \text{ mm}$</p>
<p>⑦</p>  <p>Flat Washer (4 pcs) $\varnothing 6 \times 12 \text{ mm}$</p>	<p>⑧</p>  <p>T Nut (2 pcs) $\varnothing 9 \times 12 \text{ mm}$</p>	<p>⑨</p>  <p>Allen Key (1 pc) K4 x 80mm</p>
<p>⑩</p>  <p>Patch Support Shelf (8 pcs) $\varnothing 6 \times 9 \text{ mm}$</p>	<p>⑪</p>  <p>Haft overlay Hinge (4 pcs)</p>	<p>⑫</p>  <p>Full overlay Hinge (4 pcs)</p>
<p>⑬</p>  <p>Flat Screw (48 pcs) 3×15</p>	<p>⑭</p>  <p>Bolt of Handle (12 pcs) M4 x 25</p>	<p>⑮</p>  <p>Antitip Kit (2 Sets)</p>

ASSEMBLY INSTRUCTION

ITEM NO. N711P415846

How to use cam locks

Did you know?

Cam locks are used to join two panels together, usually the edge of one to the flat side of another.

First, your cam bolt (or cam pin) will need to be properly inserted into the flat side of the board.

Important Note: Only tighten the cam bolt until it is secure. Do not over-tighten.

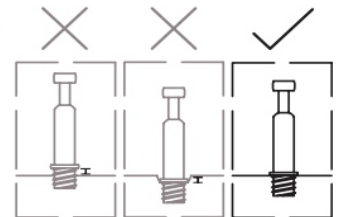
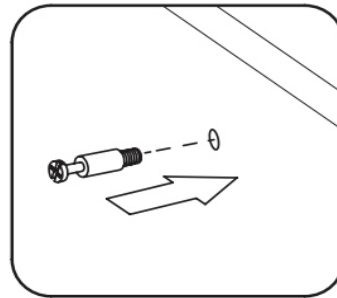

Next, you will fit the proper hole on the edge of the associated joining panel over the cam bolt.

Important Note: When installed properly, the head of the cam bolt will be visible through the larger hole on the side of the joining panel.

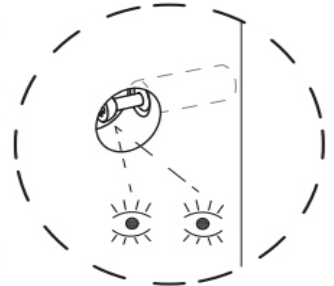
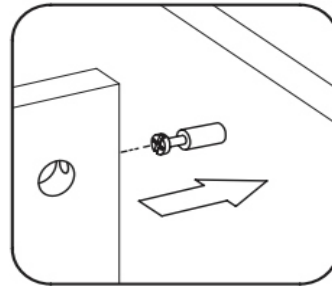

Next, you will notice the cam lock has a "C" shaped back. Commonly, an arrow on the front of the cam lock points in the same direction as the open section on back.

Using these as your cue, insert the cam lock into the large hole so the opening of the "C" fits over the head of the cam bolt.

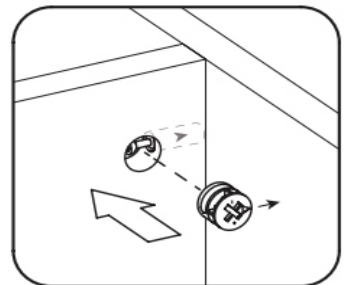
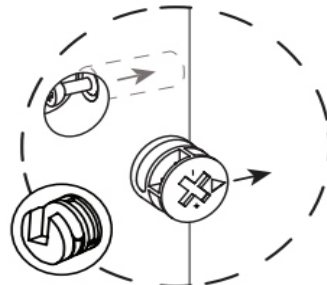

Using a screwdriver, you will turn the cam lock until it stops, usually between 130° or 180°. You will feel the panels pulling closer until they are secured.

Important Note: Only turn the cam lock until the panels are fully engaged & feel secure. Turning too far may lead to hardware failure.

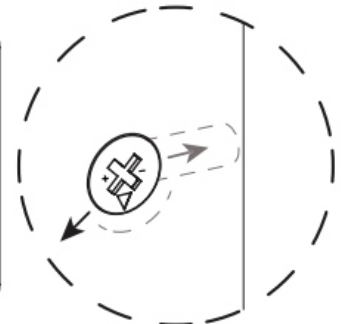
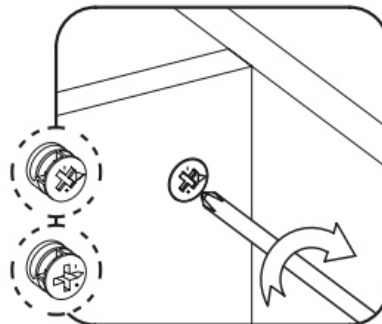

Still having issues?

If a cam lock seems to be spinning in place or is not "catching" or pulling the panels together as expected, first remove the cam lock & try again while making sure that everything is properly positioned & oriented.

If you are still having issues getting things working as expected, first remove the cam lock then unscrew the cam bolt slightly (less than 1 complete turn) to see if that helps with the alignment of the cam lock & bolt.

ASSEMBLY INSTRUCTION

ITEM NO. N711P415846

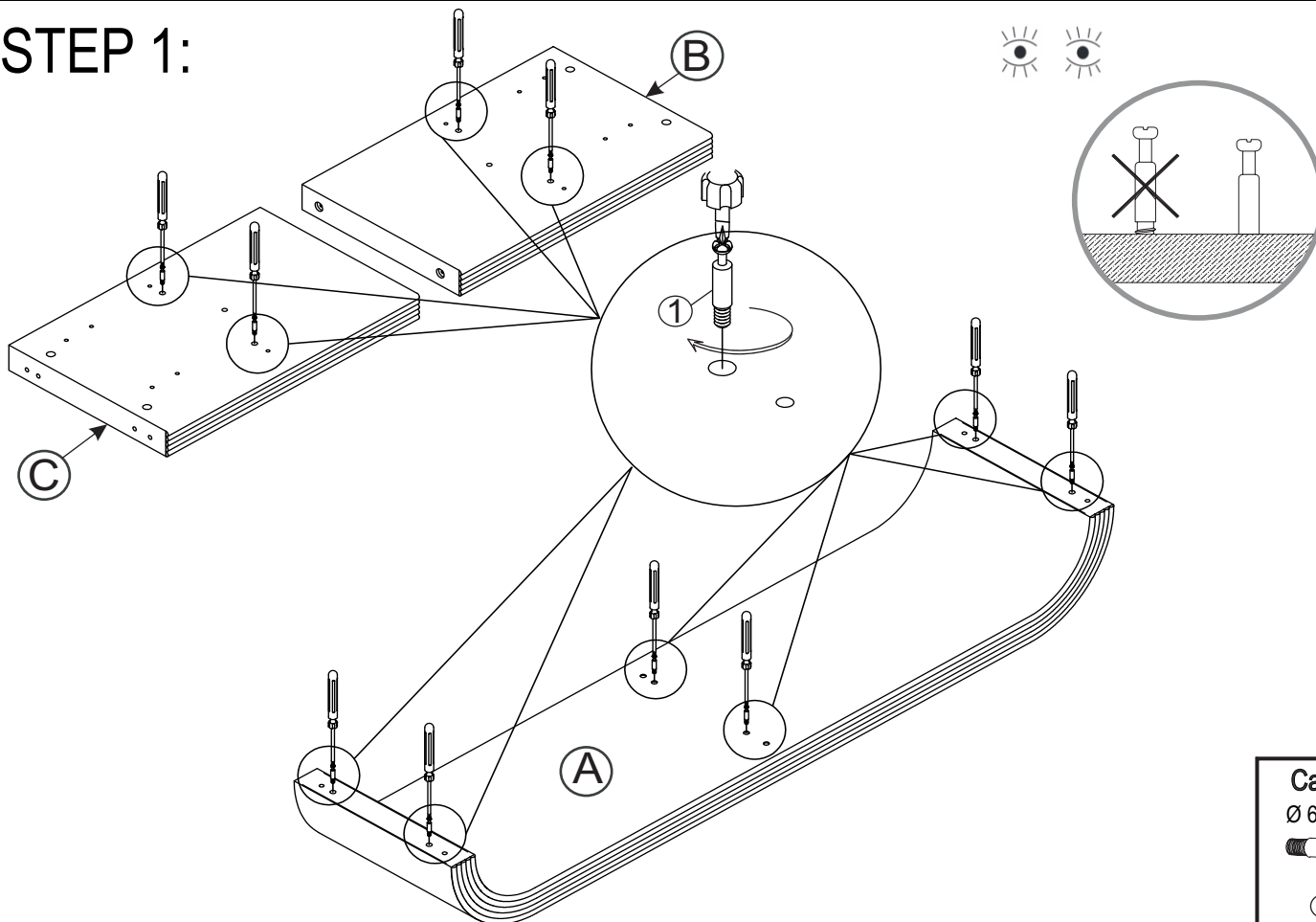

STEP 1:

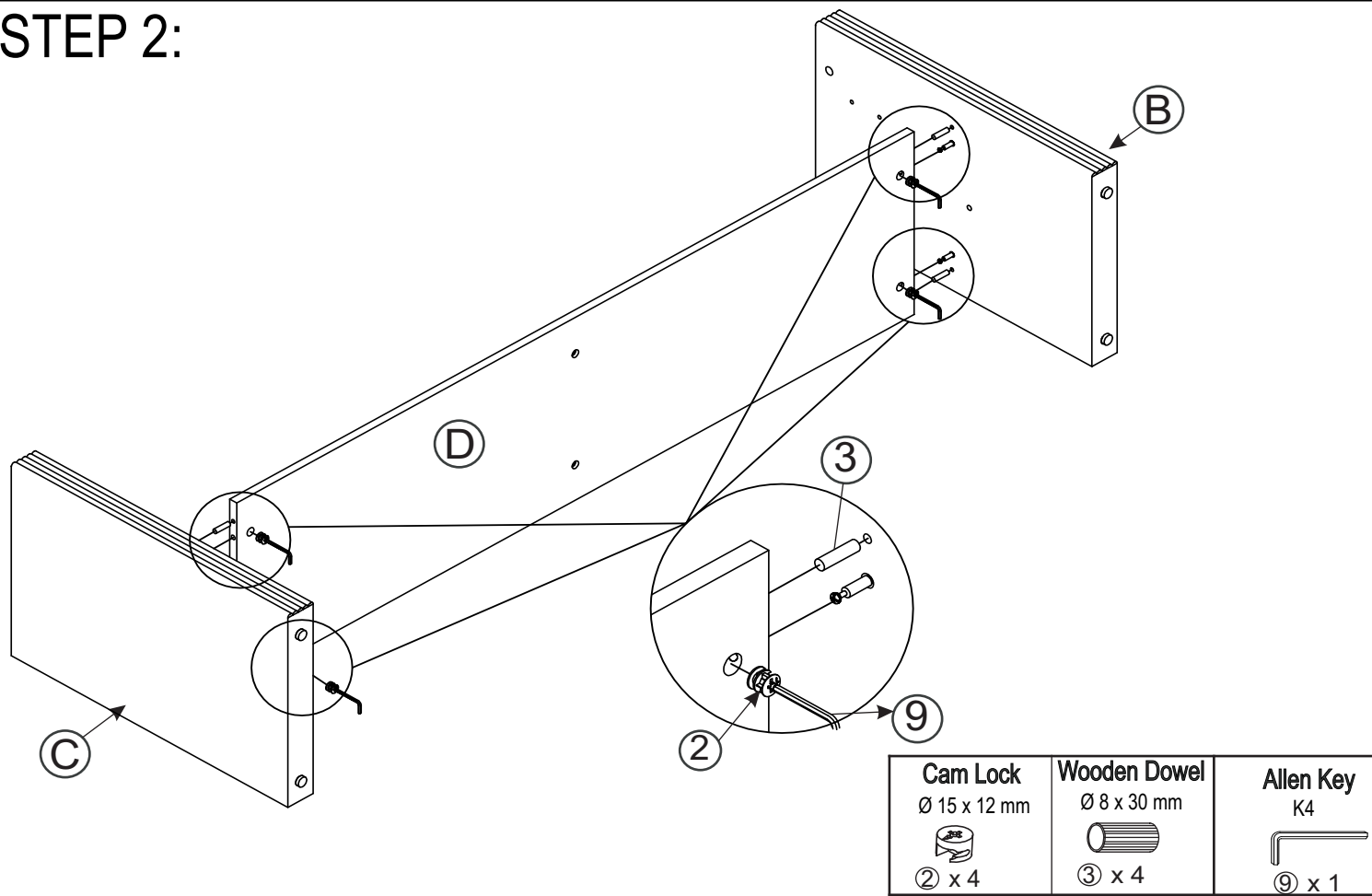

Cam Bolt
Ø 6 x 28 mm

① x 10

STEP 2:







Cam Lock Ø 15 x 12 mm  ② x 4	Wooden Dowel Ø 8 x 30 mm  ③ x 4	Allen Key K4  ⑨ x 1
---	--	--

ASSEMBLY INSTRUCTION

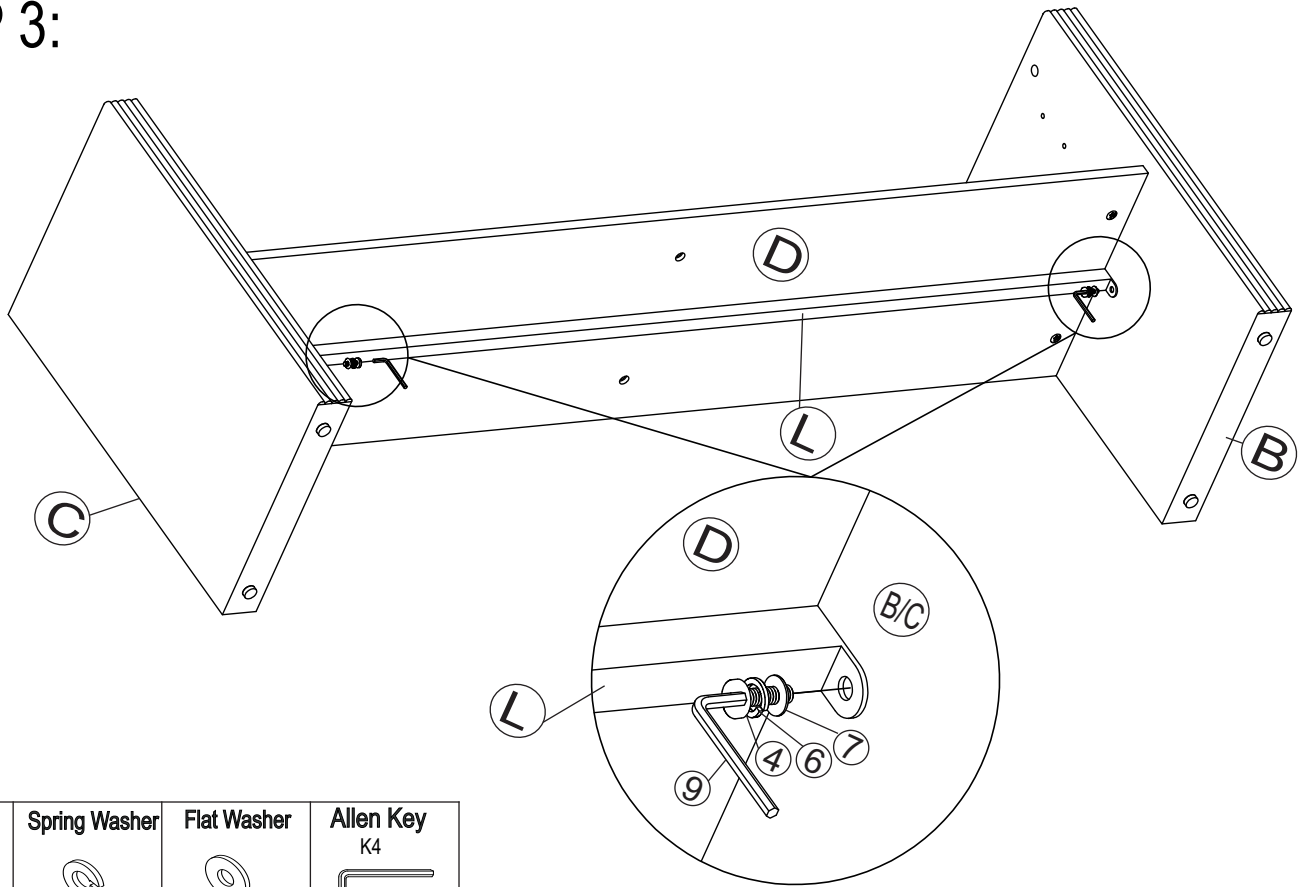
ITEM NO. N711P415846







STEP 3:

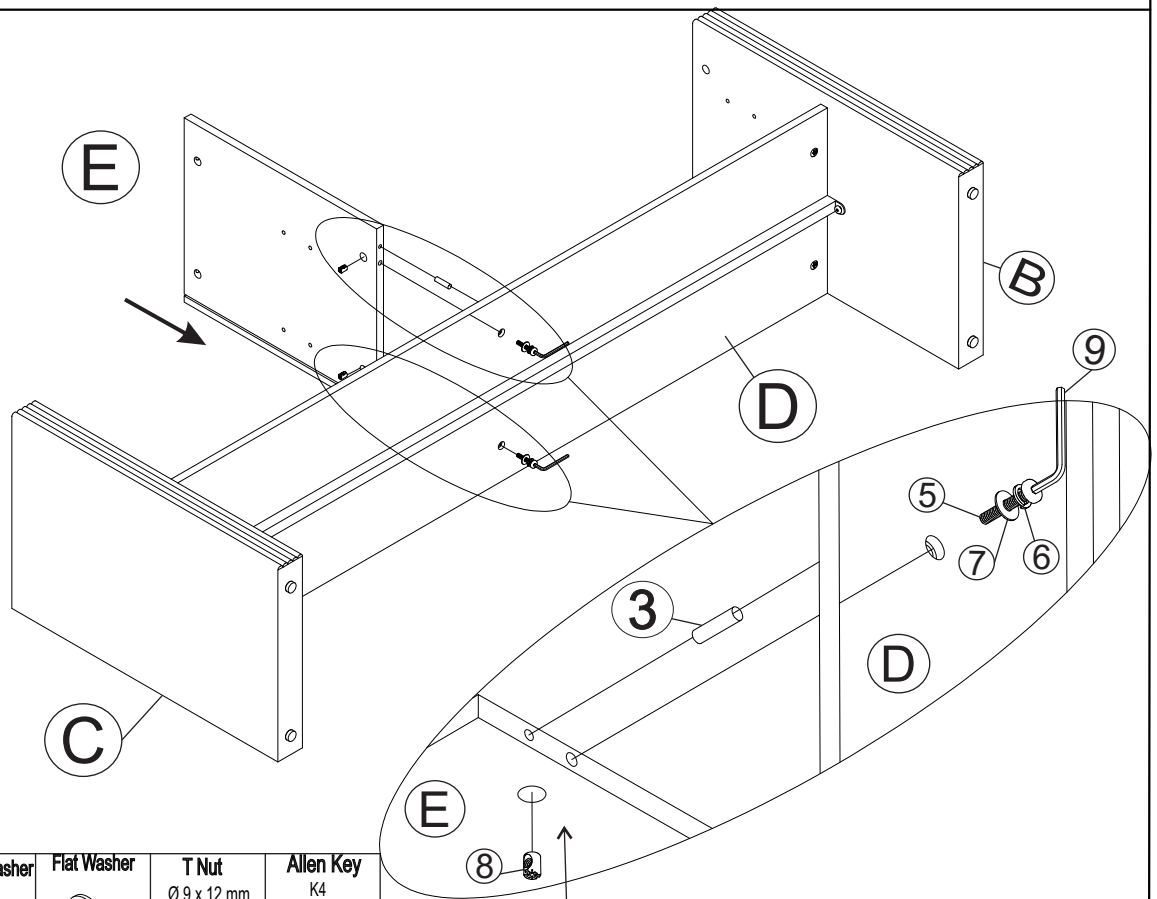

Short Bolt Ø 6 x 20 mm  ④ x 2	Spring Washer  ⑥ x 2	Flat Washer  ⑦ x 2	Allen Key K4  ⑨ x 1
--	--	--	--

STEP 4:



Wooden Dowel Ø 8 x 30 mm  ③ x 2	Long Bolt Ø 1/4" x 38 mm  ⑤ x 2	Spring Washer  ⑥ x 2	Flat Washer  ⑦ x 2	T Nut Ø 9 x 12 mm  ⑧ x 2	Allen Key K4  ⑨ x 1
---	--	--	--	---	--

ASSEMBLY INSTRUCTION

ITEM NO. N711P415846

STEP 5:

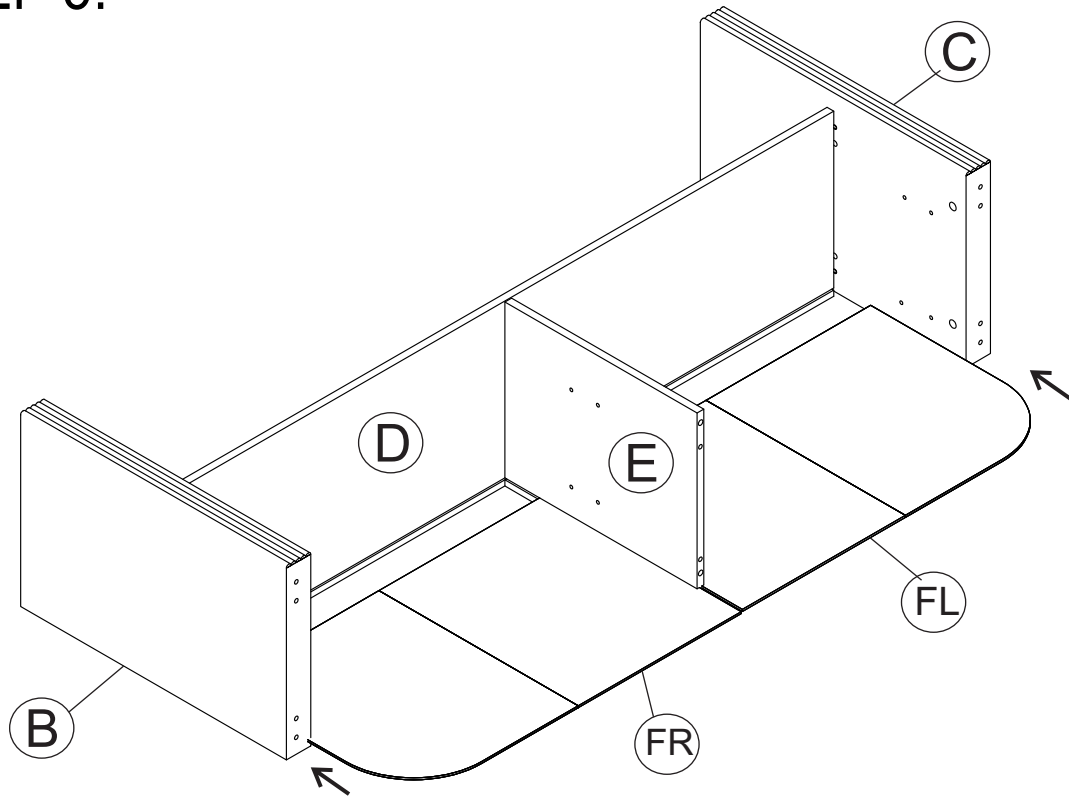

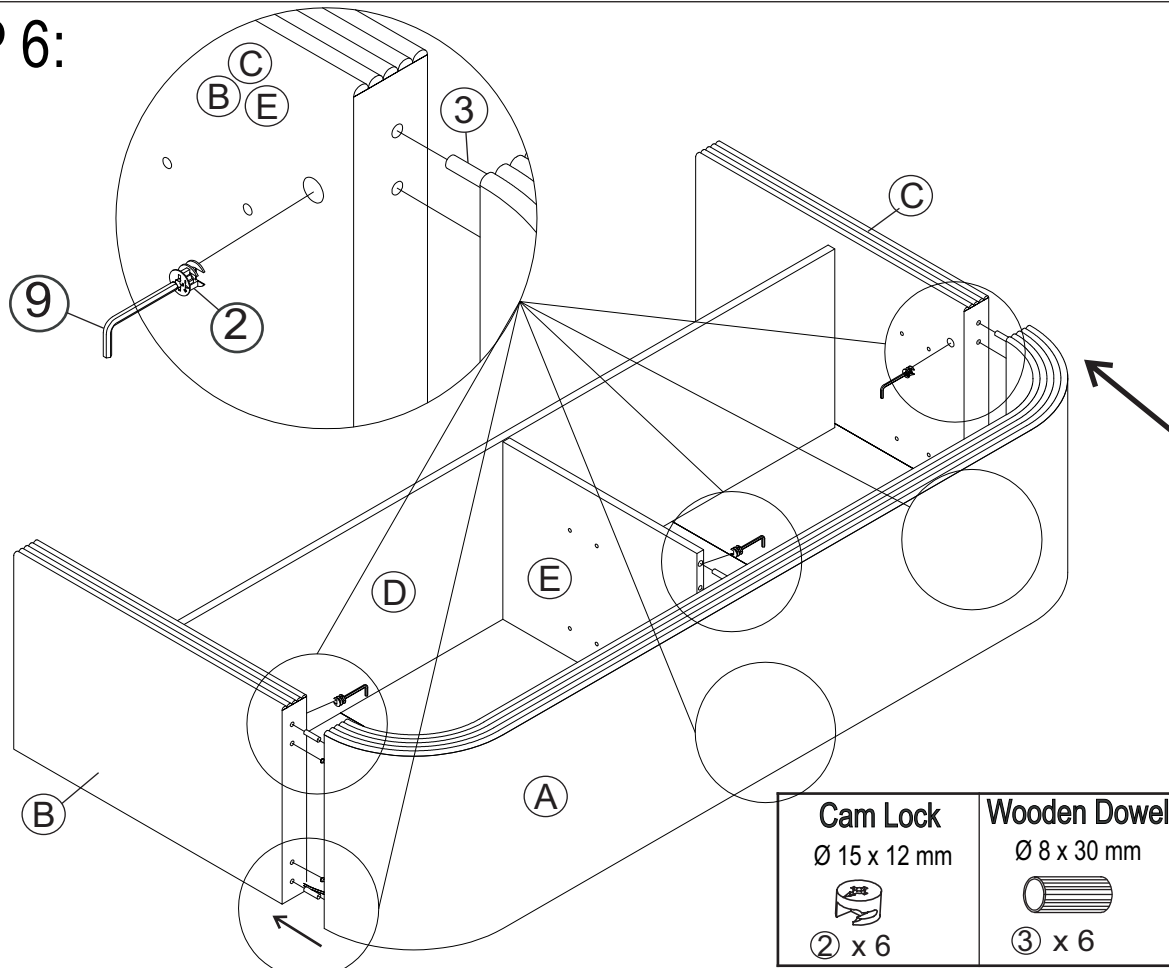

STEP 6:



ASSEMBLY INSTRUCTION

ITEM NO.N711P415846

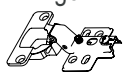
STEP 7:

Haft overlay Hinge  ⑪ x 4	Full overlay Hinge  ⑫ x 4	Flat screw Ø 3 x 15 mm  ⑬ x 16
---	--	--

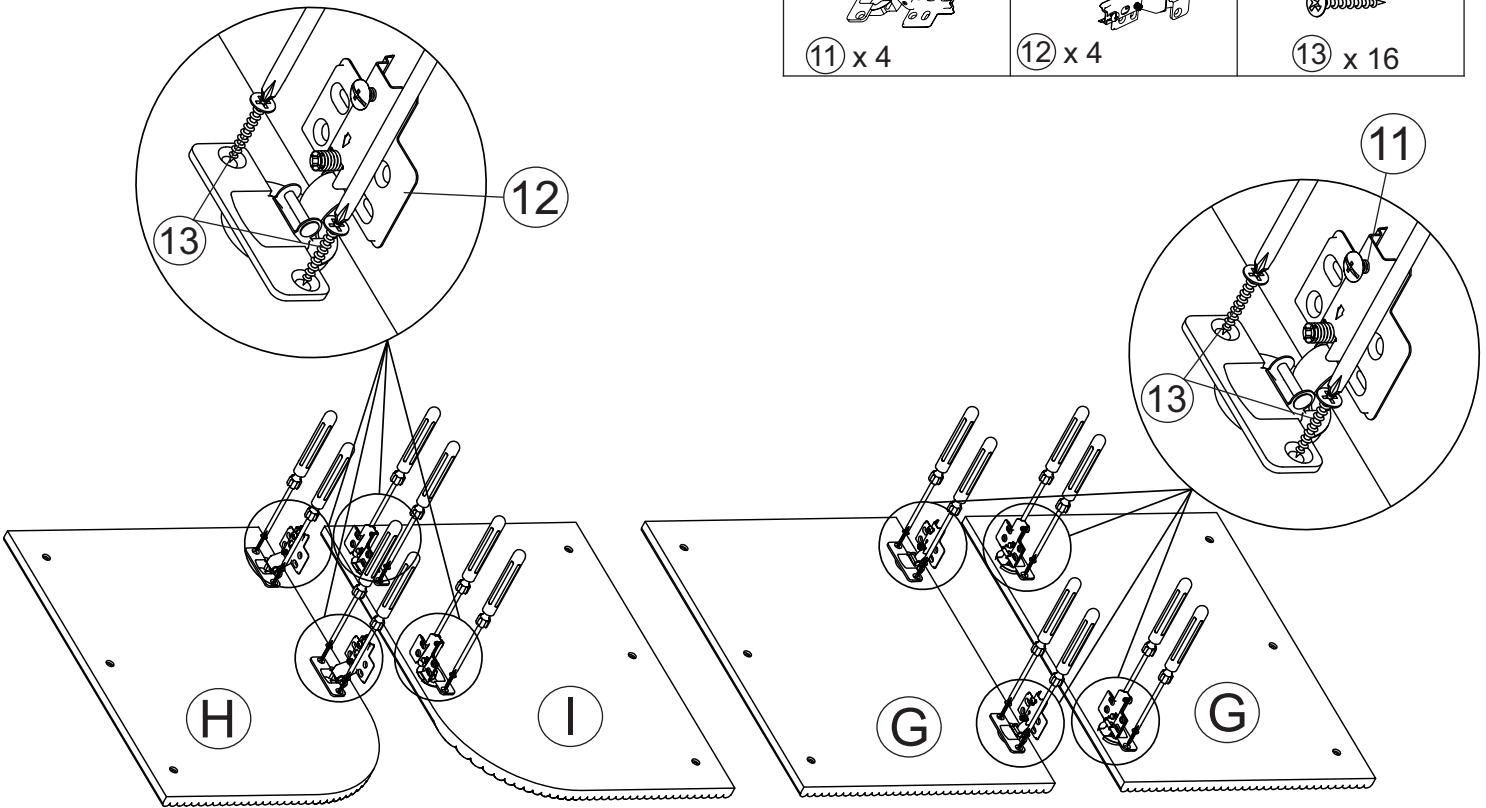

STEP 8:

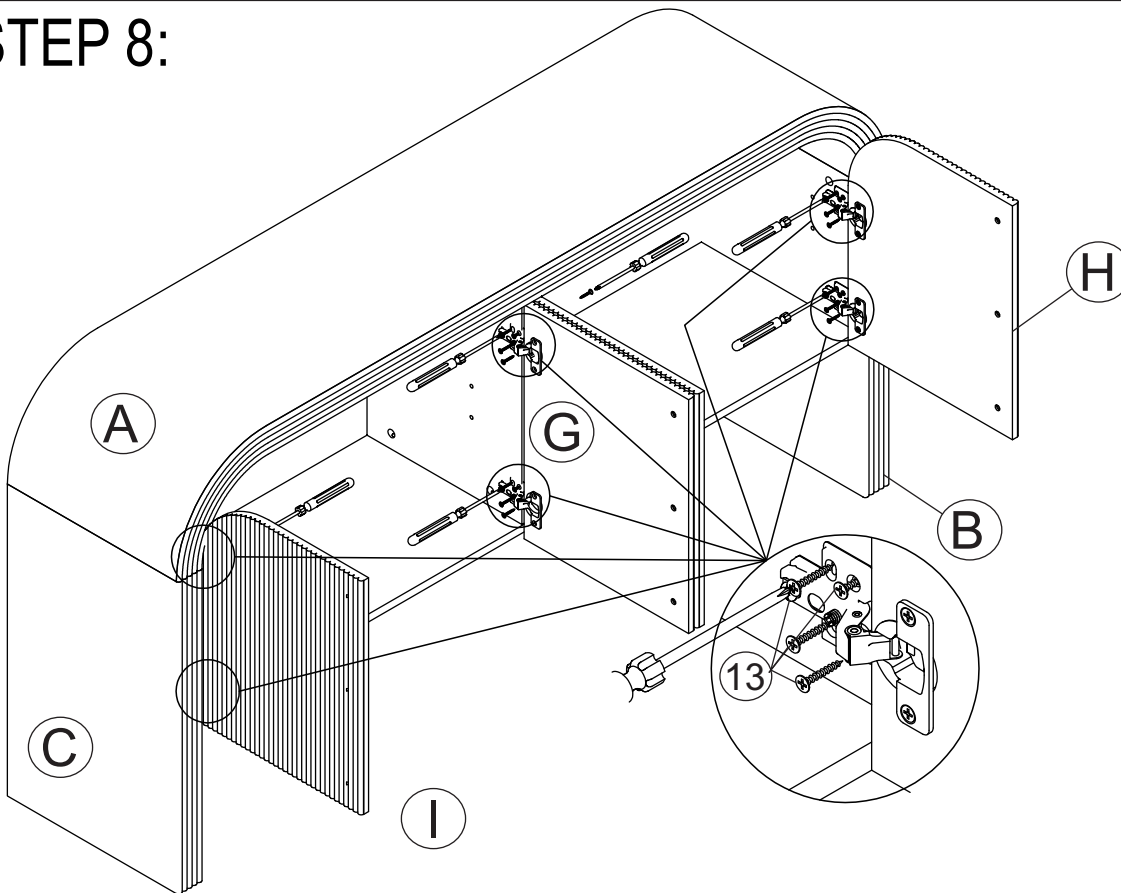

Flat screw Ø 3 x 15 mm  ⑬ x 32
--

ASSEMBLY INSTRUCTION

ITEM NO. N711P415846

STEP 9:

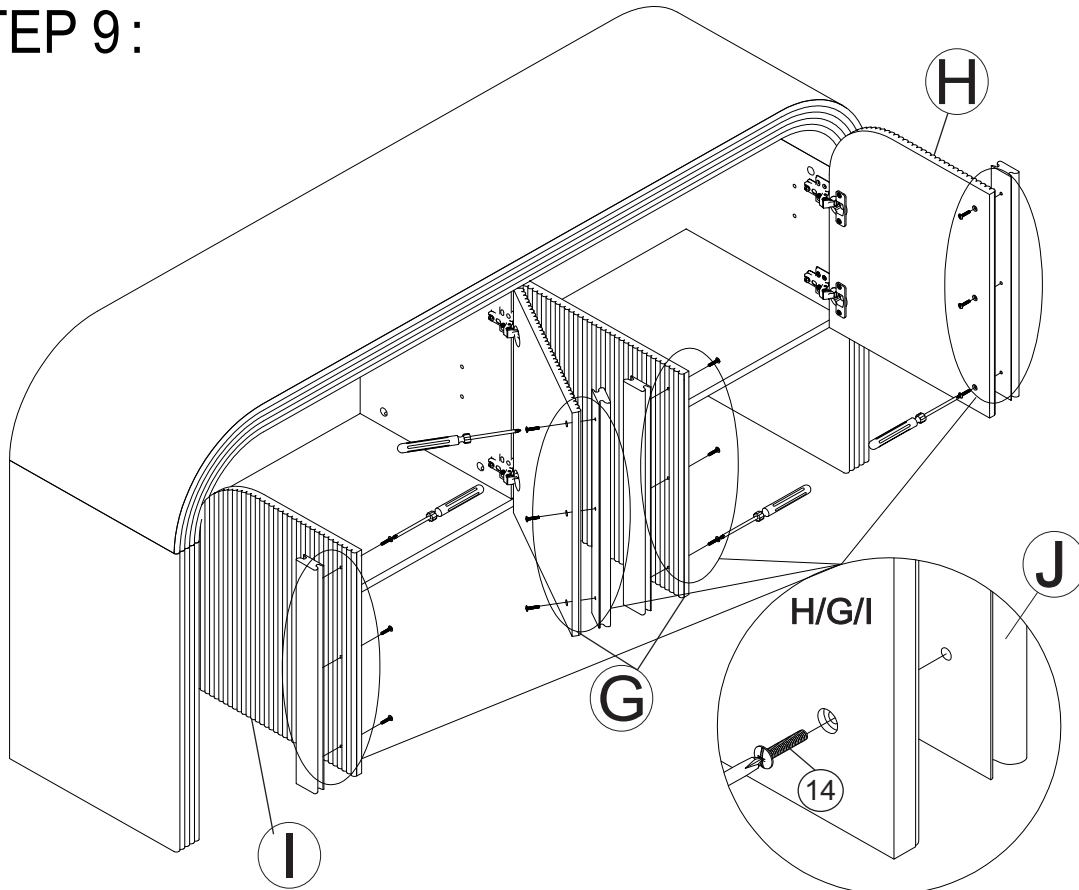

Bolt of Handle

Ø 4 x 25 mm

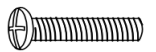

14 x 12

STEP 10

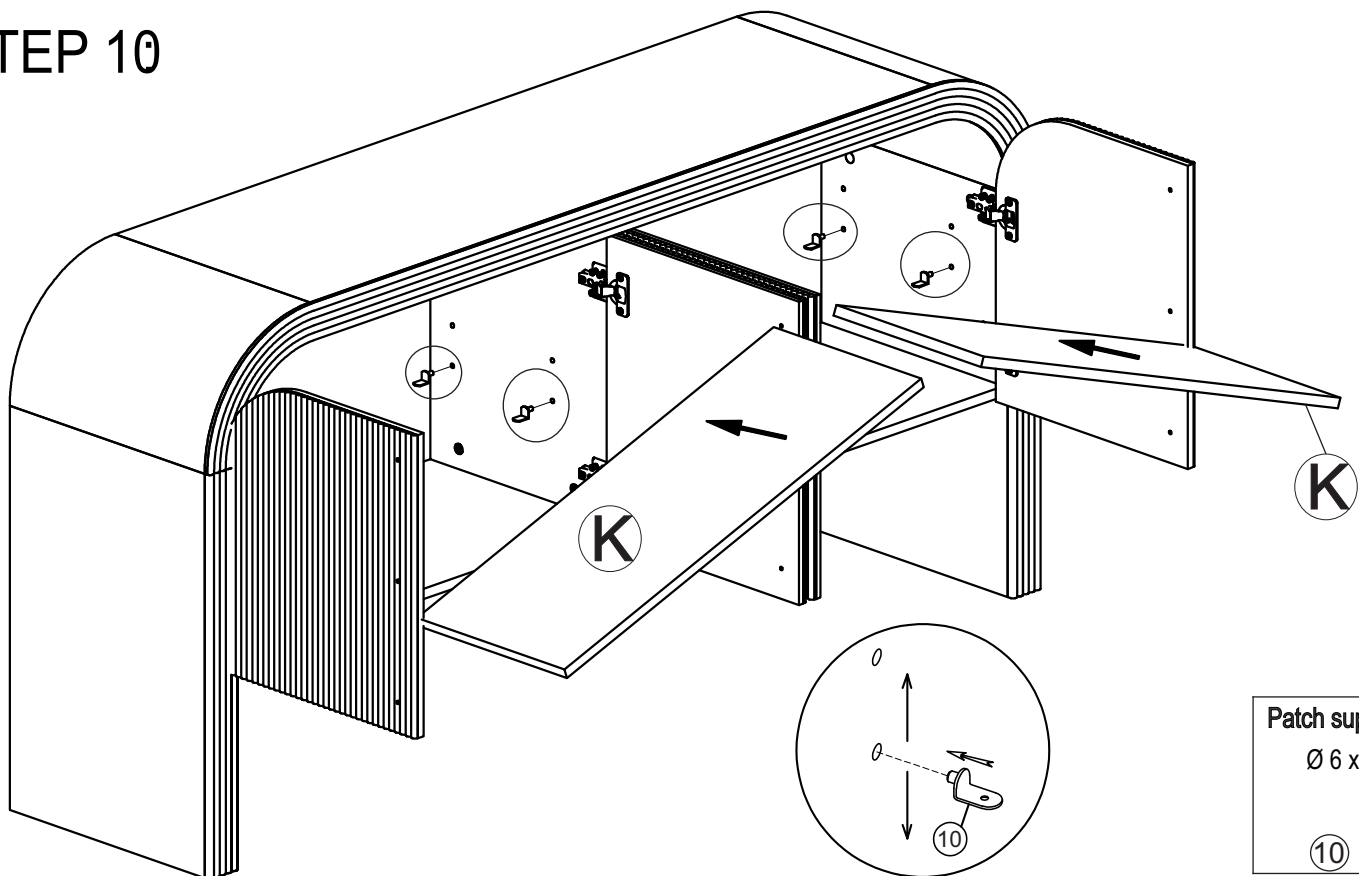

Patch support Shelf

Ø 6 x 9 mm



10 x 8



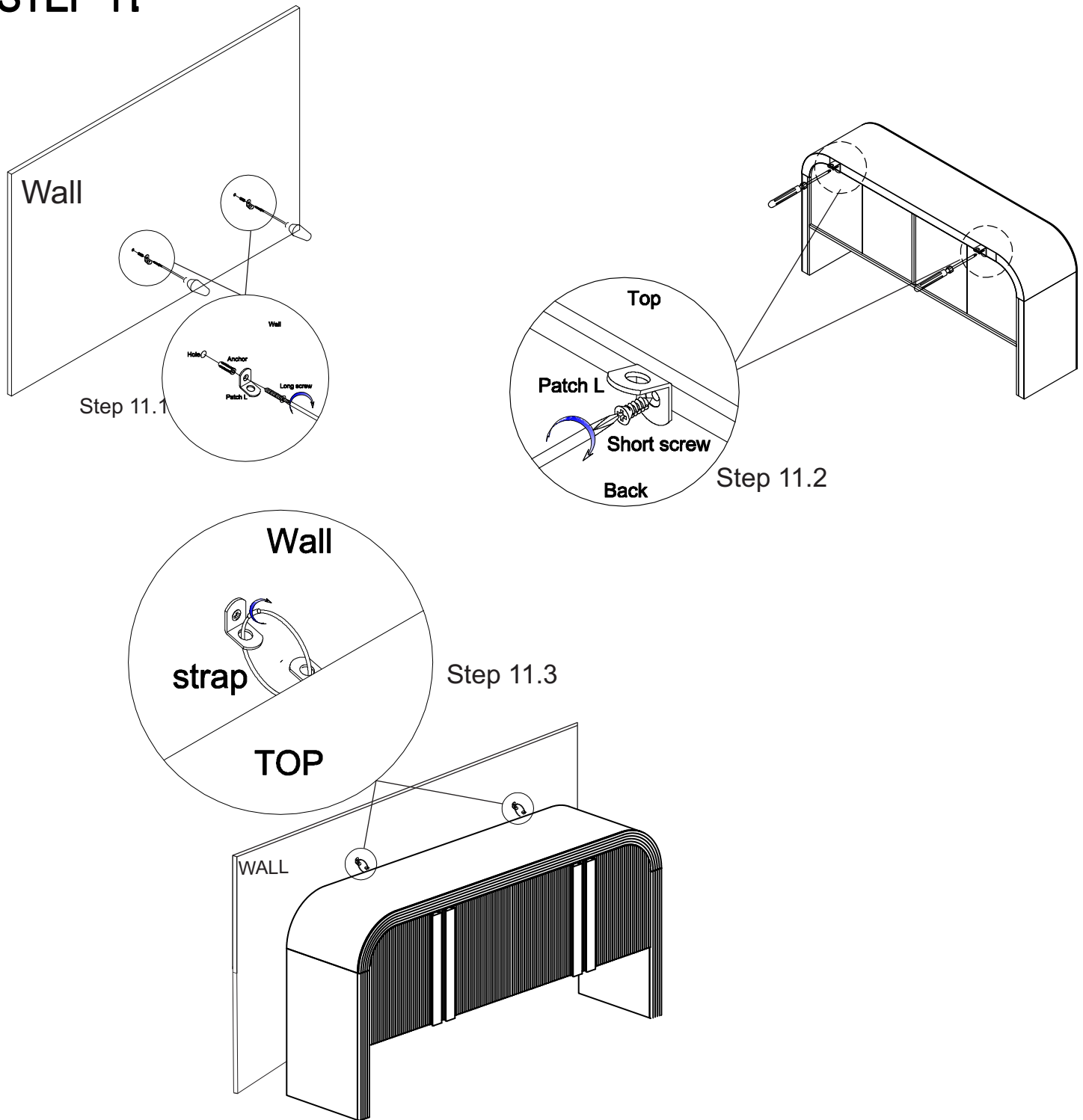

ASSEMBLY INSTRUCTION

ITEM NO.N711P415846

STEP 11

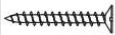

15 ANTITIP KIT =2SETS

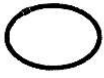
				
2 pcs	4 pcs	2 pcs	2 pcs	2 pcs

ASSEMBLY INSTRUCTION

ITEM NO. **N711P415846**

Is your cabinet door looking crooked or unevenly spaced?

If you're still having trouble lining everything up, your next step should be to try to adjust the feet slightly to square up the cabinet and doors. Follow the instructions below:

If the right door appears to be hanging low, you can adjust the adjustable leveler on the front right until the door is better aligned.

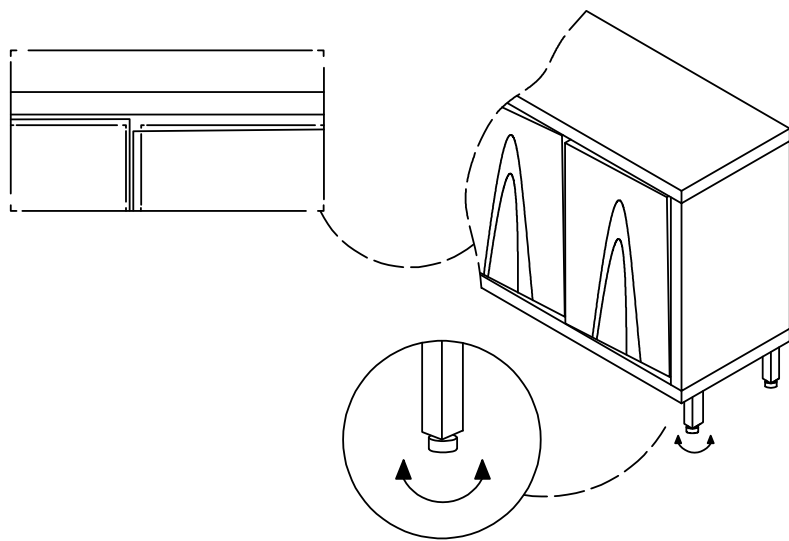

If the left door appears to be hanging low, you can adjust the adjustable leveler on the front left until the door is better aligned.

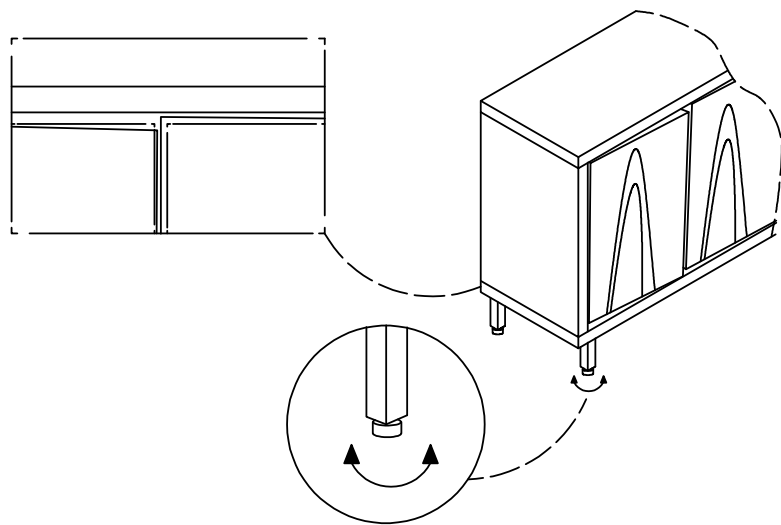

ASSEMBLY INSTRUCTION

ITEM NO. **N711P415846**

Is your cabinet door looking crooked or unevenly spaced?

Then you've come to the right place. Follow the illustrations below to get your cabinet door aligned and ready for action,

If your door is too low or too high...

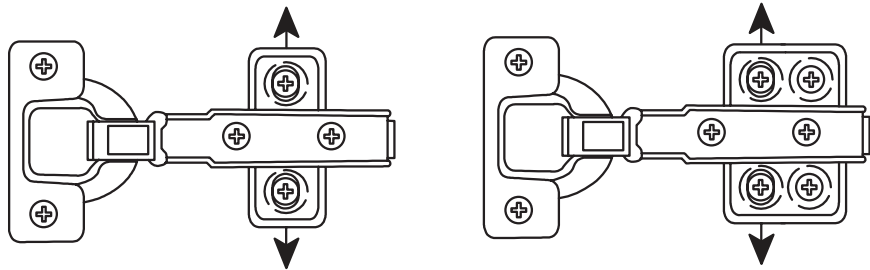
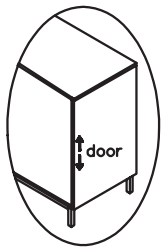

Loosen the height screws, then move the door up or down to make it level.

If the space between your doors is off...

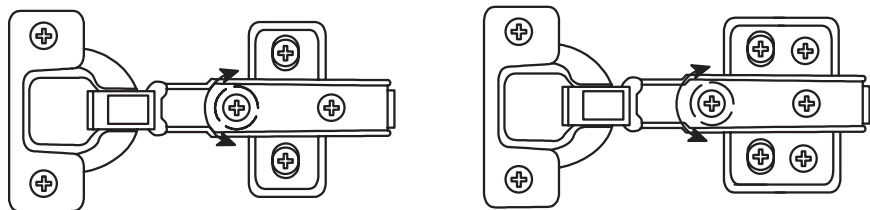
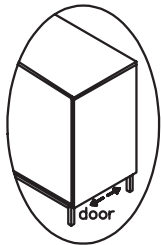

Loosen the side-to-side screws, then screw counter-clockwise to make the gap wider or clockwise to close any gaps.

If you need to adjust the depth of the doors...

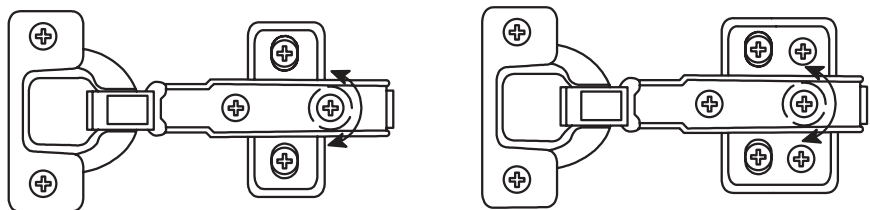

Adjust the in-and-out screws until the door is aligned with the side of the cabinet.