

Assembly Instruction

SKU:WF310342

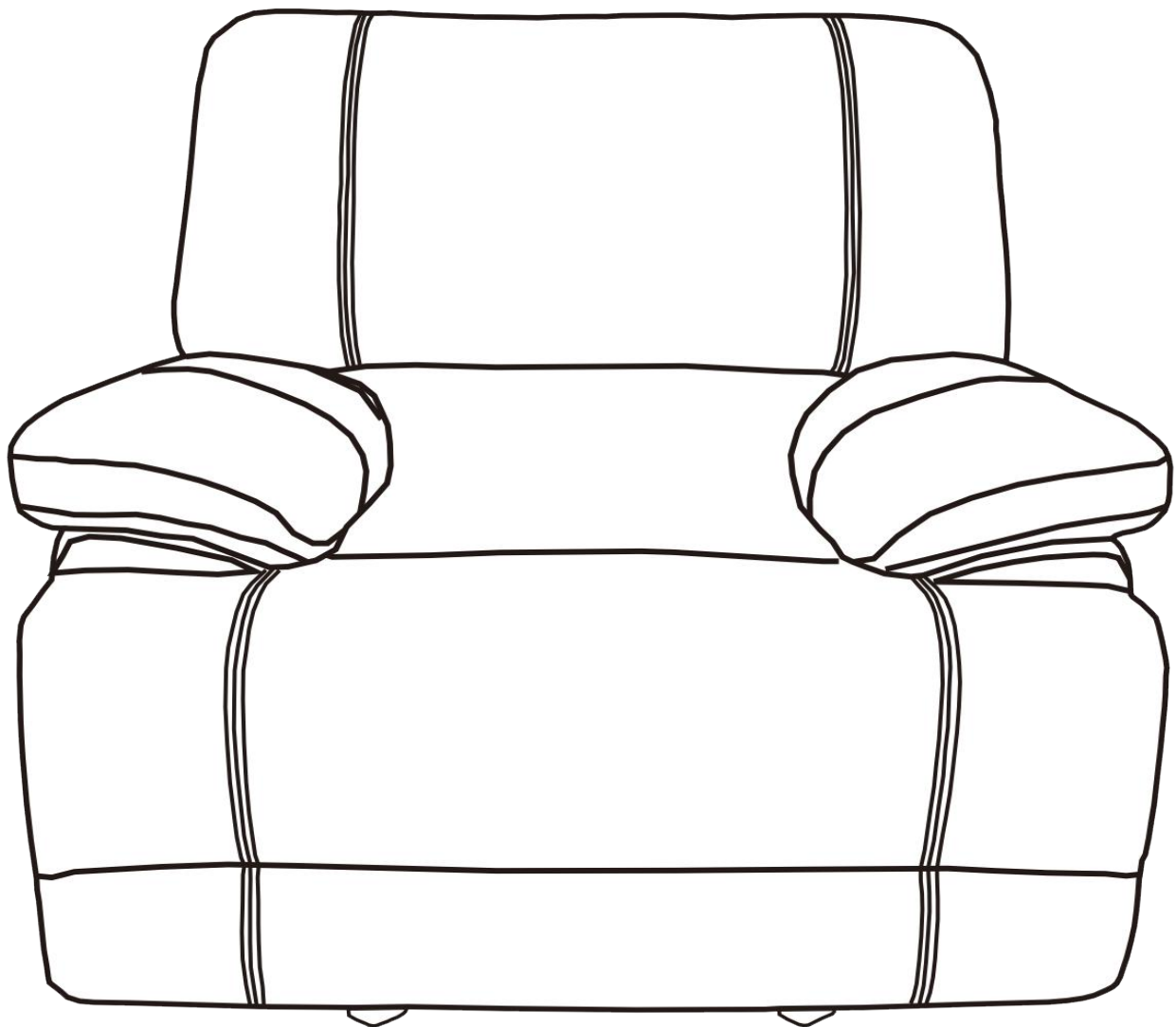

PARTS

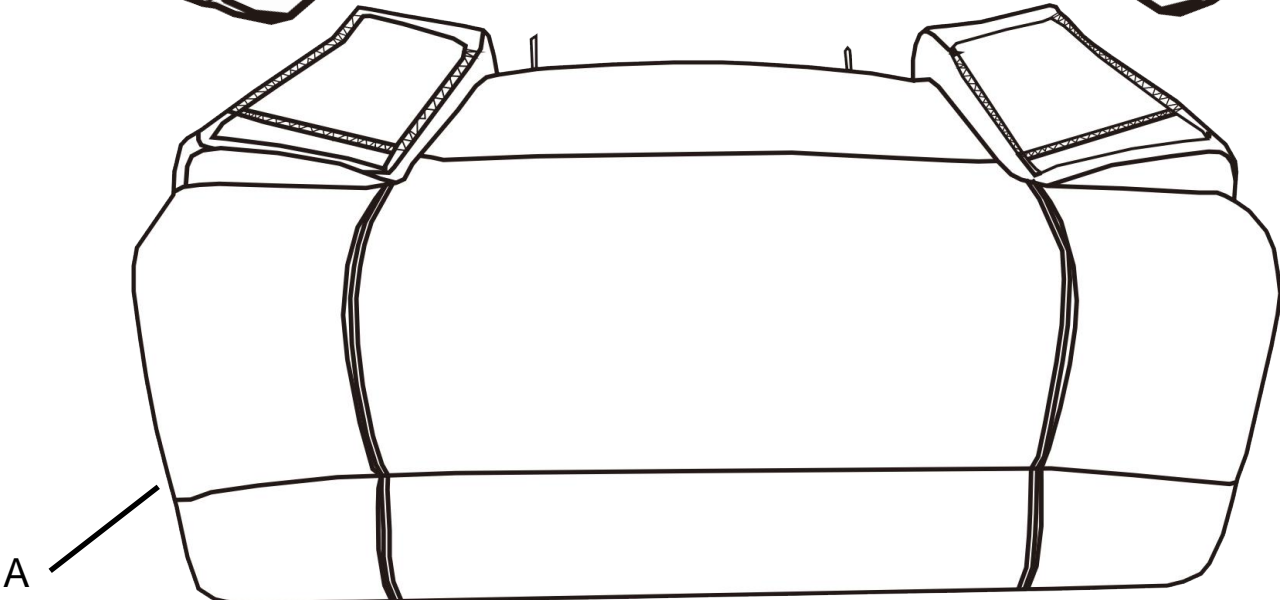
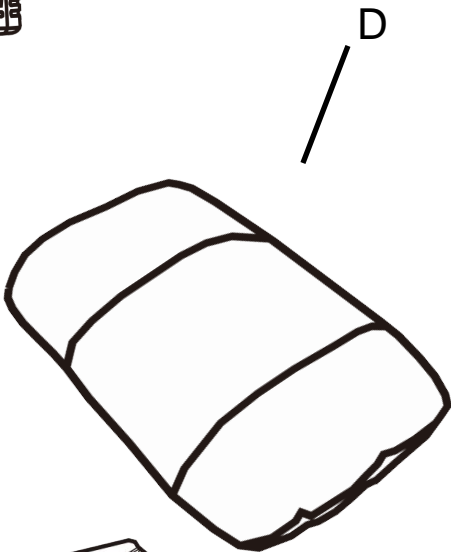
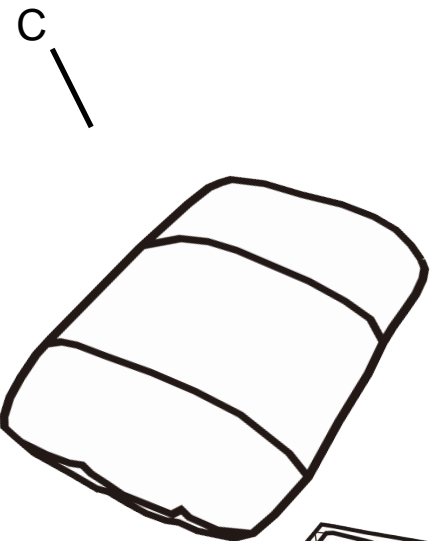
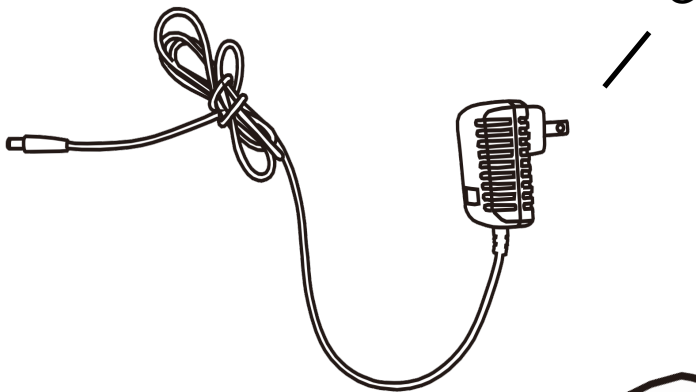
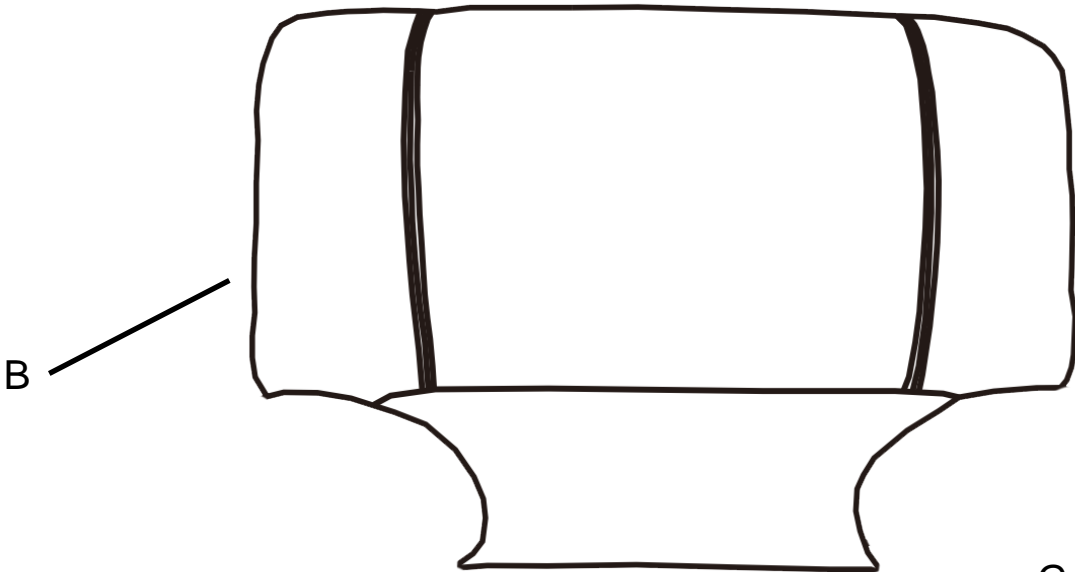

Step 1:

Cut the zip ties on the frame at the bottom of the seat with scissors.

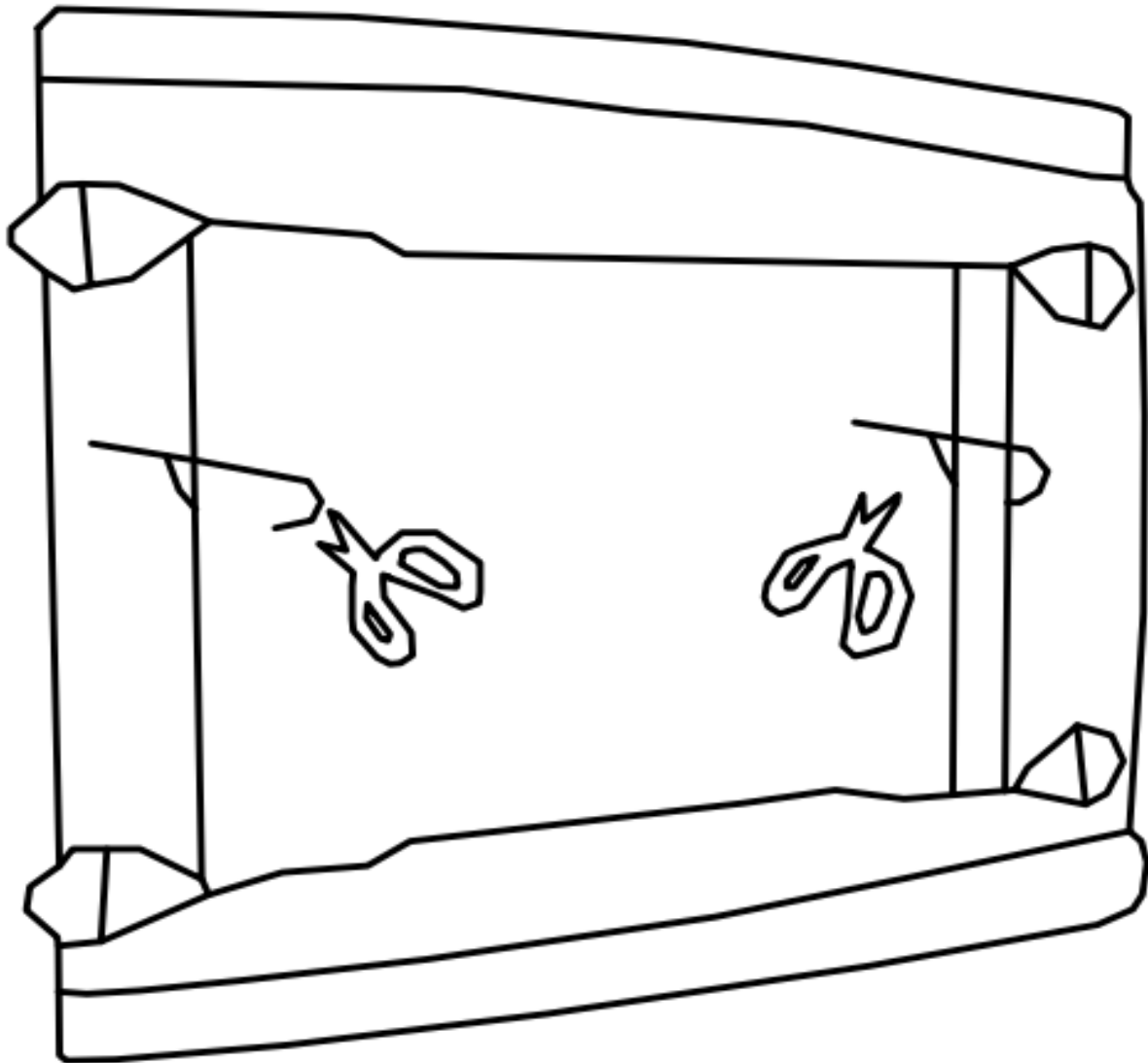

STEP 2:

Insert the insertion tube into the bottom of the socket cavity, insert it to the bottom, and then pull the pull head.

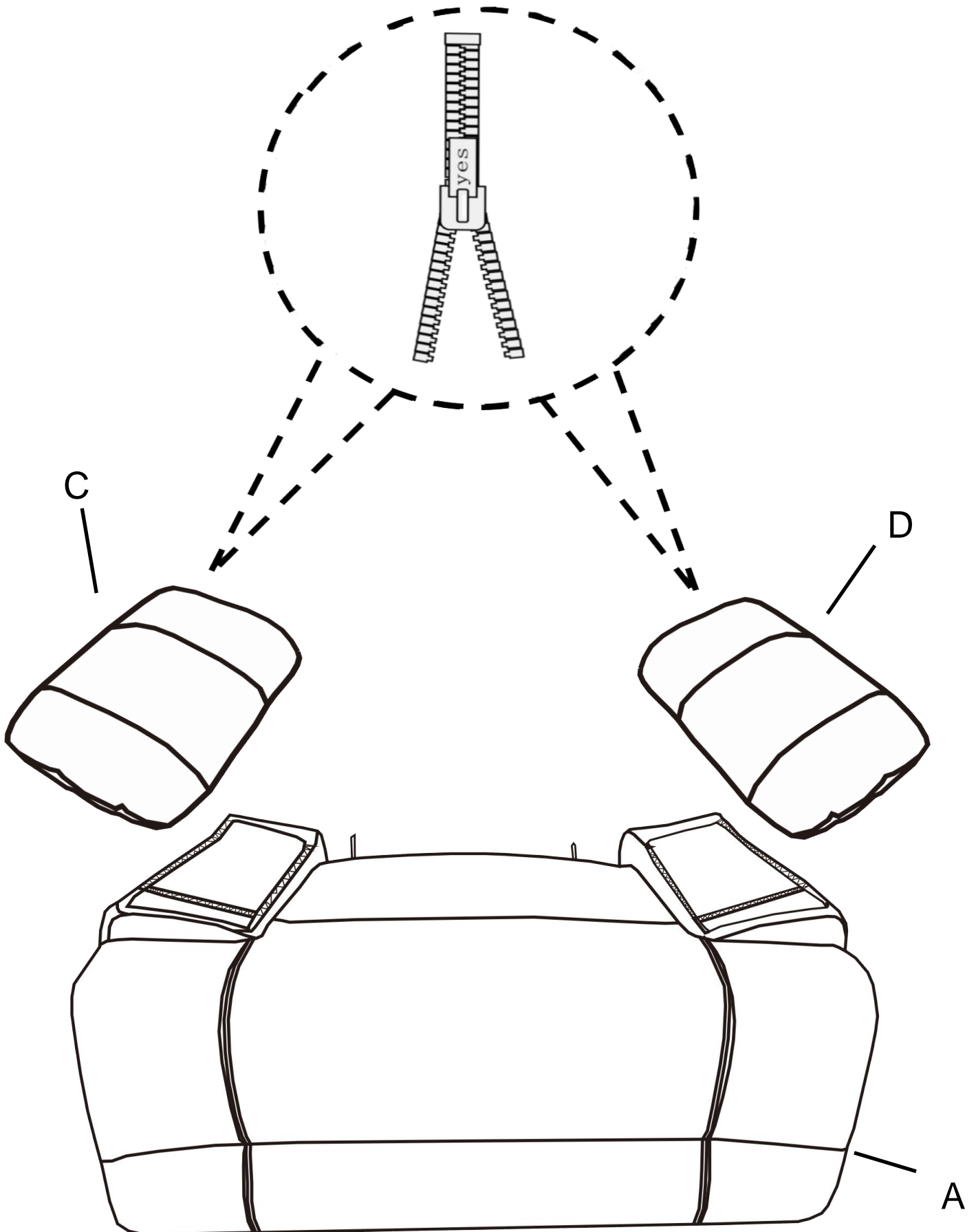

STEP3:

Install the backrest (B) by align and insert the metal bracket on the backrest (B) to the metal bracket of the seat (A). Please make sure the brackets are inserted all the way and secured into position.

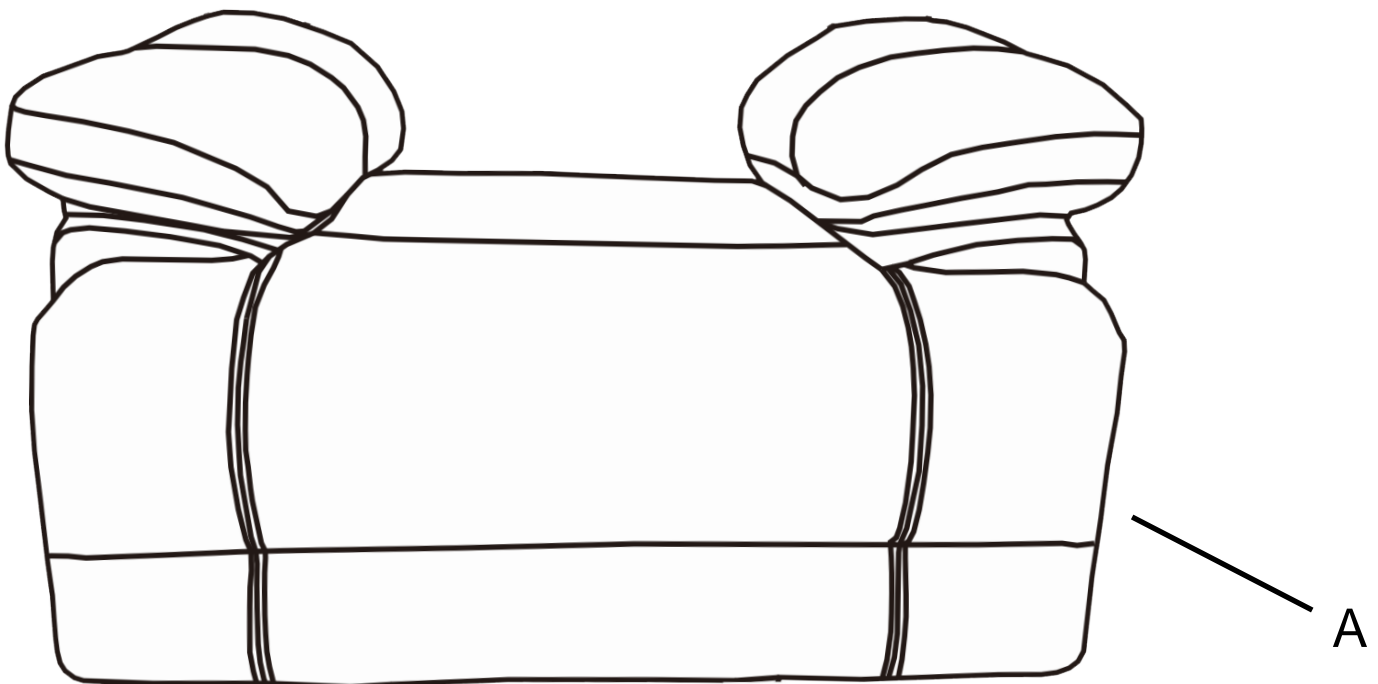
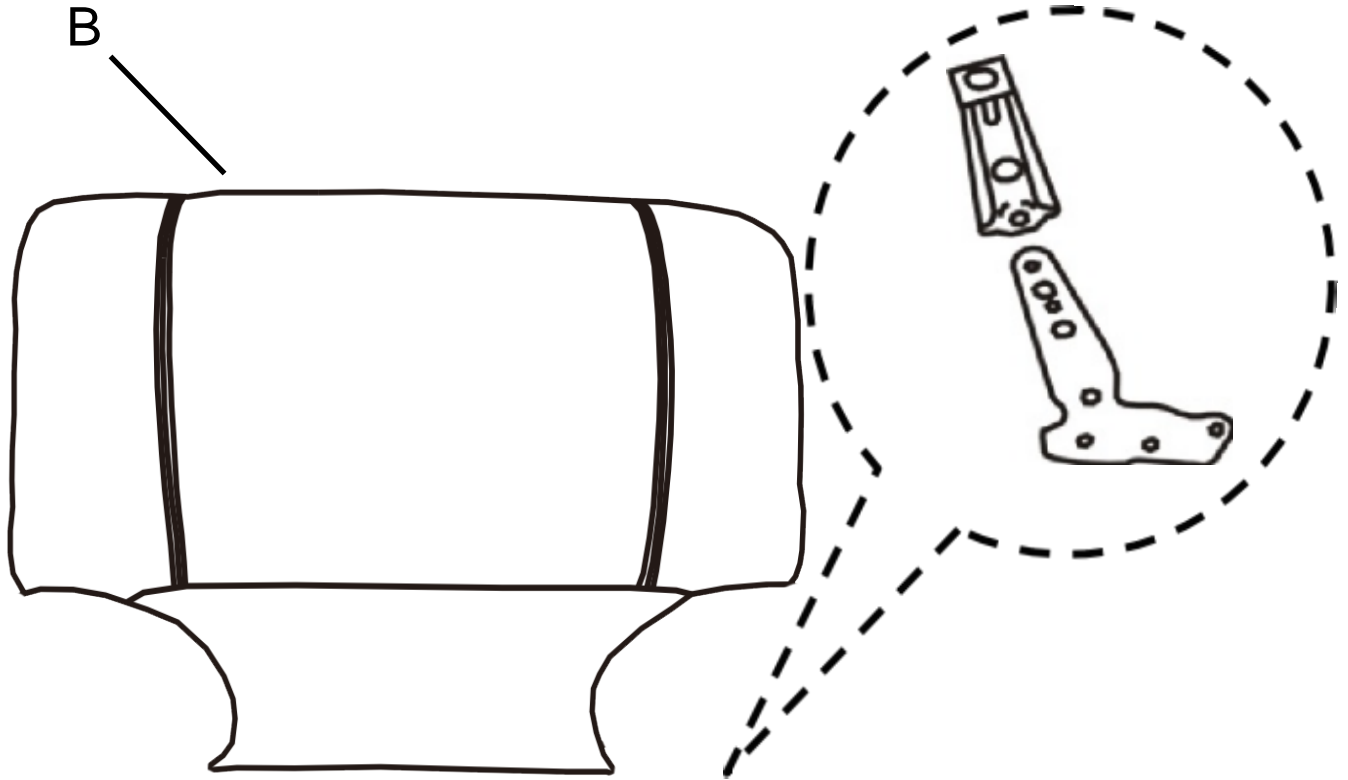

STEP 4:

Power Connection

Attach the power cord located at the bottom rear of the seat to the power plug (G), then open the light tape switch and the LED light will illuminate.

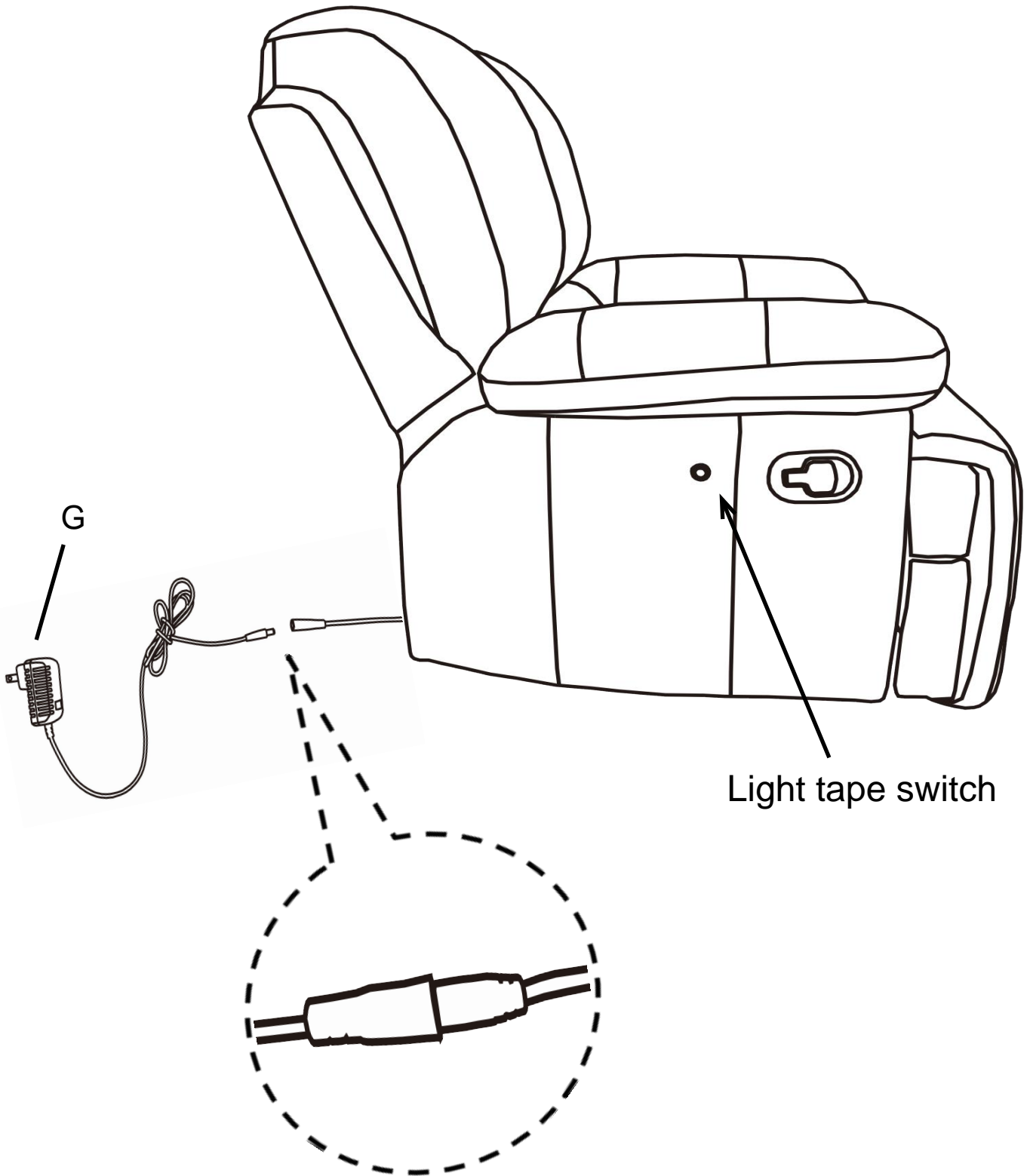

STEP 5:

Your product will look similar to this when assembly is complete.

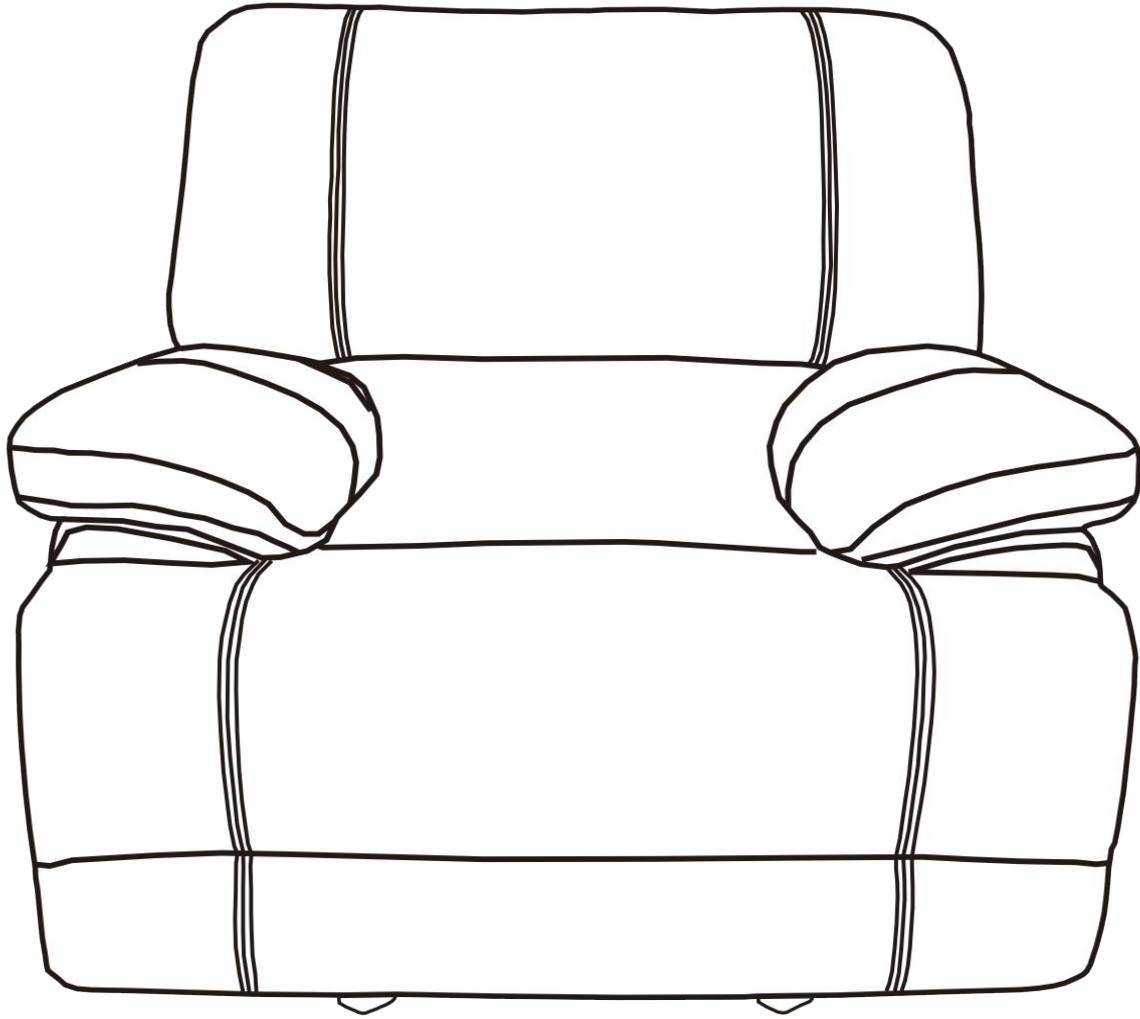

Helpful Hints

- Move your new furniture carefully with two people lifting and carrying the unit to its new location.
- Your furniture can be disassembled and reassembled to move.
- Clean the product with a soft damp cloth. **DO NOT** use harsh chemicals or abrasive cleaners.