

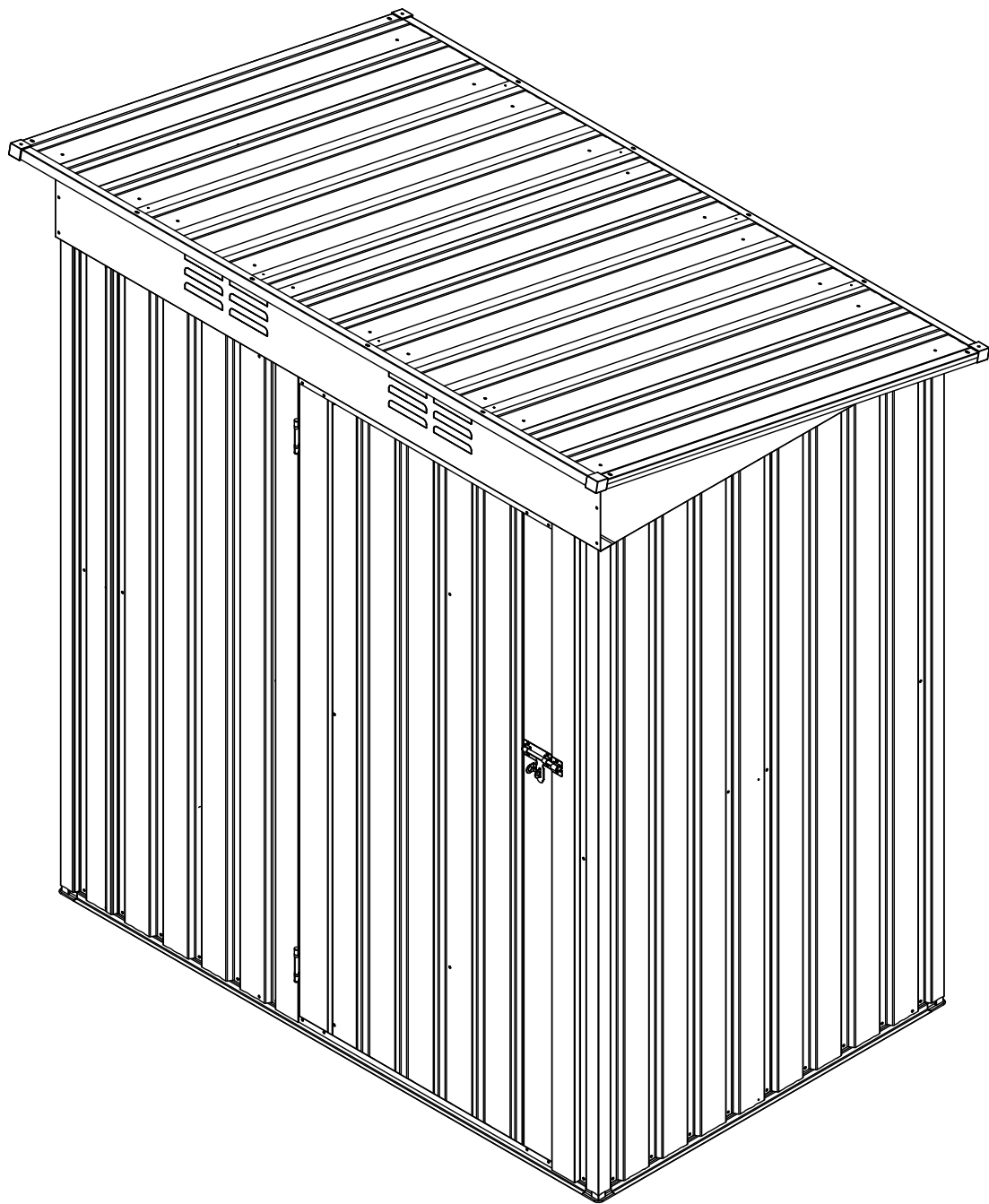

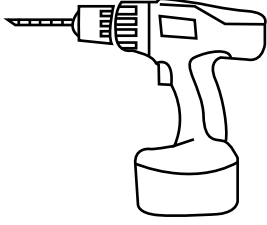

5*3 Storage Shed Installation_ITR-DG

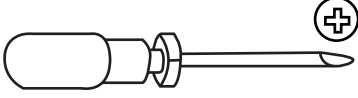

Please prepare below tools before installation.

 Electric Screwdriver	 Ladder	Not Included
Package included Tools  + Manual Screwdriver	 Gloves x 2 Pair	 Screwdriver x 1

ATTENTION:

Please read this instruction carefully before installation and follow it strictly during installation. Ensure that there are no problems later due to installation errors.

Installation Notes

Please check the quantity of all parts before installation (Please refer to the Parts Lists) and the appearance of the products. Please make sure the product is correct before installation. If there is any problem, please contact us directly.

Make sure the colored panels are facing outwards and all the holes match. The panels are textured, please install the panels in the order specified in the instructions. All lines and holes must be accurately matched to make the storage shed more stable. Please ensure that all screws are tightened to prevent the product from falling apart.

There is a protective film on the surface to protect the product, please tear it off after installation to get the final presentation. If you do not damage the film during installation, it can also remain on the product to protect the product.

Please place the product on a flat ground to prevent leaning and collapse. If the ground is uneven, the door may can't be closed.

Safety Precautions











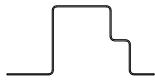

We recommend two adults to complete the installation. Two adults installed together will make the installation process easier and safer.







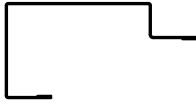



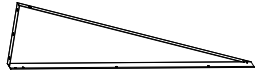

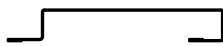
The gloves must be carried to prevent hand cuts during installation.

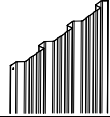
Take care when using power tools near water the use of a residual current device(RCD) is advised. Please use the electric driver carefully during screwing to prevent the screw from slipping and hurting your hand.(We recommend that beginners use a manual screwdriver for installation.)

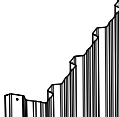
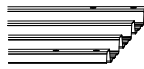
Be careful not to fall when installing the roof. Please steady the ladder and make sure the product placed on a flat ground.



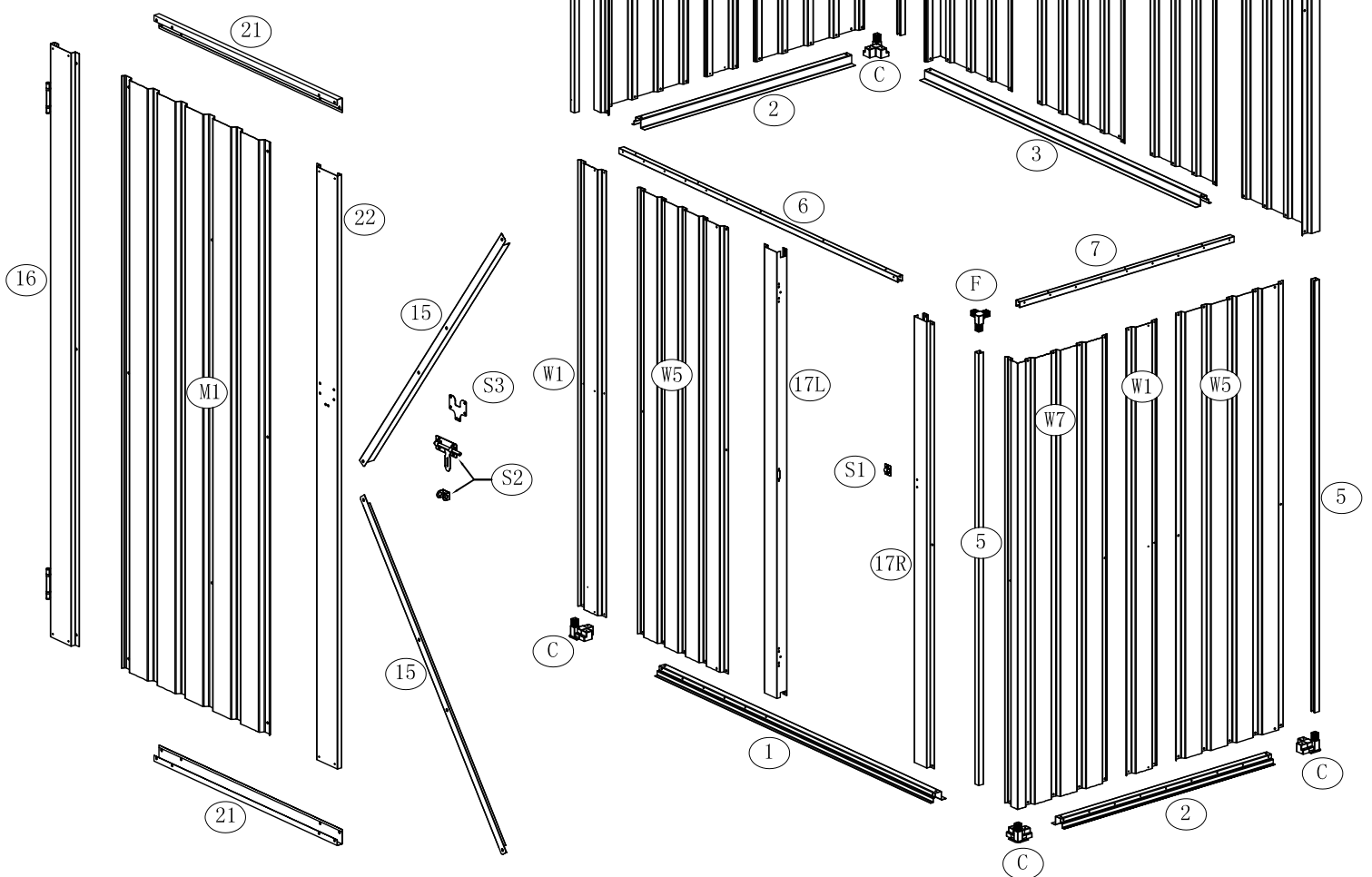
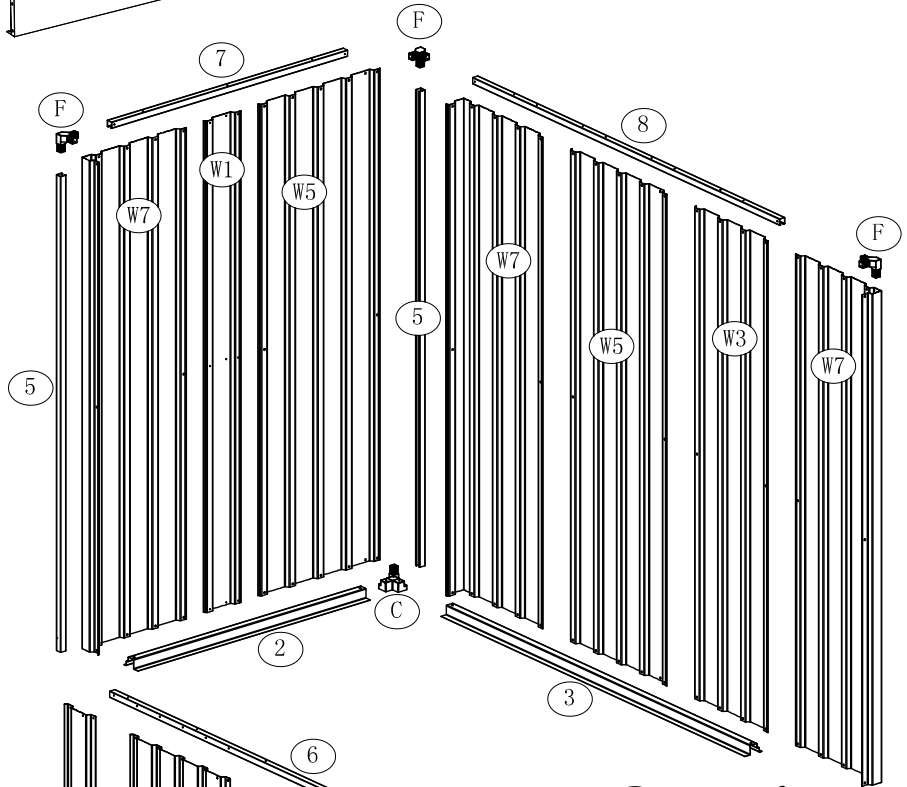
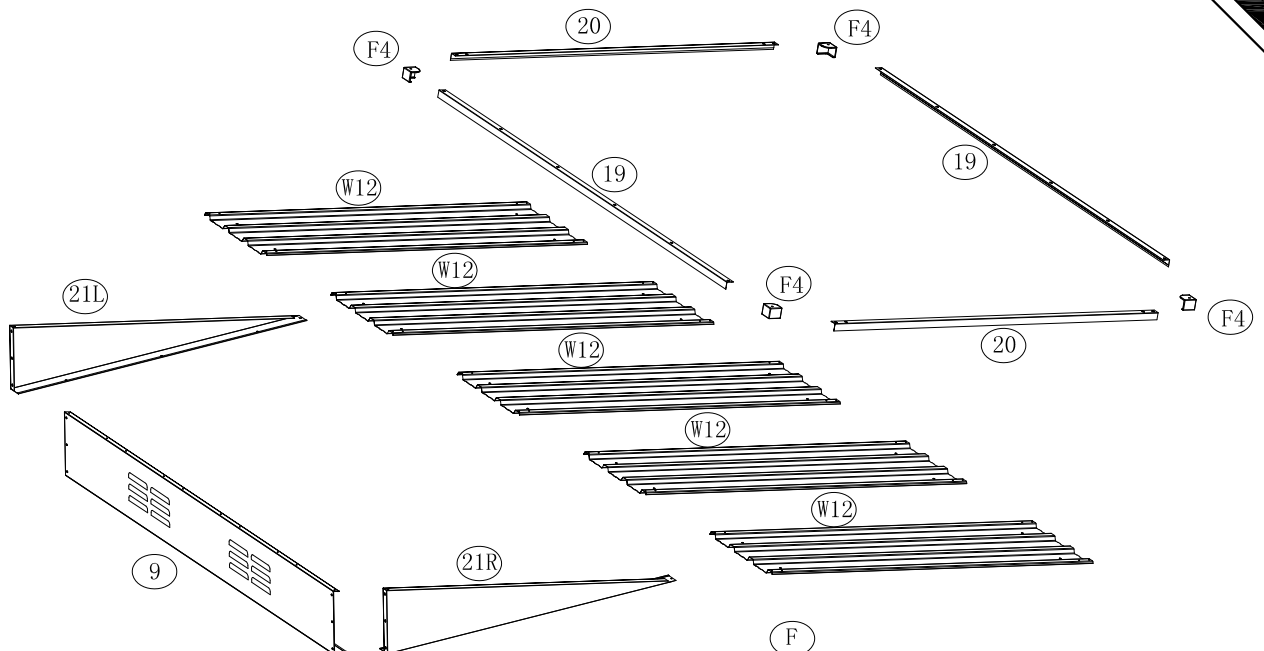

PLEASE KEEP THIS INSTRUCTION FOR FUTURE REFERENCE.

NO.	PART.	Qty.
1	 1416.2mm	1
2	 881.2mm	2
3	 1416.2mm	1
5	 1510mm	4
6	 1429.4mm	1
7	 894.4mm	2
8	 1429.4mm	1
9		1
15	 940.9mm	2
16	 1555mm	1
17L	 1560mm	1
17R	 1560mm	1
19	 1625mm	2
20	 1103mm	2

NO.	PART.	Qty.
21	 705mm	2
21L		1
21R		1
22	 1555mm	1
W1	 1560mm	3
W3	 1560mm	1
W5	 1560mm	4
W7	 1560mm	4
W12	 1095mm	5
M1	 1553mm	1
C		4
F		4
F4		4
F7		155



STEP 1

NO.	PART.	Qty.
1	 1416.2mm	1
2	 881.2mm	2
3	 1416.2mm	1
C		4
S4		8

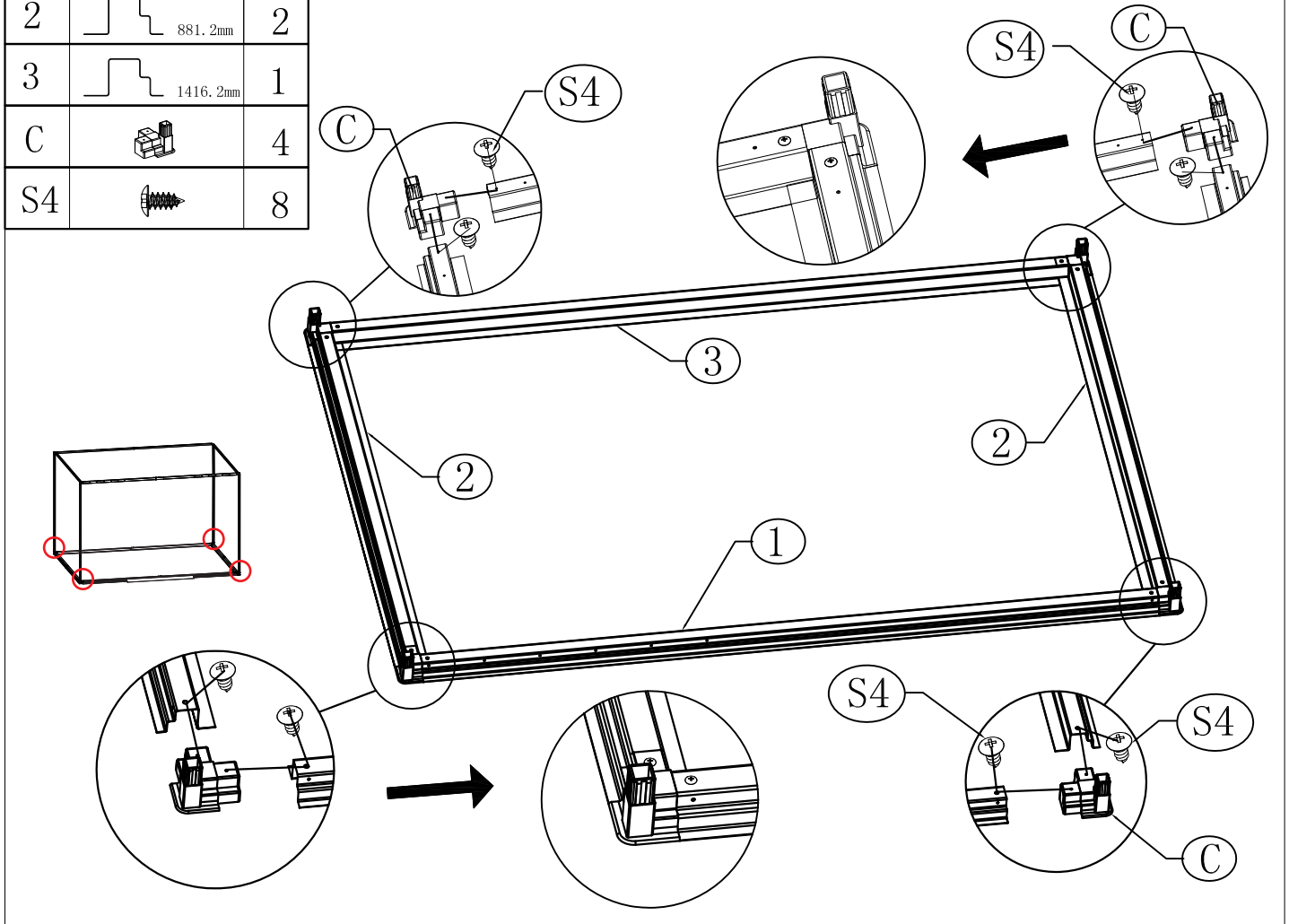



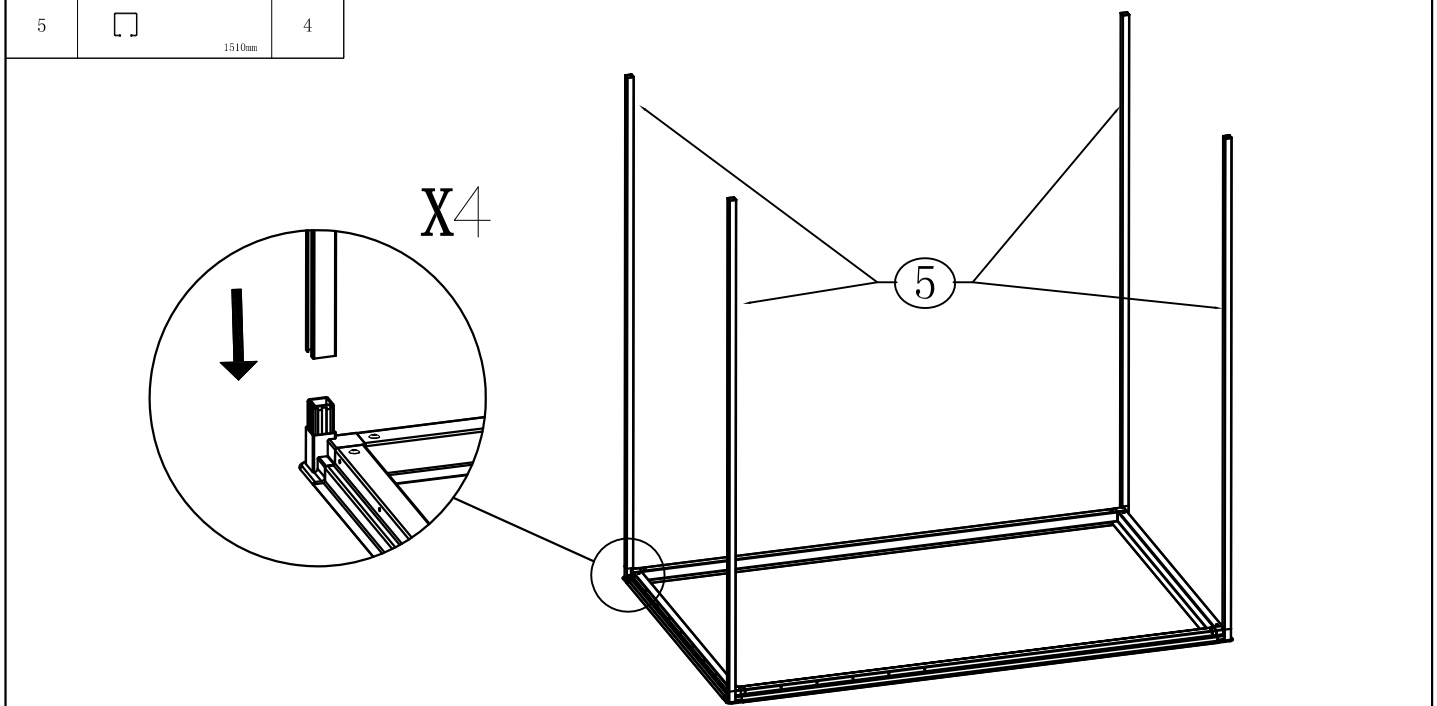

STEP 2

NO.	PART.	Qty.
5	 1510mm	4



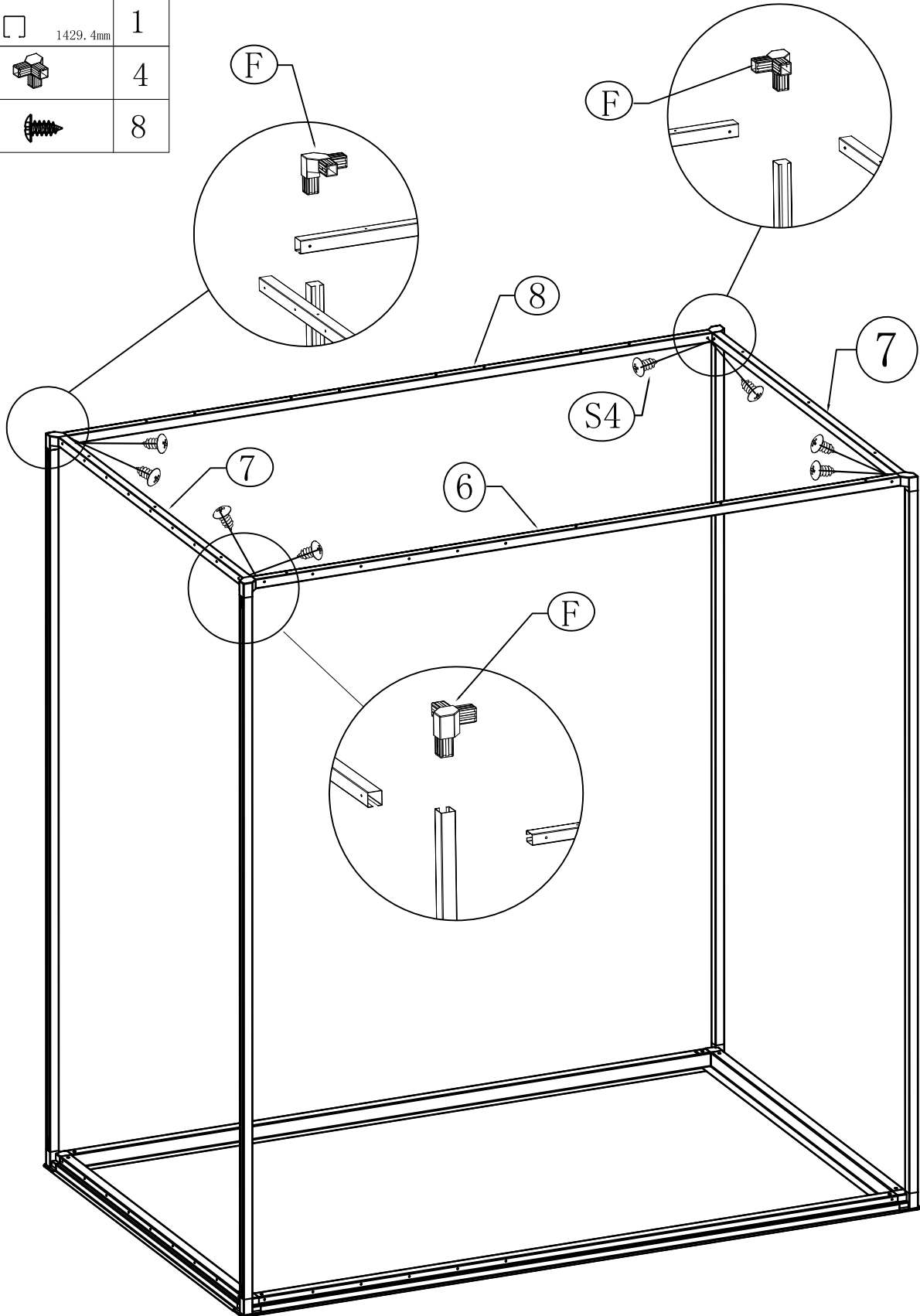

STEP 3

NO.	PART.	Qty.
6	 1429.4mm	1
7	 894.4mm	2
8	 1429.4mm	1
F		4
S4		8



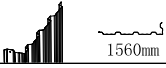



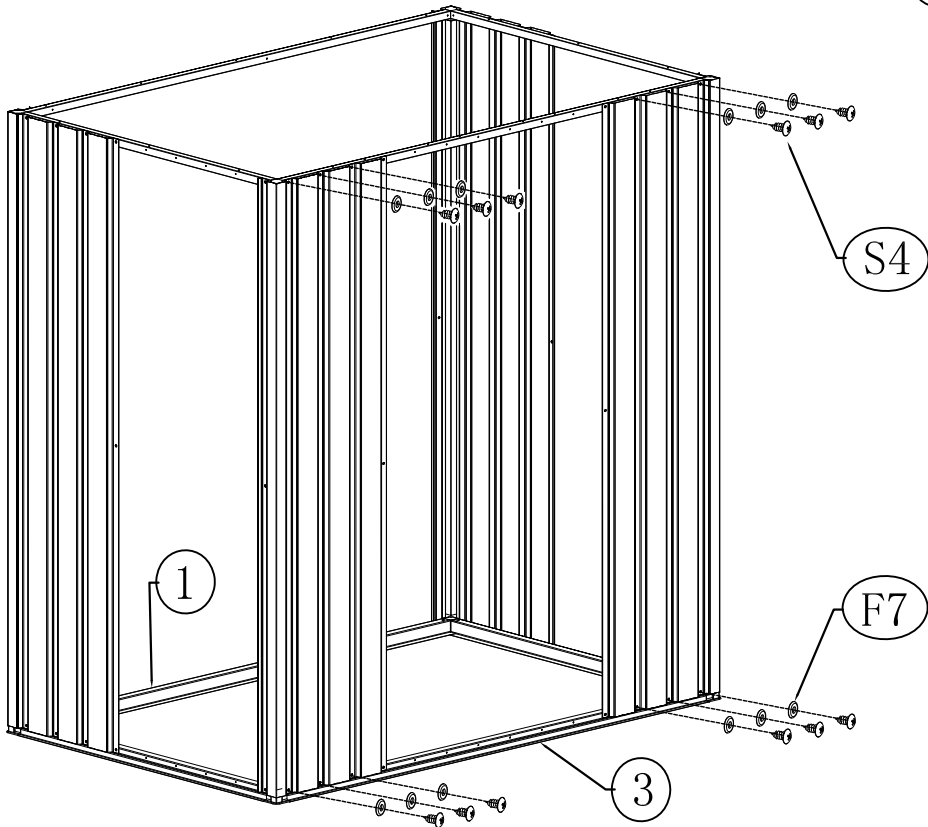
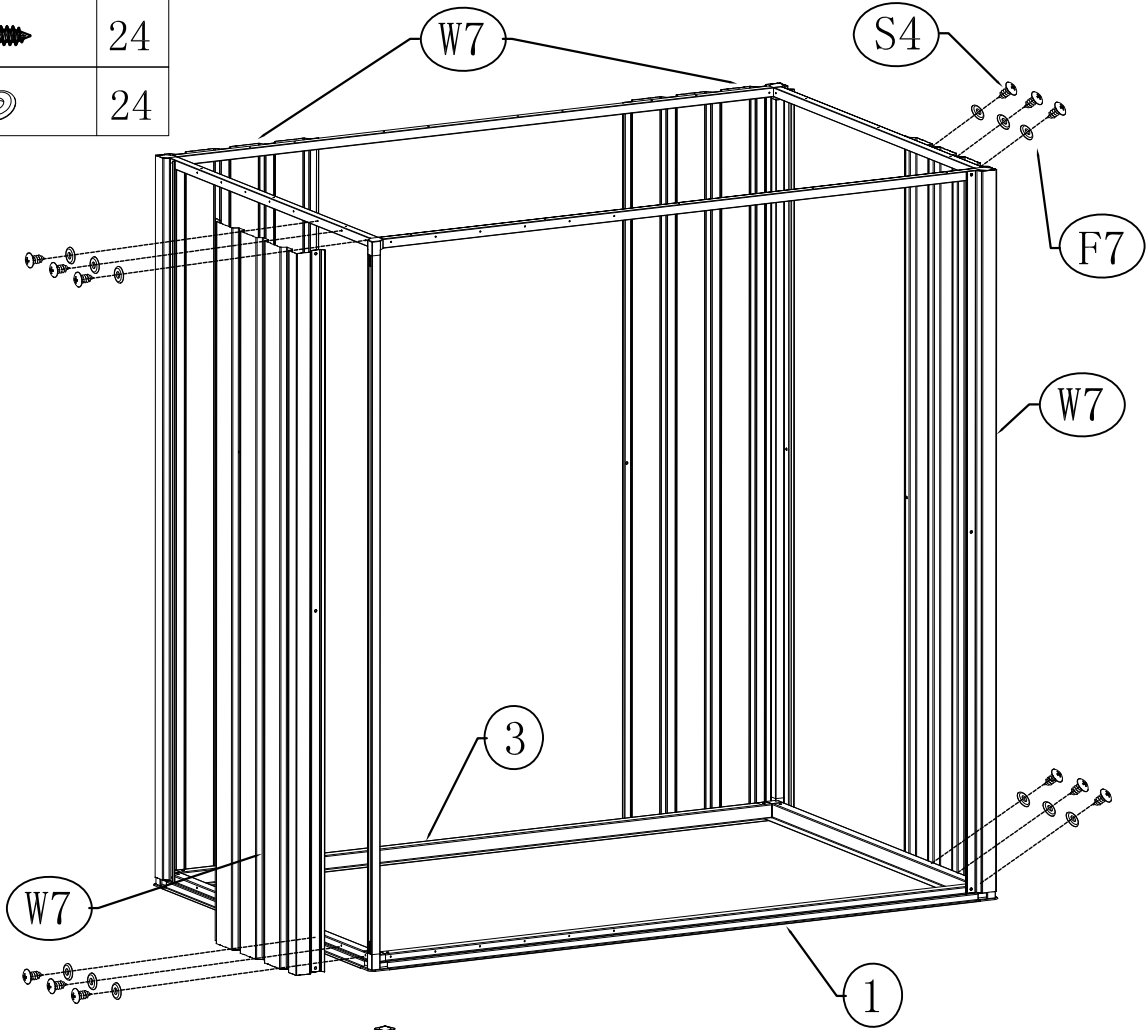

STEP 4

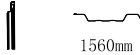
NO.	PART.	Qty.
W7	 1560mm	4
S4		24
F7		24







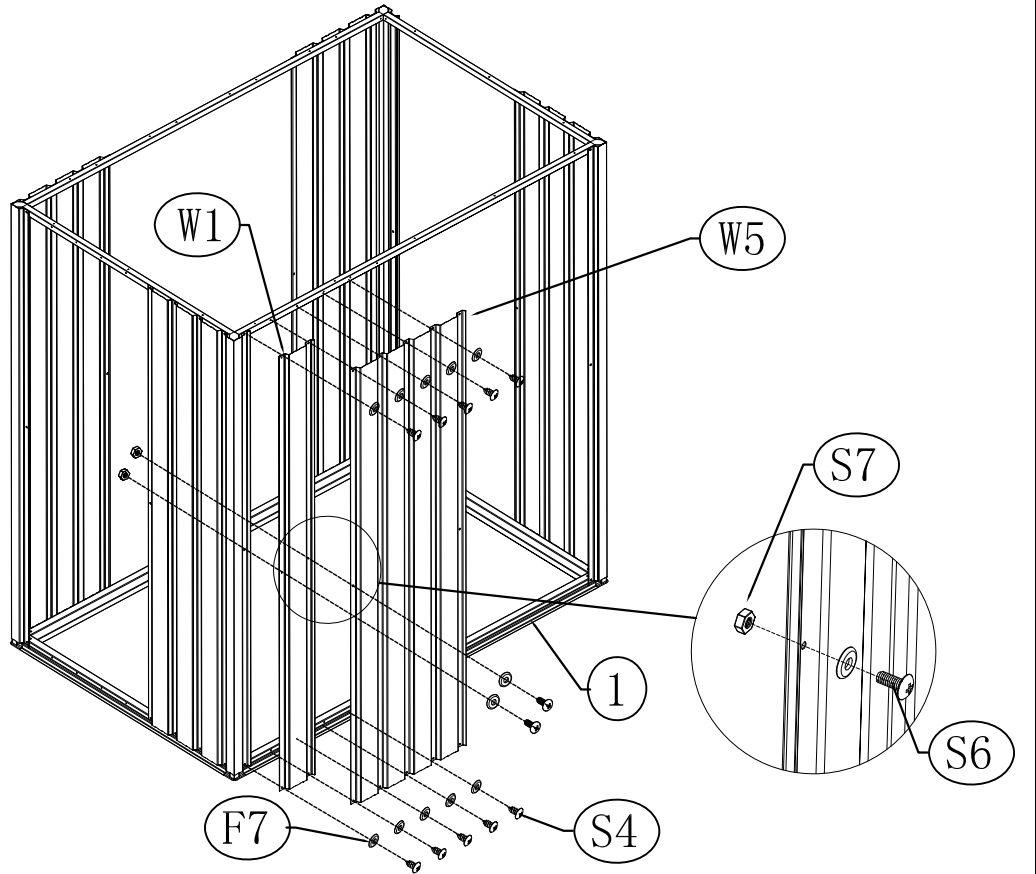

STEP 5

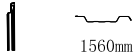
NO.	PART.	Qty.
W1	 1560mm	1
W5	 1560mm	1
S4		10
S6		2
S7		2
F7		12







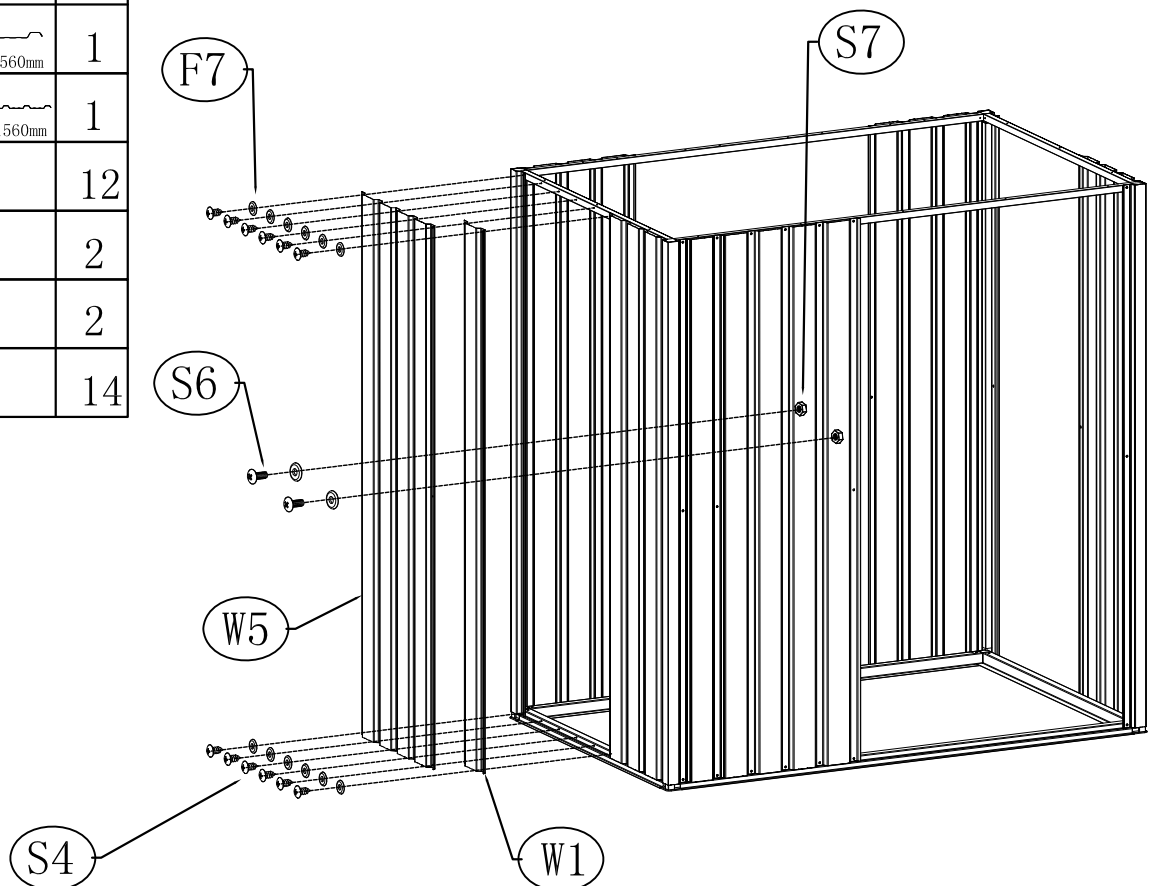

STEP 6

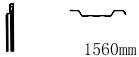
NO.	PART.	Qty.
W1	 1560mm	1
W5	 1560mm	1
S4		12
S6		2
S7		2
F7		14







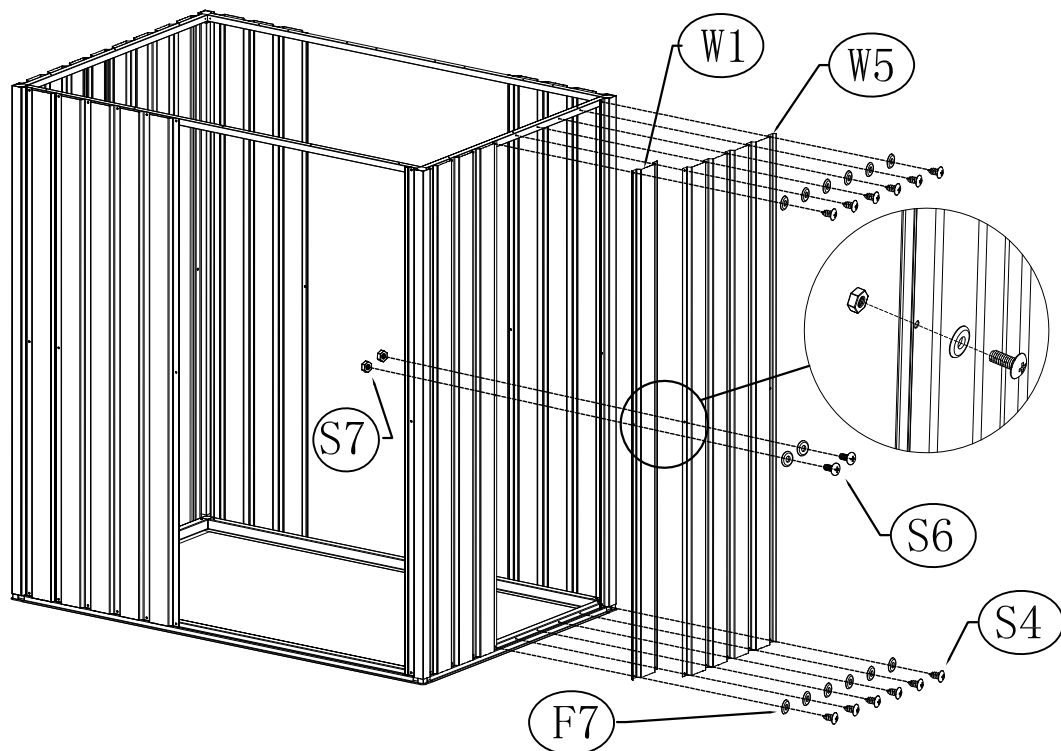

STEP 7

NO.	PART.	Qty.
W1	 1560mm	1
W5	 1560mm	1
S4		12
S6		2
S7		2
F7		14







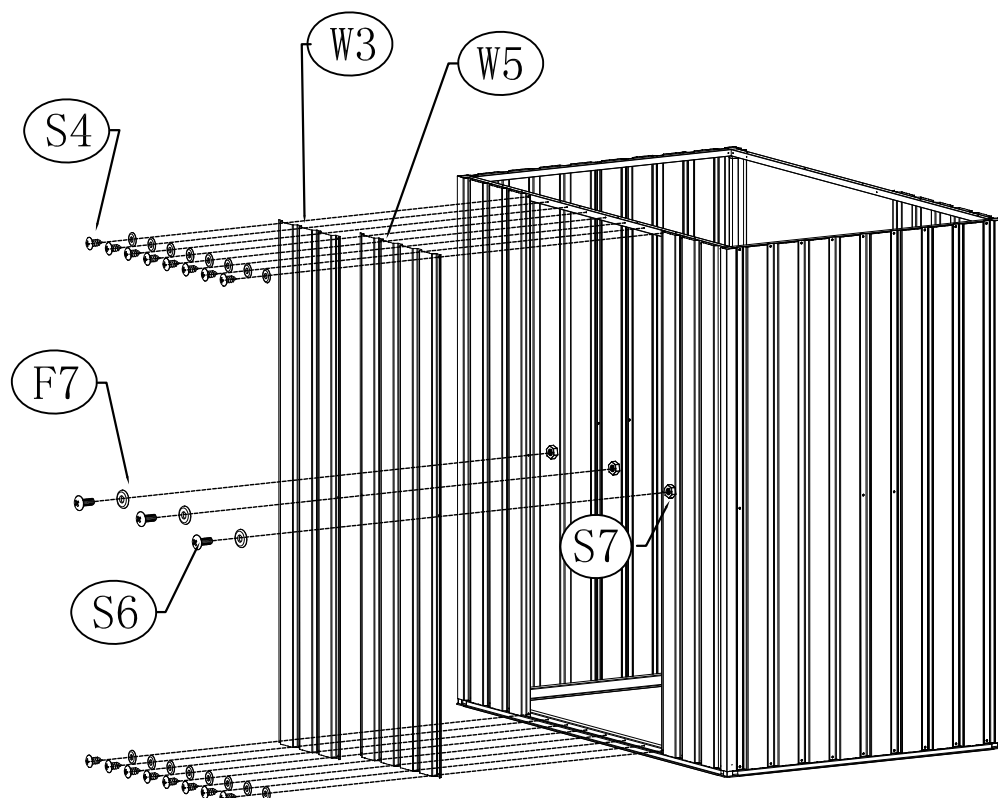

STEP 8

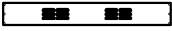
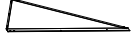
NO.	PART.	Qty.
W3	 1560mm	1
W5	 1560mm	1
S4		16
S6		3
S7		3
F7		19



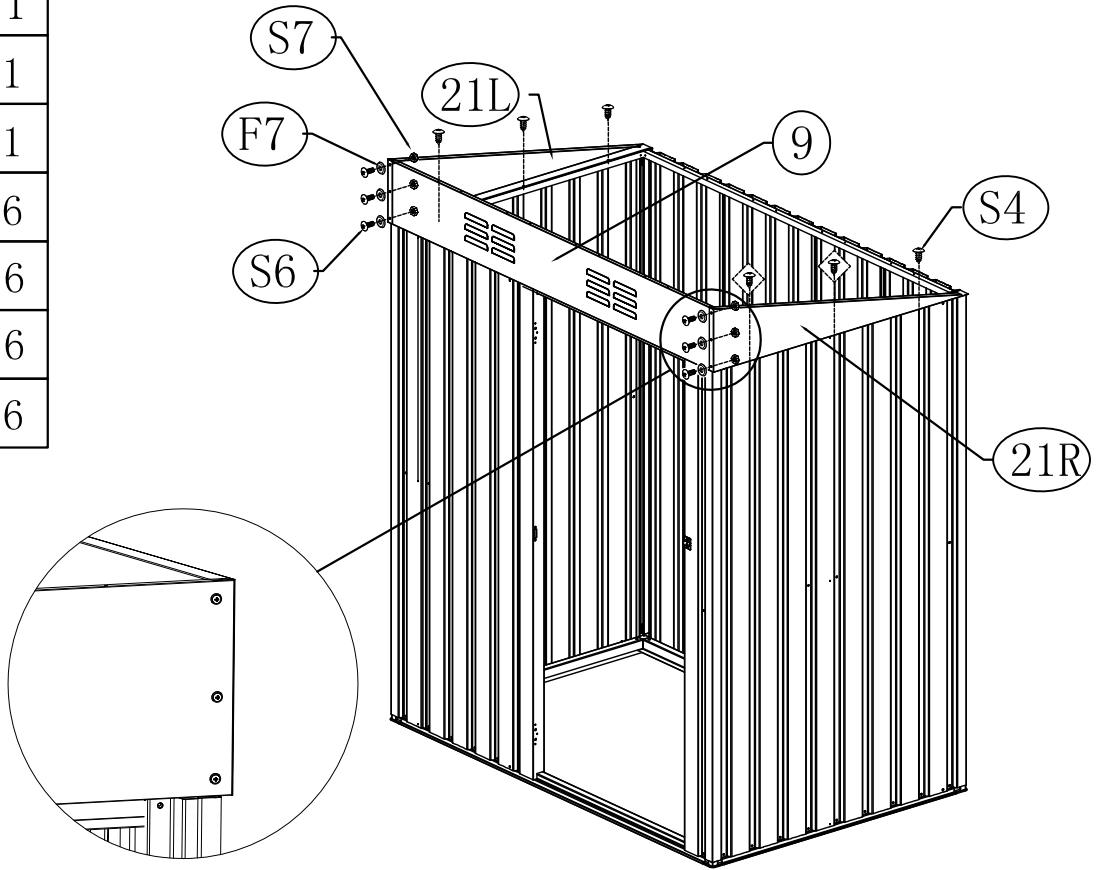

STEP 9

NO.	PART.	Qty.
9		1
21L		1
21R		1
S4		6
S6		6
S7		6
F7		6



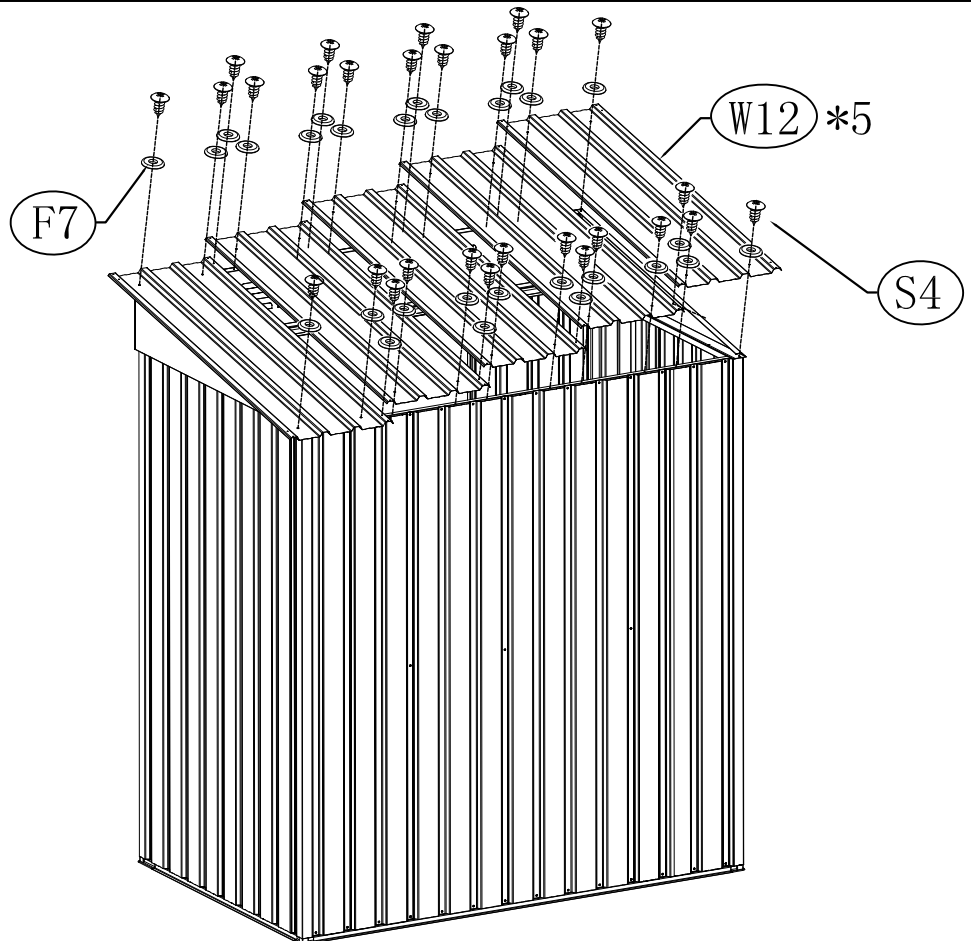

STEP 10

NO.	PART.	Qty.
W12	 1095mm	5
S4		28
F7		28





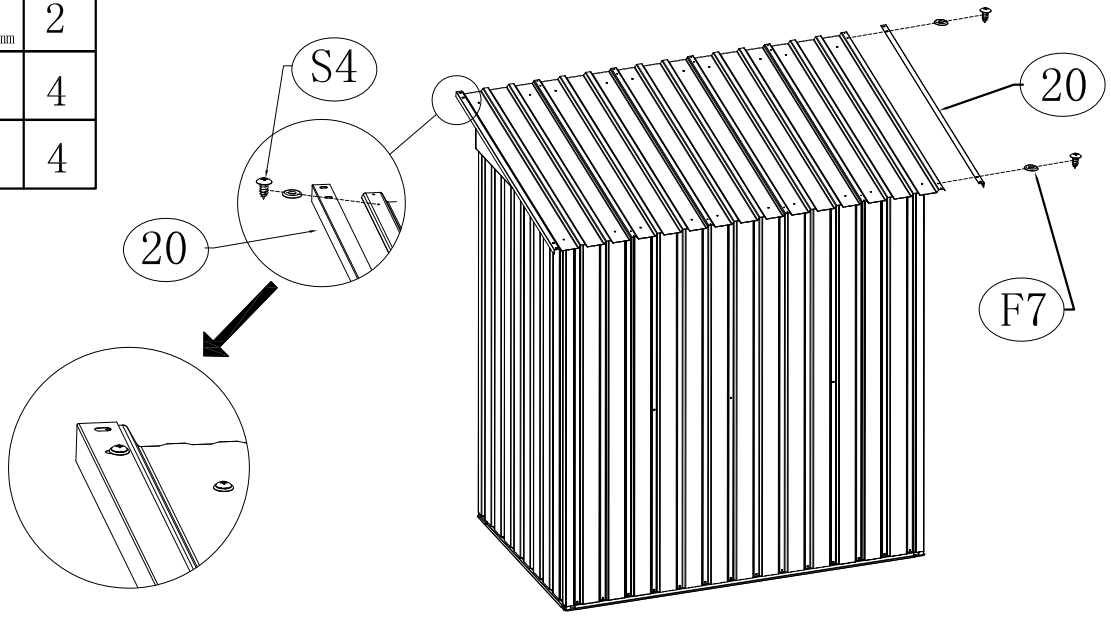

STEP 11

NO.	PART.	Qty.
20	 1103mm	2
S4		4
F7		4

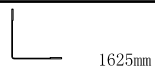

STEP 12

NO.	PART.	Qty.
19	 1625mm	2
S4		8
S8		4
F4		4
F7		12

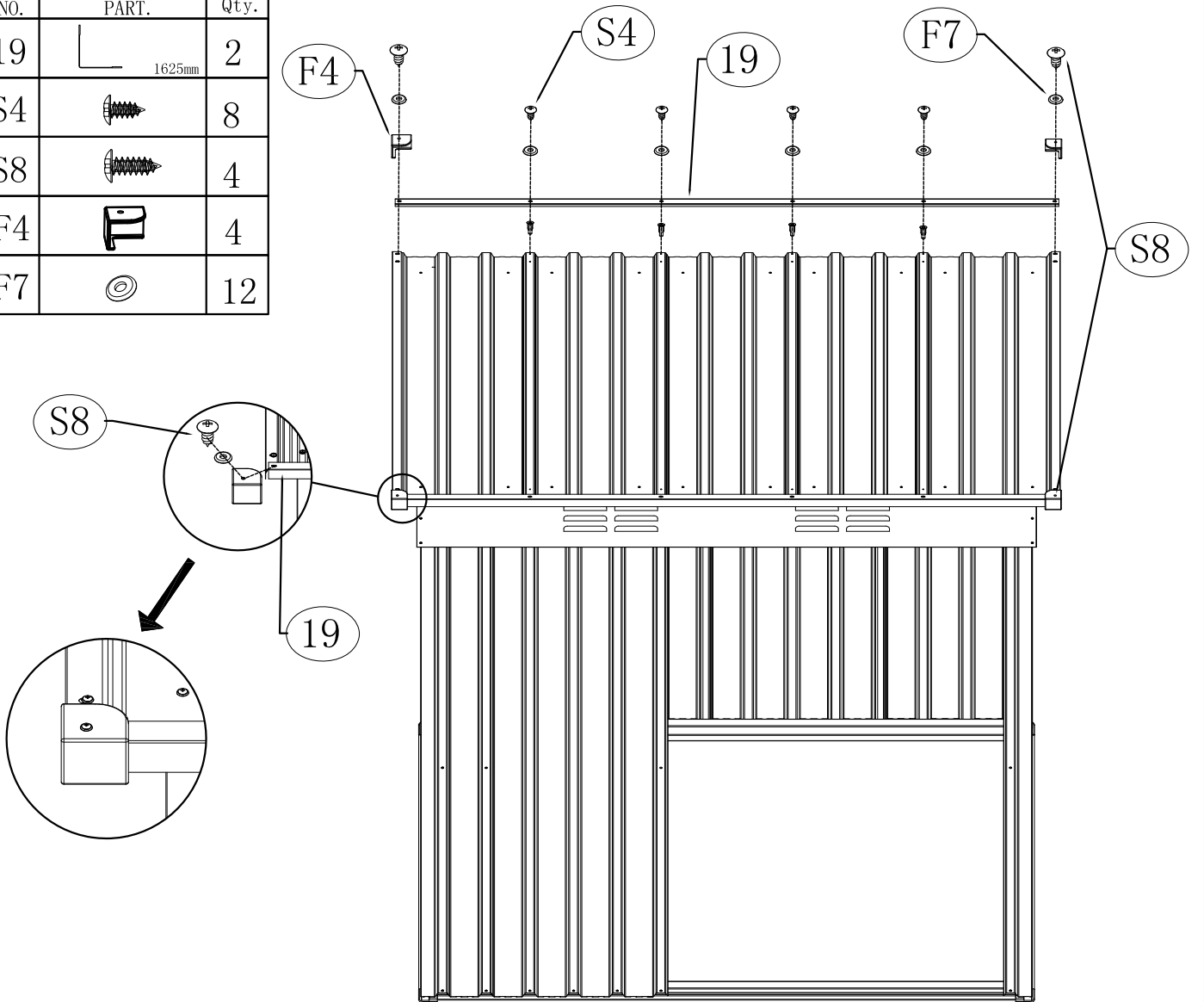





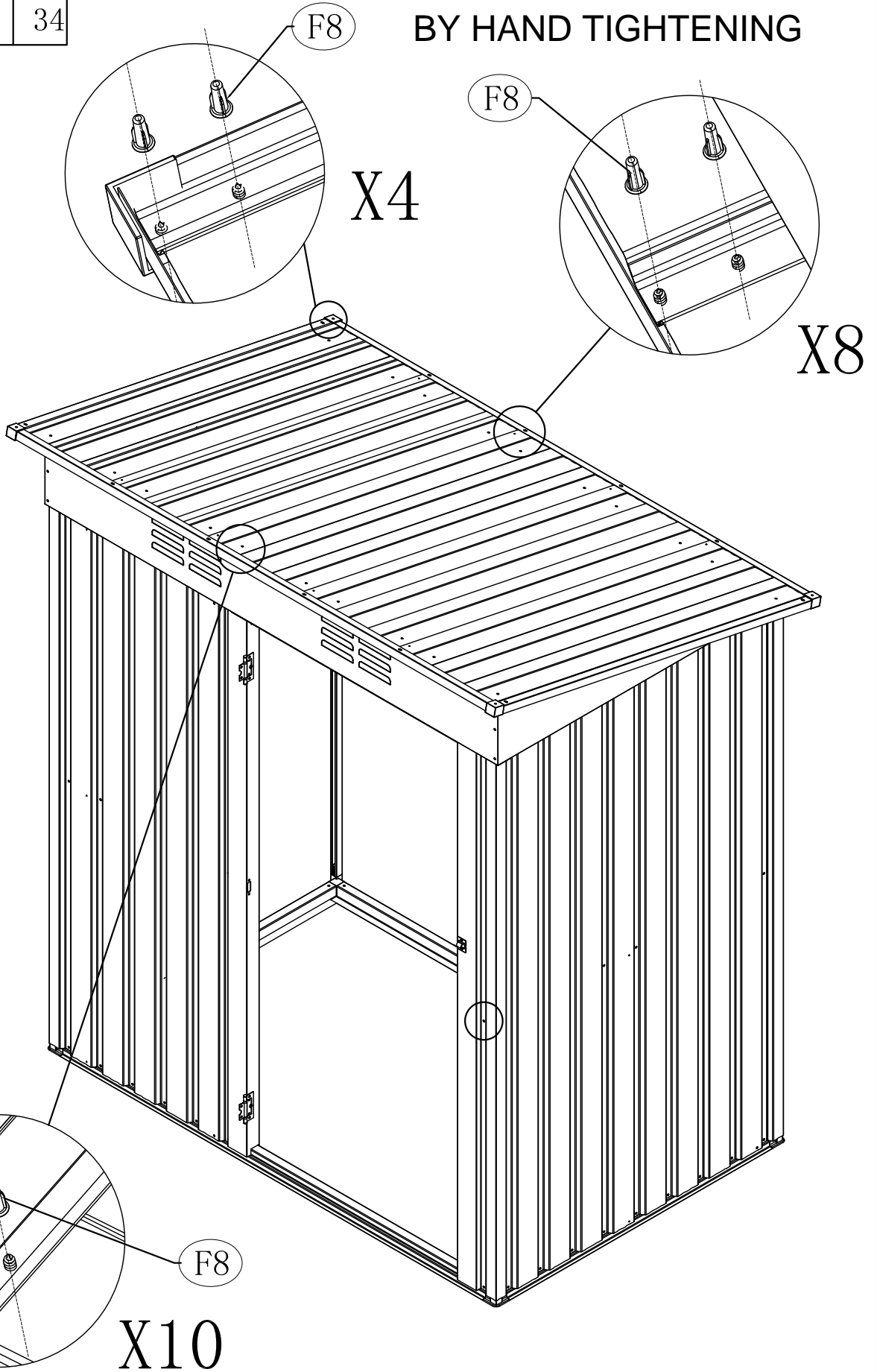

STEP 13

NO.	PART.	Qty.
F8		34

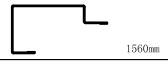
BY HAND TIGHTENING







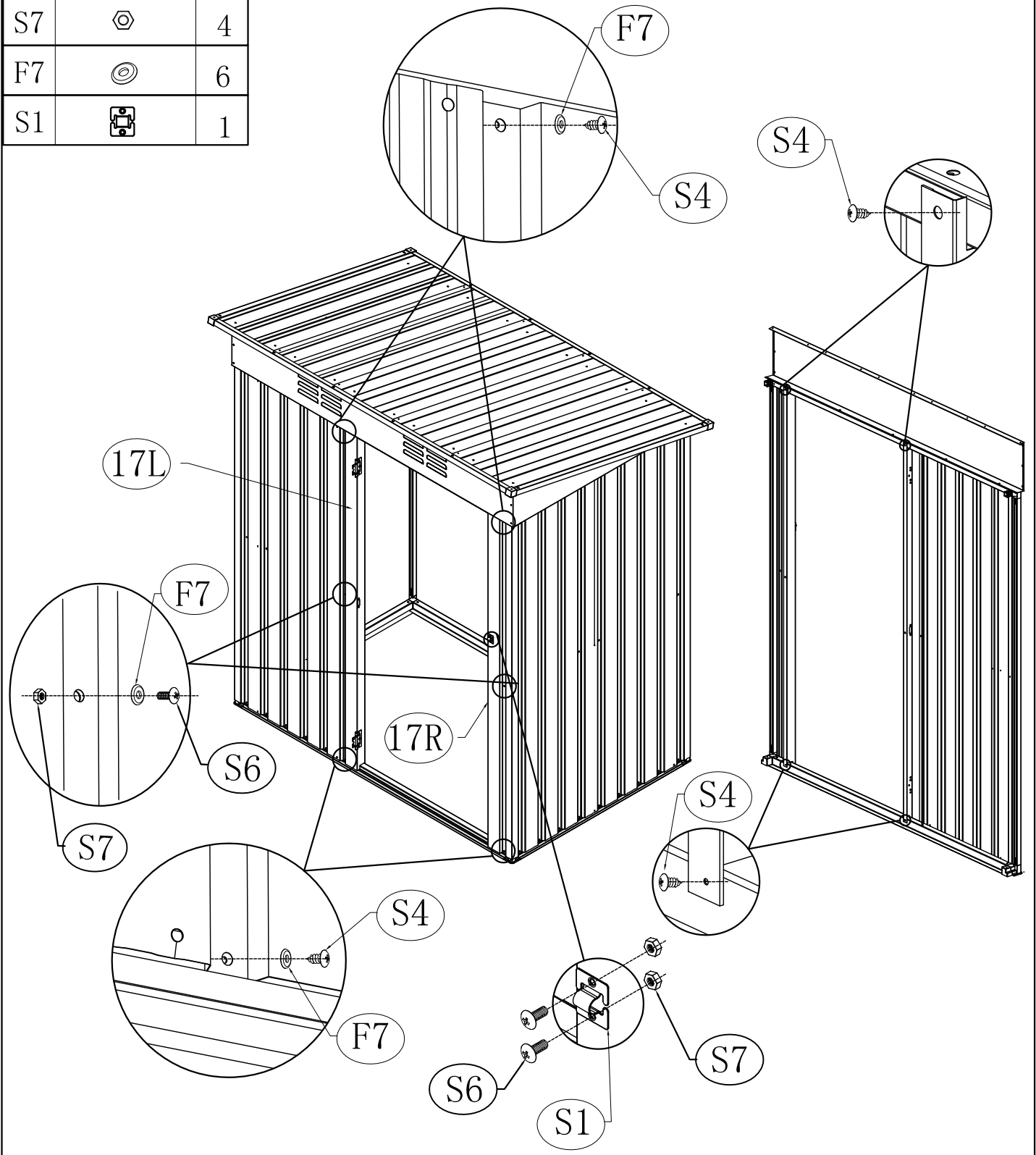

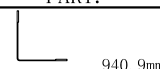
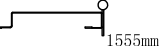

STEP 14

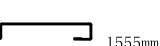
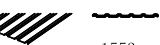
NO.	PART.	Qty.
17L	 1560mm	1
17R	 1560mm	1
S4		8
S6		4
S7		4
F7		6
S1		1



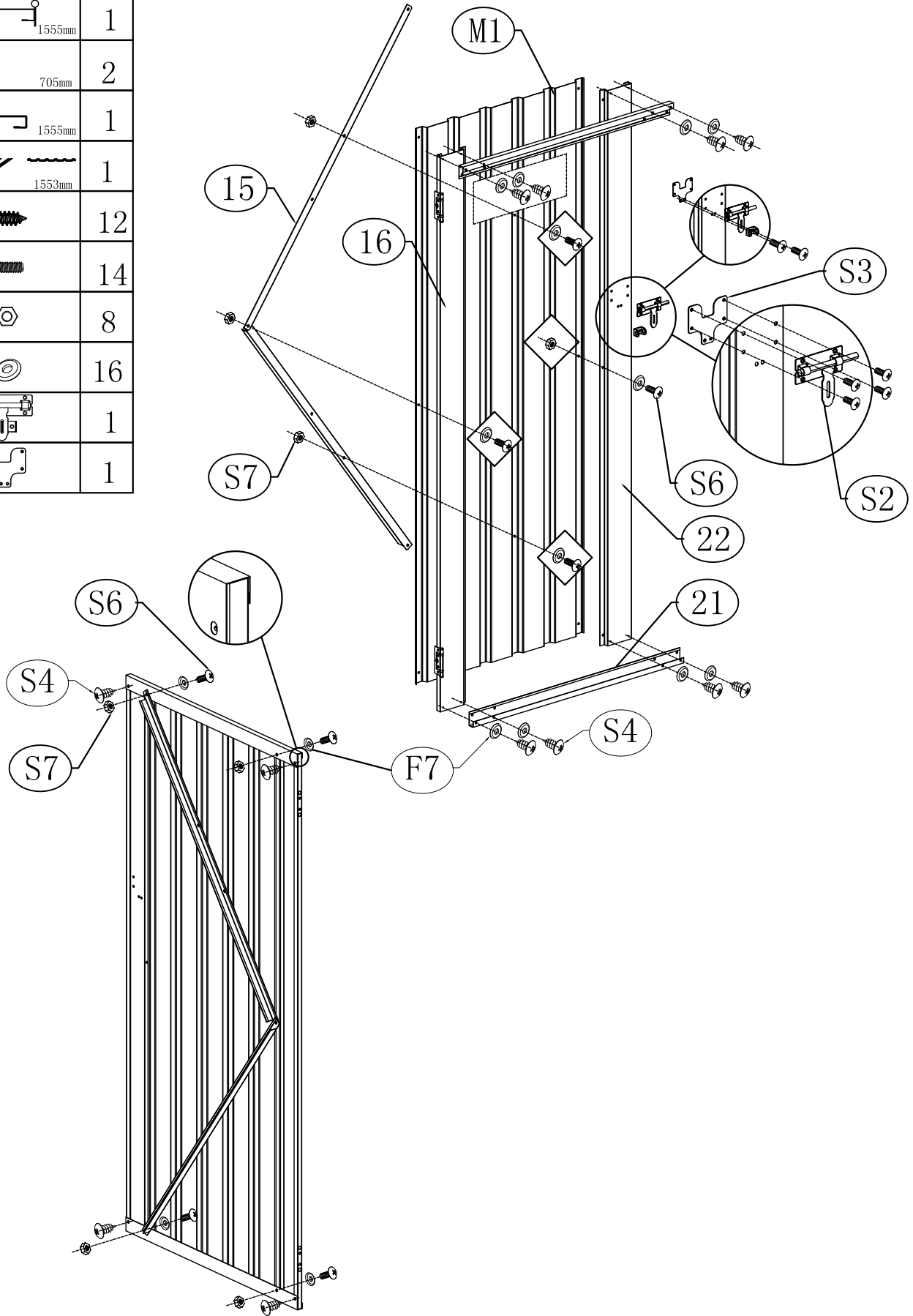

STEP 15

NO.	PART.	Qty.
15	 940.9mm	2
16	 1555mm	1
21	 705mm	2
22	 1555mm	1
M1	 1553mm	1
S4		12
S6		14
S7		8
F7		16
S2		1
S3		1



STEP 16

NO.	PART.	Qty.
S6		6
S7		6

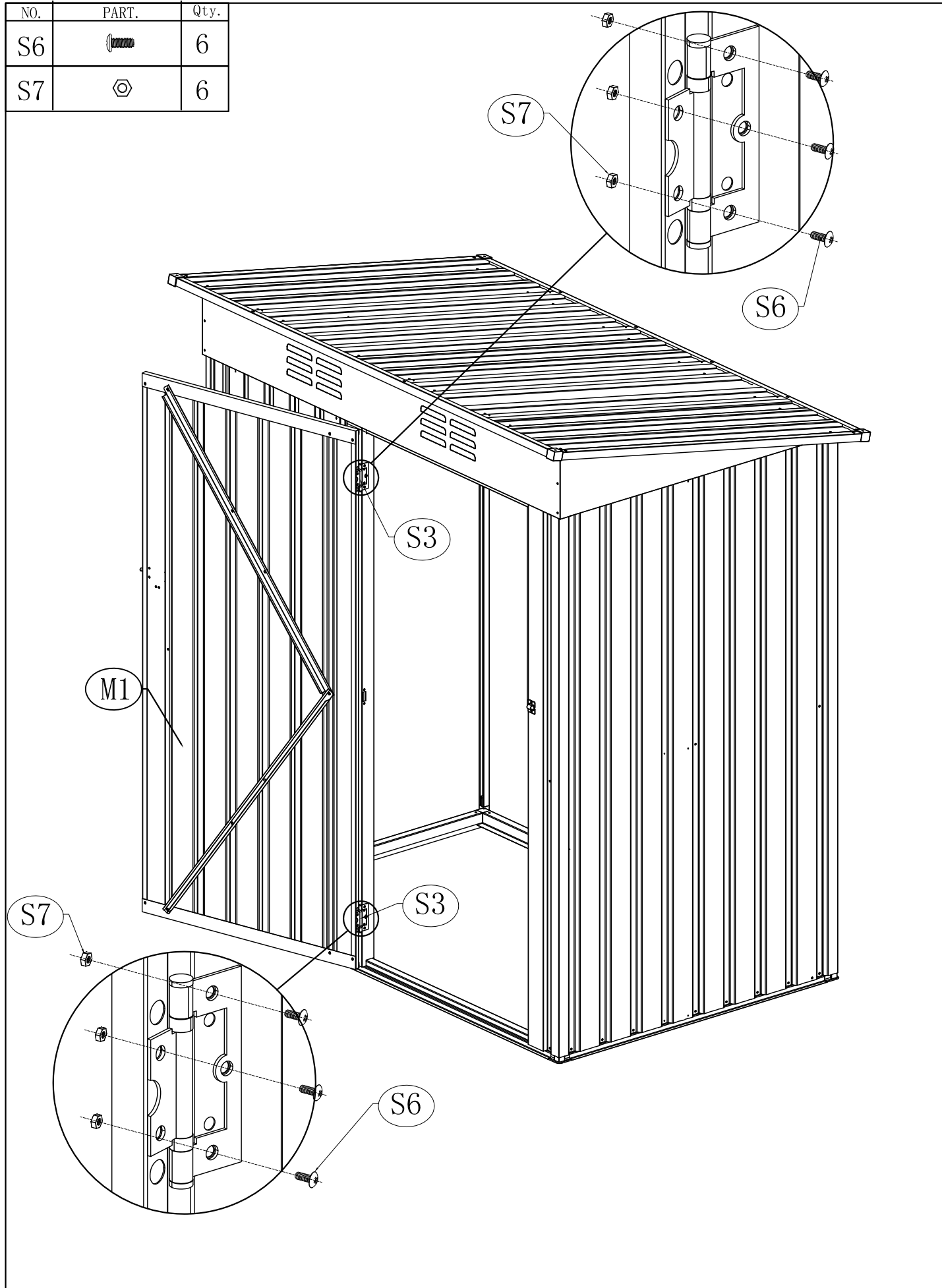

STEP 17

NO.	PART.	Qty.
S9		4

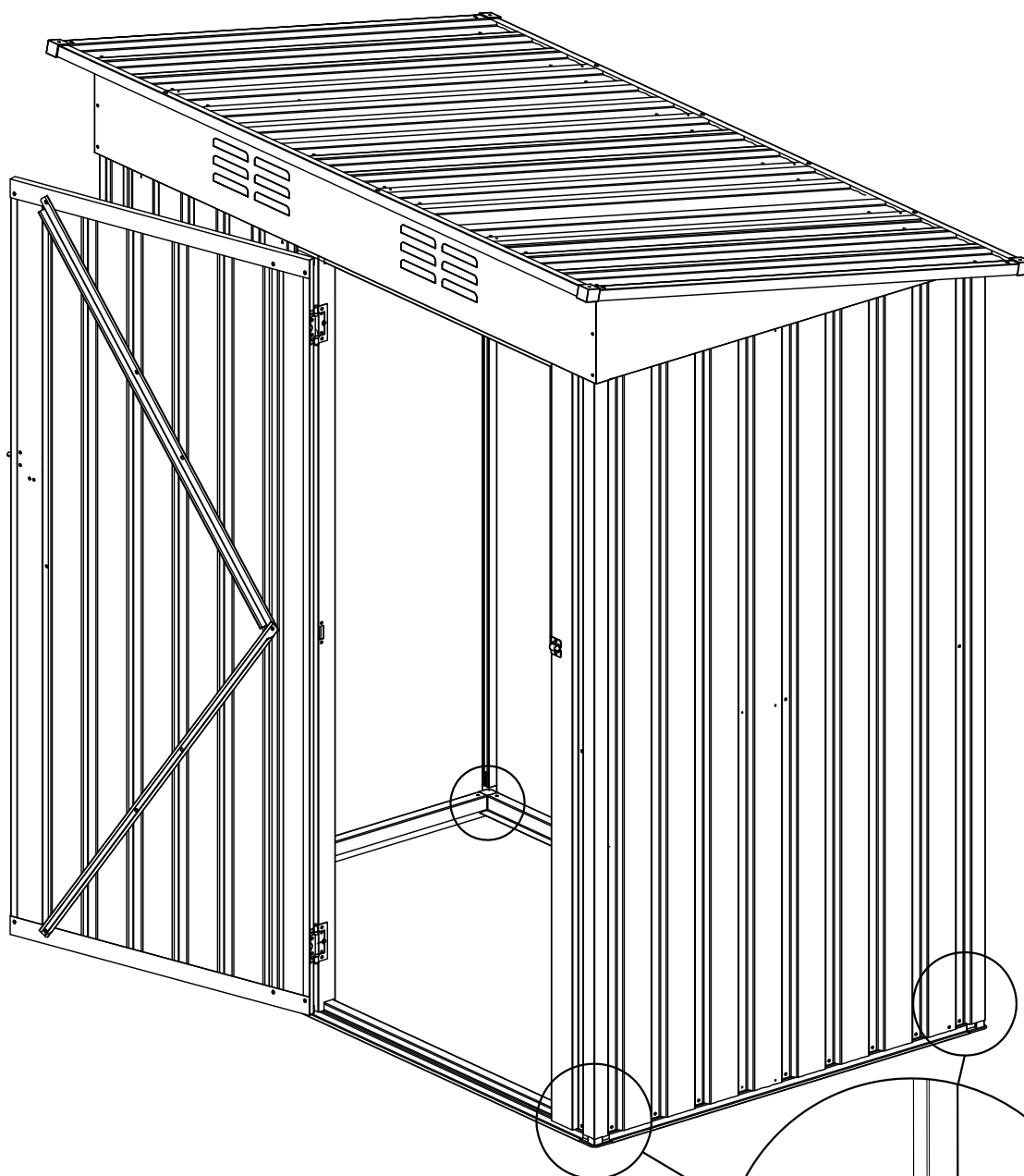

If the shed is installed on grass, the [S9] can be used to increase the stability of the shed.