



Outdoor  
Living Today

# ASSEMBLY MANUAL

## 12x12 Sunshed Garden

Stock Code:  
SSGS1212-AK-CEDAR  
SSGS1212-AK-METAL  
SSGS1212-AK-PLY

Version #2.0  
Nov 5, 2025



### CONTACT

#### ADDRESS

9393 287th Street,  
Maple Ridge, British Columbia,  
Canada V2W 1L1

#### PHONE & FAX

Toll Free: 1-888-658-1658

Fax:

#### ONLINE

Email: [olmsupport@outdoorlivingtoday.com](mailto:olmsupport@outdoorlivingtoday.com)

Web: [www.outdoorlivingtoday.com](http://www.outdoorlivingtoday.com)

# What You Need to Know

Thank you for purchasing a 12x12 Sunshed.

*Please take the time to identify all the parts prior to assembly.*

## IMPORTANT INFORMATION

It is the sole responsibility of the customer to check with your local municipal or county by-laws before ordering this product to confirm it complies with building codes in your area.

If the product is elevated, any structural and building code requirements are solely the customer's responsibility, and should be abided by.

Snow load ratings vary by geographical location. If heavy or wet snowfall occurs, it is advisable to sweep snow off roof frequently. In areas with high or gusty wind conditions, it is advisable to install the structure securely to the ground.

Have a regular maintenance plan to ensure screws, doors, windows and parts are tightly affixed.

All structures purchased from Outdoor Living Today are covered for a period of one year for defects in manufacturing and workmanship. Costs incurred for customer installations are not included.

***Failure to use supplied parts included in this kit could result in poor product performance and may void your warranty. Please contact Outdoor Living Today's Customer Toll Free Line if you plan to deviate from our written instructions.***

## Warranty

In the event of a missing or broken piece, please contact Outdoor Living Today **Customer Support at [olmsupport@outdoorlivingtoday.com](mailto:olmsupport@outdoorlivingtoday.com) within 30 days of the delivery of your purchase.** It is our commitment to you to courier replacement parts, free of charge, **within 10 business days of this notification.** Replacement parts will not be provided free of charge after the 30 day grace period.

**Customer agrees to hold Outdoor Living Today and any Authorized Dealers free of any liability for improper installation, maintenance and repair.**

# What to do Before my Shed Arrives?



Become familiar with this assembly manual and determine if you can complete the project yourself or will require a professional contractor.



One helper is recommended to assist in constructing your shed. It generally takes two people two days to assemble a shed. If you're hiring a contractor, their rate should be in line with that duration of work.



Clear the construction area and ensure a clear pathway for delivery when the freight company arrives. Remove all debris: roots, grass, rocks, etc.



Excavate the site. Contact your local utilities company to ensure there are no gas or electric lines buried in the area before digging.



Decide on the type of foundation you will be using: Concrete slab, or 4-6 inches of crushed gravel with paver stones or 4x4 stringers.

You can find the footprint for your shed on Page 3 of your Assembly Manual.



If doing the assembly yourself, have all the necessary tools ready to go and in working condition. A list of required tools can be found after the parts list.

## Foundation Types for 12x12 Garden Shed

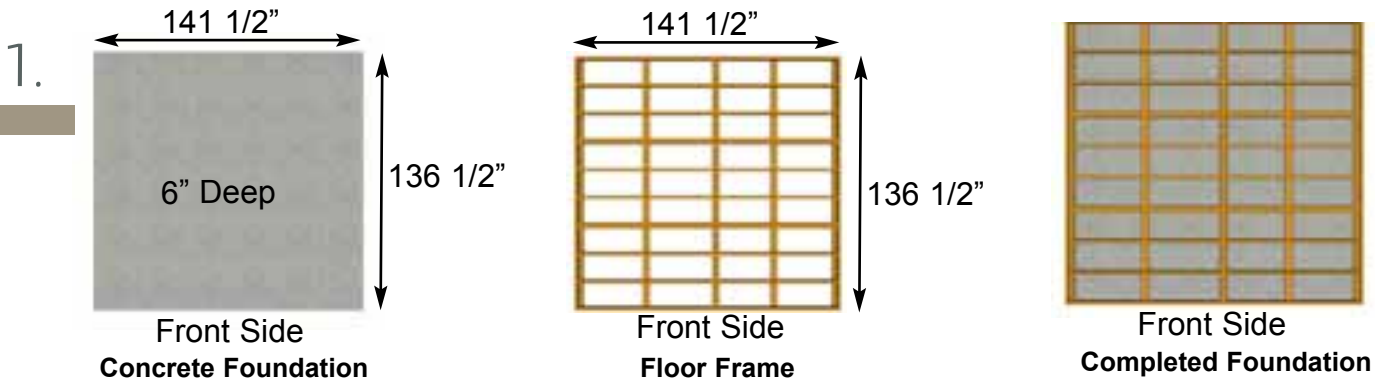

### Concrete Slab Foundation:

- Slab must be at least the same size as assembled floor frame (141 1/2" x 136 1/2") or larger.
- 6" Deep foundation.
- 2.5 Cubic Yards of concrete required.
- A concrete slab will have the longest durability out of your foundation options.

Once level, a concrete slab is the easiest surface to build on.

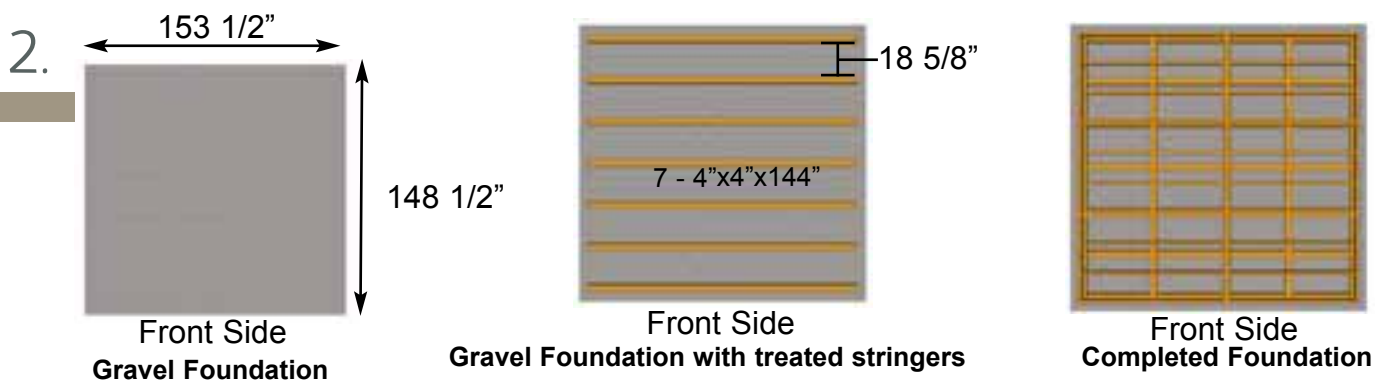

### Gravel with 4x4 Pressure Treated Stringers:

- Excavate at least 6" deep, and 6" wider than floor frame on each side.
- 3.0 Cubic Yards of gravel required, approximately 27 wheelbarrows.
- 7 - 4x4 Pressure Treated Stringers 12' long required.
- Evenly spaced, with one at each end of floor frame.

Saves money on materials, easy to level and work with.

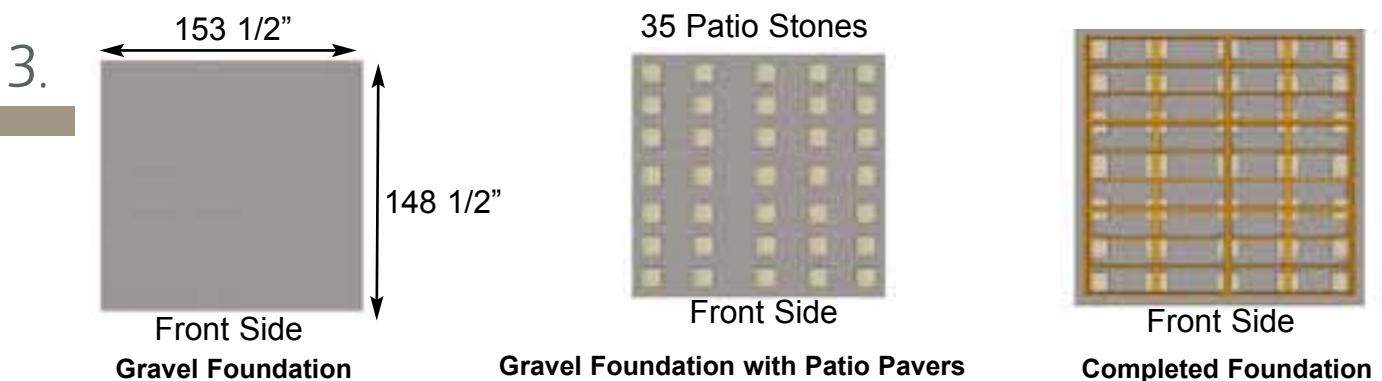













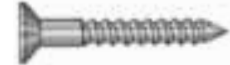





### Gravel with Patio Paver Stones:

- Excavate at least 6" deep, and 6" wider than floor frame on each side.
- 3.0 Cubic Yards of gravel required, approximately 27 wheelbarrows.
- 35 patio pavers (8" x 8" or larger).
- Center patio paver stones underneath floor runners and underneath seams in floor joists.







Patio paver stones are widely available from most landscape stores.



## Hardware Kit (Provided)

2 1/2" Brown Screw 	2" Brown Screw 	1 1/4" Brown Screw 
380 pcs	180 pcs	360 pcs
1" Silver Screw 	3/4" Silver Screw 	2" Blackheaded Screw 
56 pcs	16 pcs	28 pcs
3/4" Blackheaded Screw 	1 1/2" Finishing Nail 	1 1/2" Shingle Nail 
10 pcs	660 pcs	60 Pcs
Square Drive Bit 	Door Handle 	Tee Hinge 
1 pc	1 pc	4 pcs
Single Rafter Bracket 	Double Rafter Bracket 	Black Drop Latch 
6 pcs	4 pcs	1 pc
90° Metal Bracket 	Ridge Board Connector 	Silver Barrel Bolt 
8 pcs	1 pcs	1 pc
Silicon Caulking 		

## Hardware Kit - CEDAR ROOF (Provided)

2 1/2" 	x 20	1" Silver 	x 24	
1 1/4" 	x 32	1 1/2" Shingle 	x 36	
1 1/2" 	x 12			





90° Metal Brackets x 8

## Hardware Kit - METAL ROOF (Provided)

1 1/4" 	x 52	1/4" x 1 1/2" Metal Roof Screw 	x 36	
1" Silver 	x 36	1/4" Nut Driver 	x 1	

Metal Roof Hanger x 3

## Hardware Kit - PLYWOOD ROOF (Provided)

2 1/2" 	x 8	1" Silver 	x 24	
1 1/4" 	x 68	3/4" Silver 	x 12	

90° Metal Brackets x 8

## Tools Required (Not Provided)

Hammer



Screw Gun/Drill



Tape Measure



Wood Clamp



Caulking Gun



Level



Pliers



Ladder



1/8" & 3/8" Drill Bits



## Safety Equipment Required (Not Provided)

Safety Glasses



Work Gloves



**Assembly Manual shows instructions for the Sunshed with three different roof options. Please proceed to correct roof section depending on your selected roof type after rafter installation. The Parts List shows differences in some part sizes between our different types of siding.**



# Regular Maintenance & Tips to Prolong the Life of Your Shed.

## Before/During Assembly:

- 1.) Paint each face and edge of your plywood floor with a latex exterior paint.
- 2.) Caulk wall seams if gaps appear.
- 3.) Caulk around window framing (if applicable).
- 4.) Caulk perimeter between floor plywood and bottom wall plate.
- 5.) Caulk channels in lap siding at the top of your door above the trim, just a drop in each channel.
- 6.) Caulk edge of door threshold (if applicable).
- 7.) Optional: Install a Sill Gasket between floor runners and foundation.
- 8.) Optional: Install an 8" strip of roofing paper below Cedar Ridge Caps for Cedar Roof Sheds.

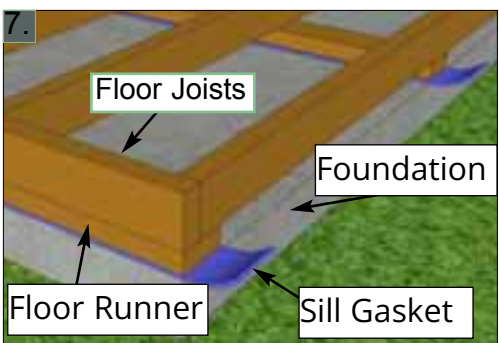
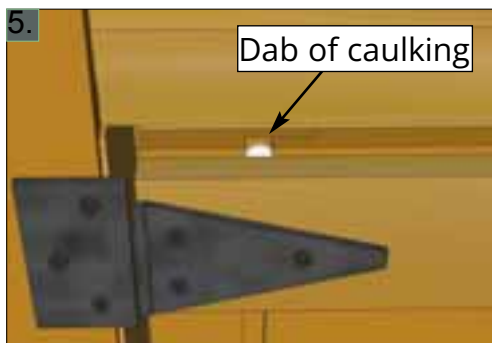
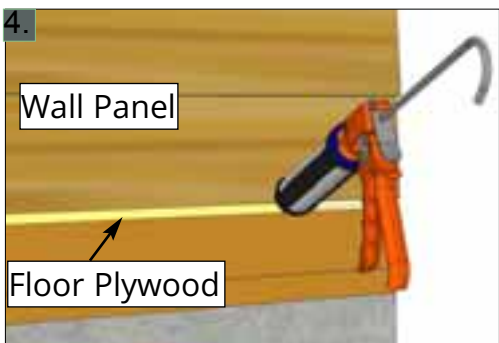

## Routine Maintenance:

- Routinely check all fasteners are tight (ex. Door Hinges, Nails)
- Brush off dirt from walls.
- Brush off snow from roof regularly.
- Routinely remove needles and leaves from roof.

## Painting/Staining

- Your cedar shed, if left untreated, will weather to a silvery grey colour.
- Painting or staining your structure is highly recommended and will prolong the life of your shed.
- You do not need to wait to paint or stain your shed, the wood in your kit has been dried and can be stained or painted immediately.
- Consult your local paint store for the best paint or stain for cedar.
- Optional: stain the inside of your shed. (Note: this will remove the fresh cedar smell.)

# A. Floor Section

Exploded view of all parts necessary to complete Floor Section. Identify all parts prior to starting. Note: Floor Footprint is 136 1/2" deep x 141 1/2" wide.

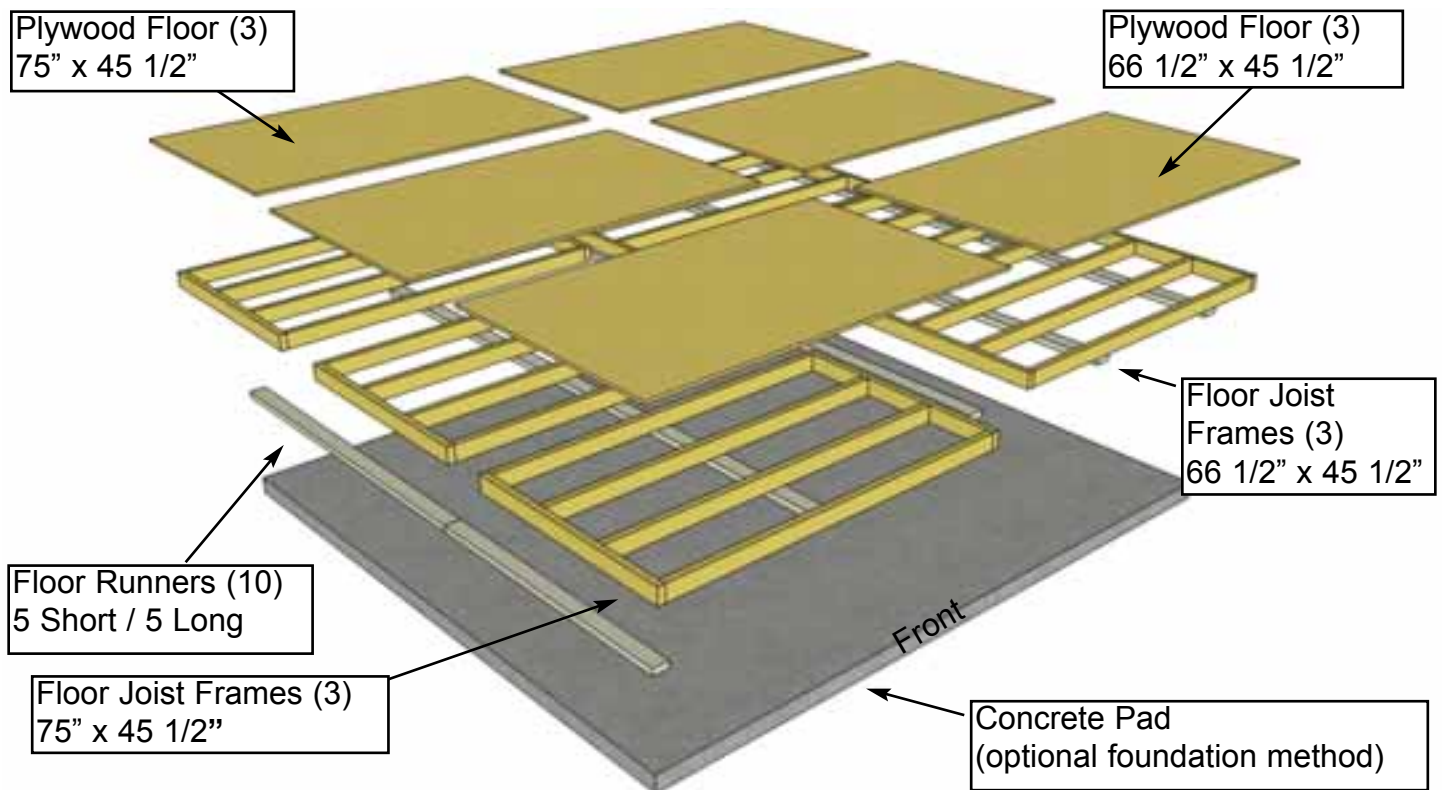



Flush with framing

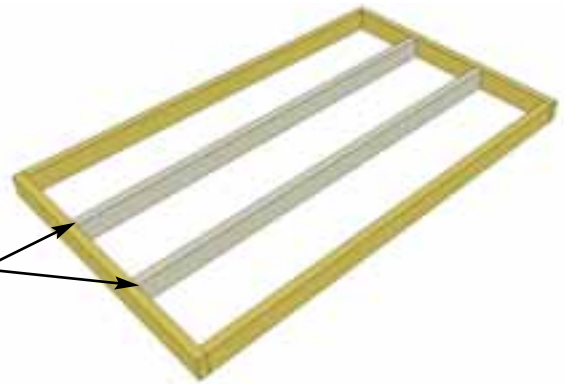

**A1.** Lay out all **Floor Joist Frames and Floor Joists** on ground as illustrated above. Position 71 7/8" Floor Joists in 75" frames and 63 1/2" Floor Joists in 66 1/2" frames. Position Joists equally in Floor Joist Frame. Position Joist so flush with framing.

Parts (Steps A1 - A5)

**Floor Joists**

(1 1/2" x 3 1/2" x 71 7/8") x 6

**Floor Joists**

(1 1/2" x 3 1/2" x 63 1/2") x 6

**Floor Joist Frames - Large**

(45 1/2" x 75") x 3

**Floor Joist Frames - Small**

(45 1/2" x 66 1/2") x 3

Hardware (Steps A1 - A5)

**2 1/2" Screws**

x 98 total

**You can find the Square Drive Bit for the screws in with the Hardware Kit Bag.**

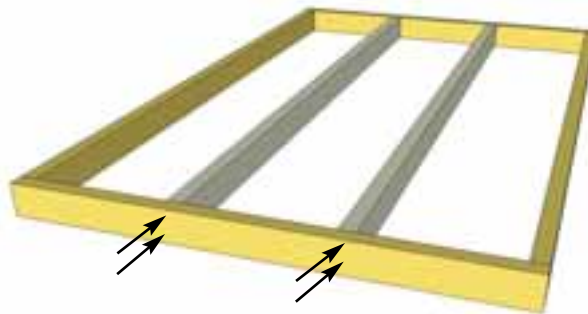

**A2.** When correctly positioned, attach each Joist with 4 - 2 1/2" Screws (2 per end). Complete all Floor Frame and Joist connections. **You can find the Square Drive Bit for the screws in with the Hardware Kit Bag.**

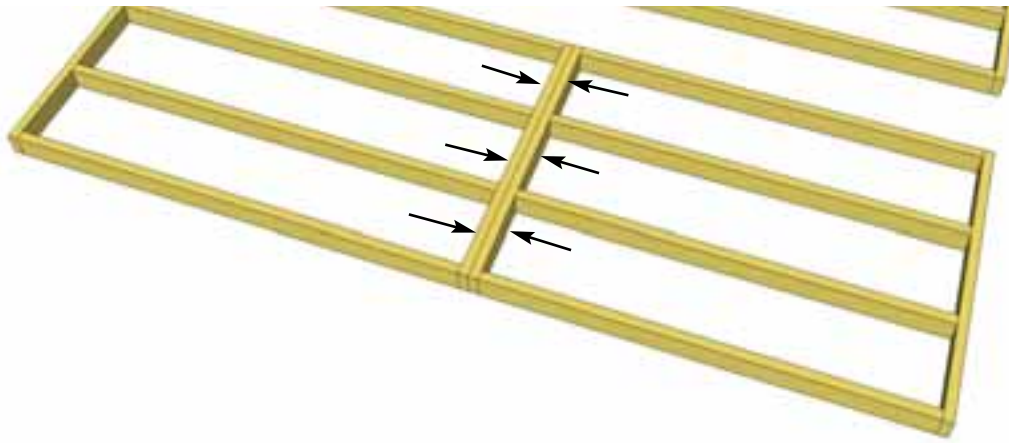

**A3.** Lay out 66 1/2" and 75" long **Floor Joist Frames** and attach together with **6 - 2 1/2" Screws**. Complete all Long and Short Floor Frames now. (3 in total).

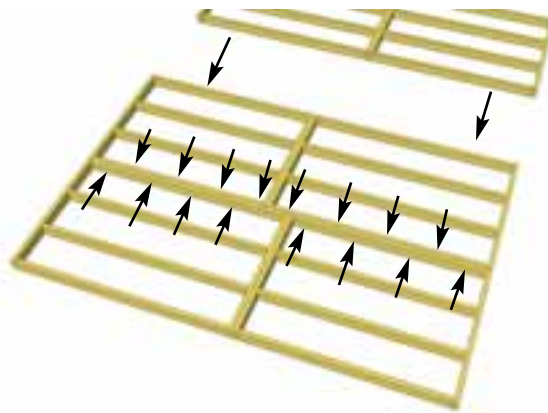

**A4.** Now attach each completed section together with **16 - 2 1/2" Screws** as illustrated above.

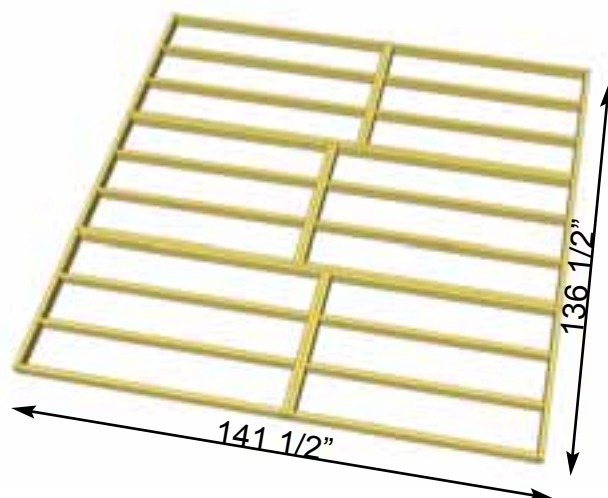

**A5.** When completed, your floor footprint should be 136 1/2" deep x 141 1/2" wide.

## Foundations



**Note:** The floor will be flipped over and floor runners will sit on your foundation. It is important to note that having a level foundation is critical. Choosing a foundation will vary between regions. Typical foundations can be concrete pads or patio stones positioned underneath the floor runners.

**A6.** Attach **Floor Runners** to completed floor frame. There are 2 floor runners per 136 1/2" side and 5 completed runners in total. Use **6 - 2 1/2" Screws** per Runner.

<u>Parts</u>	<u>Hardware</u>
<b>Floor Runners</b> (1 1/2" x 3 1/2" x 60) x 5 (1 1/2" x 3 1/2" x 76 1/2") x 5	<b>2 1/2" Screws x 60 total</b>

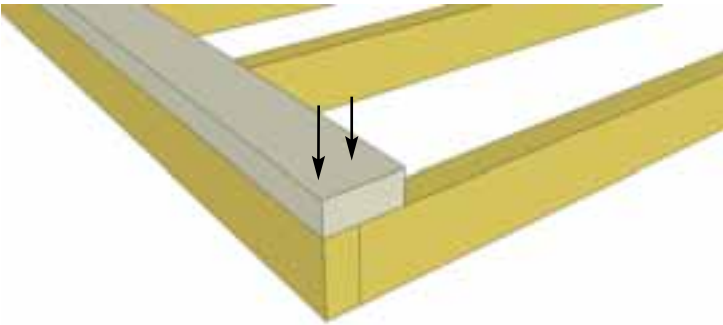

**A7.** Make sure Runners are flush with outside and front and rear floor framing, not overhanging.

**A8.** Complete all Floor Runners.

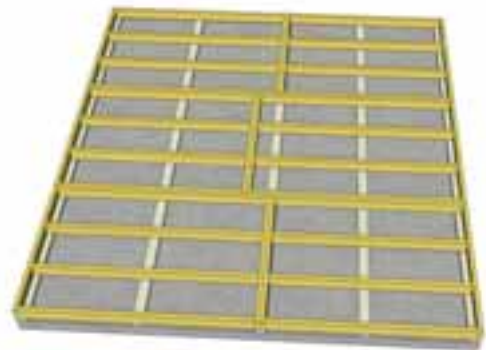
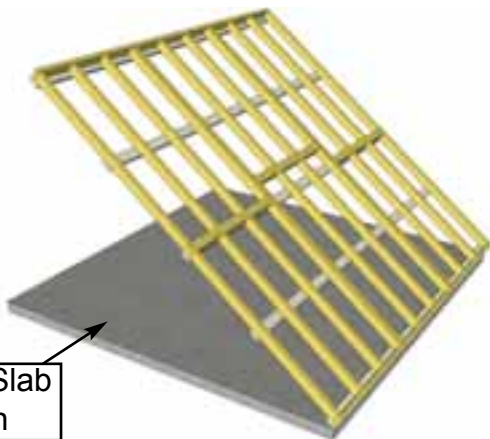

**A9.** With Floor Runners attached, carefully flip the floor over and place on your foundation. **Caution:** you will need 2 people to assist you. Be careful when laying floor down not to bend or twist floor. When in place, level floor completely.

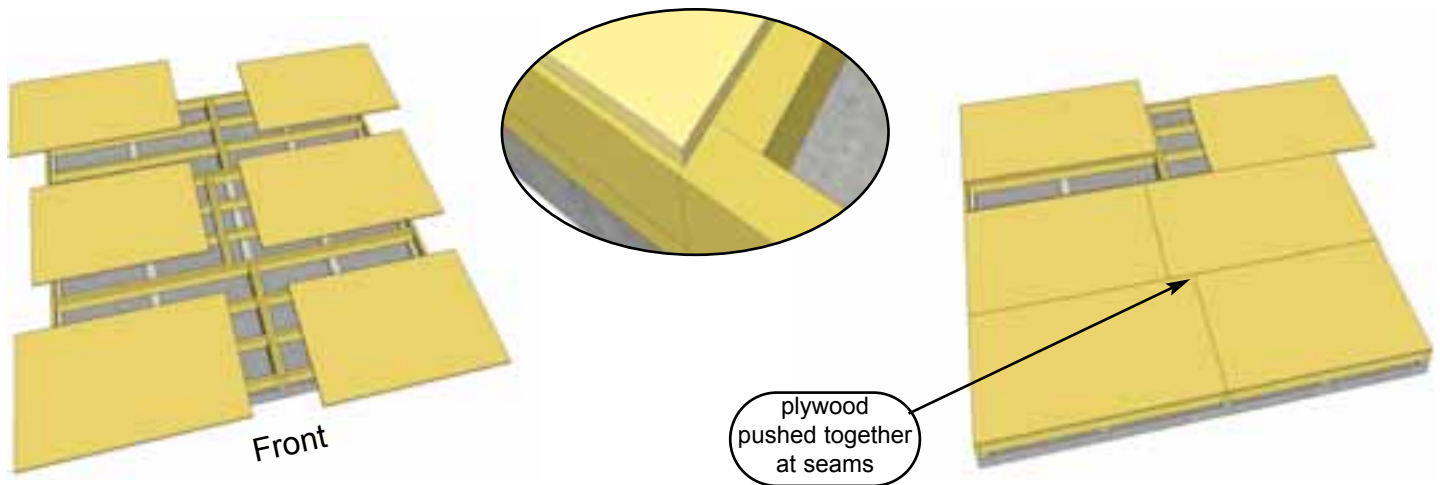

**A10.** Position **Plywood Floor** pieces (6) on top of completed Floor Joists. Plywood will sit slightly back from outside edge of Floor Joist Framing.

<p><u>Parts (Steps A10 - A11)</u>  <b>Plywood Floor - Large</b>          (45 3/8" x 74 7/8") x 3  <b>Plywood Floor - Small</b>          (45 3/8" x 66 3/8") x 3</p>	<p><u>Hardware (Steps A10 - A11)</u>  <b>1 1/4" Screws</b>          x 85 total (approx.)</p>
---	--

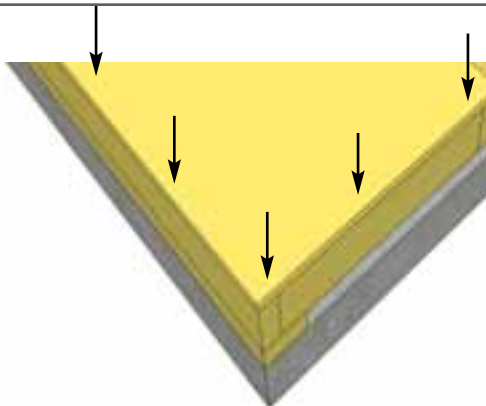

**Hint:** Use a chalk line to mark location of floor joists to determine screw placement.

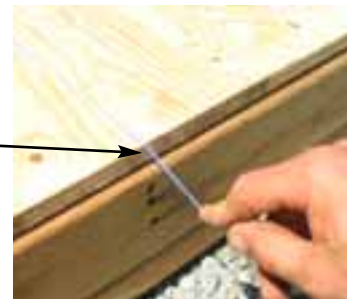

**A11.** With Plywood positioned correctly on floor framing, attach with **1 1/4" Screws**. Use screws every 16" (approximately 85 total). The Plywood is cut slightly smaller than floor framing. Keep plywood seams tight.

**Important:** Check to confirm that your floor is level prior to proceeding to the next step of wall assembly.

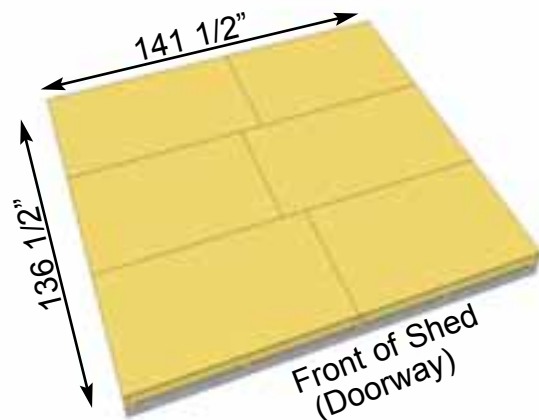

# B. Wall Section

Exploded view of all parts necessary to complete the Wall Section. Identify all parts prior to starting.

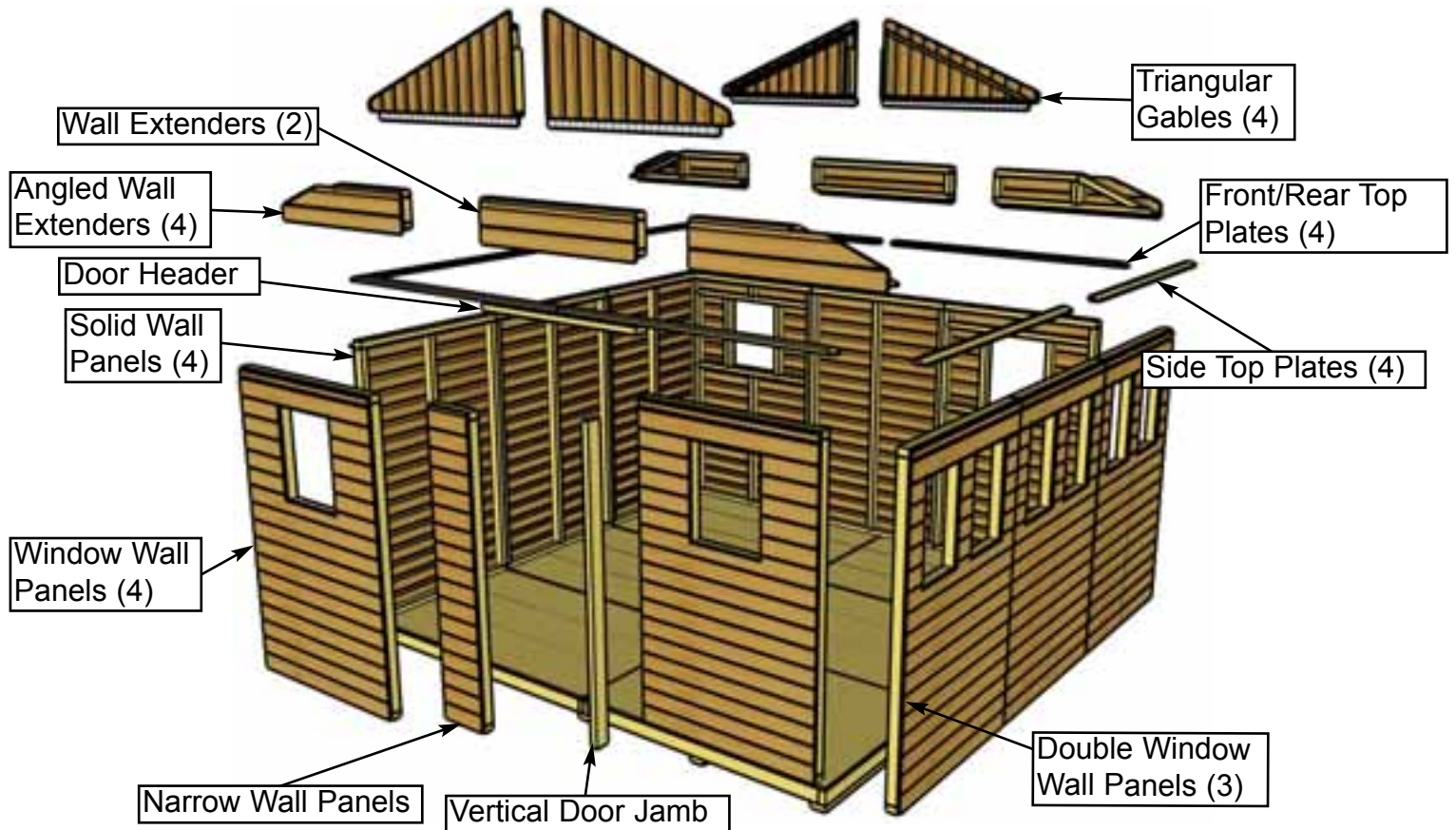

**Important:**  
Pilot hole **ALL** 2x3 Wall Studs with 1/8" drill bit prior to screwing. This will make it much easier to attach together.

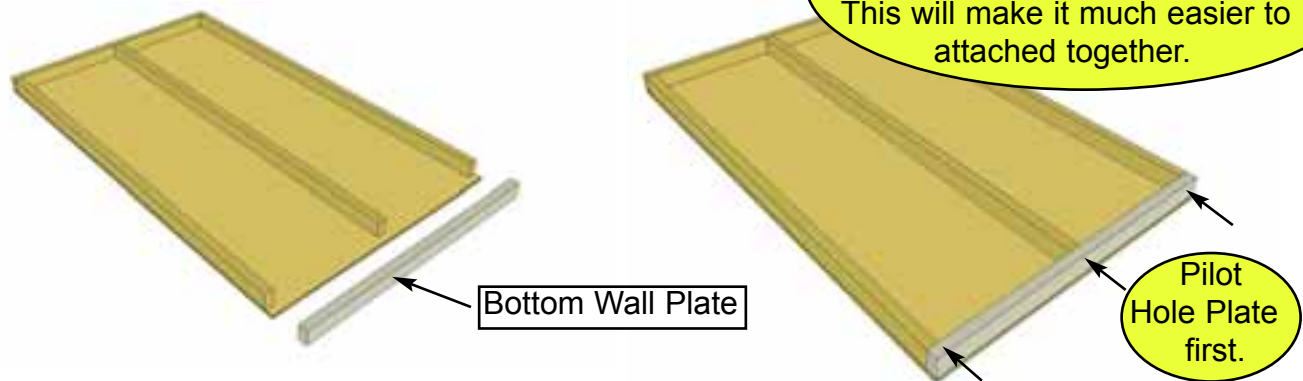

**B1.** Starting with **Solid Wall Panels**, carefully lay panel face down. Position and attach **Wall Plate** to bottom of wall studs of each wall panel with 3 - 2 1/2" Screws. Position so plates are flush with framing. Note: bottom Wall Plates may already be attached to some Solid Walls.

Parts	Hardware
Solid Wall Panels (45 1/2" x 75") x 4	2 1/2" Screws
Bottom Wall Plates (1 1/2" x 2 1/2" x 45 1/2") x 4	x 12 total

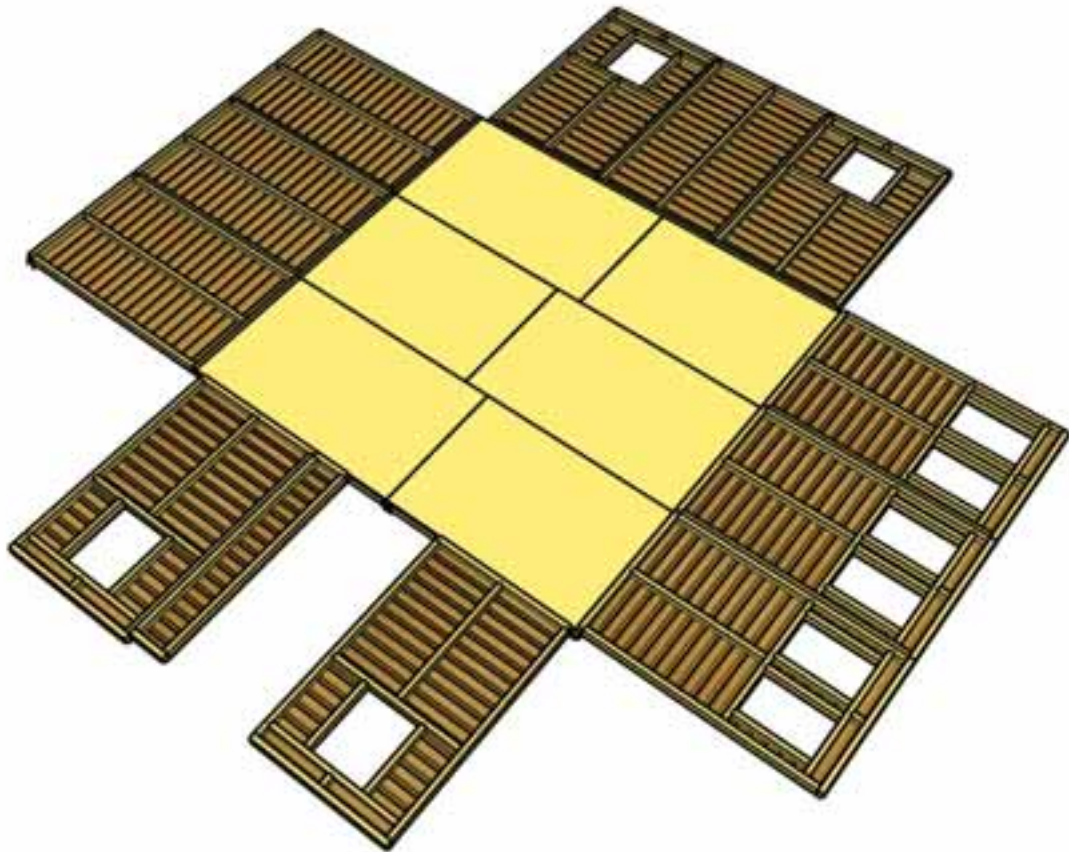

**B2.** Lay out all the Wall Panels and become familiar with their location. On Standard Kits, there are **7 Solid Wall Panels** and **2 Front Wall Panels**. Make sure to position panels right side up so water is directed away from and not into shed. Look at door opening and exposed wide Floor Runner to determine proper wall position to confirm.



**Important:** Make sure all walls are aligned in their upright position. If not, water may leak into your shed. Unsure if panel is facing up or down? check siding on window wall panel to match alignment.

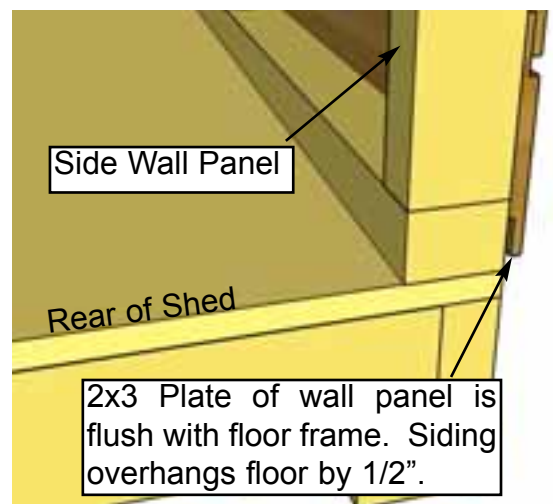

**B3.** Starting at Rear Corner, position a **Solid Wall Panel** on top of plywood floor. Make sure panel is facing up. The side wall panels will sit flush with floor frame with the front and rear panels sandwiched between them. **Note:** siding will overhang the floor by approx. 1/2\"/>

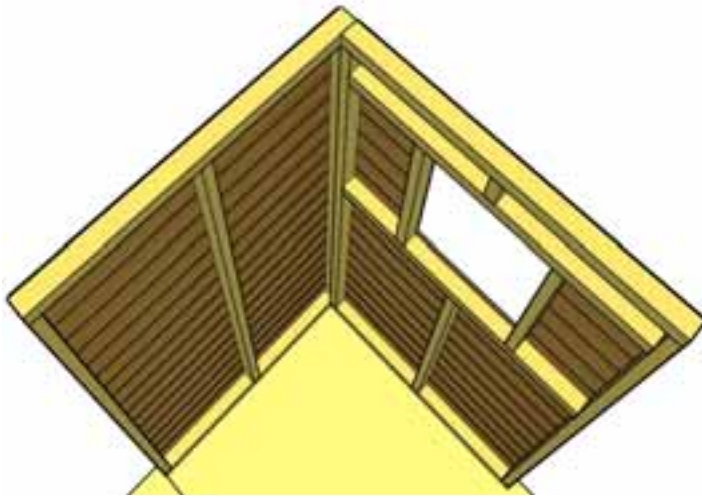

**B4.** Position rear **Window Wall Panel** into place on plywood floor. Butt both vertical wall studs of side and rear walls together and attach with 3 - 2 1/2" Screws. Screw at the bottom, middle and top of stud to secure properly.

<p><u>Parts (Steps B4 - B10)</u>  <b>Window Wall Panels (45 1/2" x 75") x 4</b>  <b>Double Window Wall Panels (45" x 75") x 3</b>  <b>Narrow Wall Panel (12" x 73")</b></p>	<p><u>Hardware (Steps B4 - B10)</u>  <b>2 1/2" Screws</b>  <b>x 33 total</b></p>
---	--

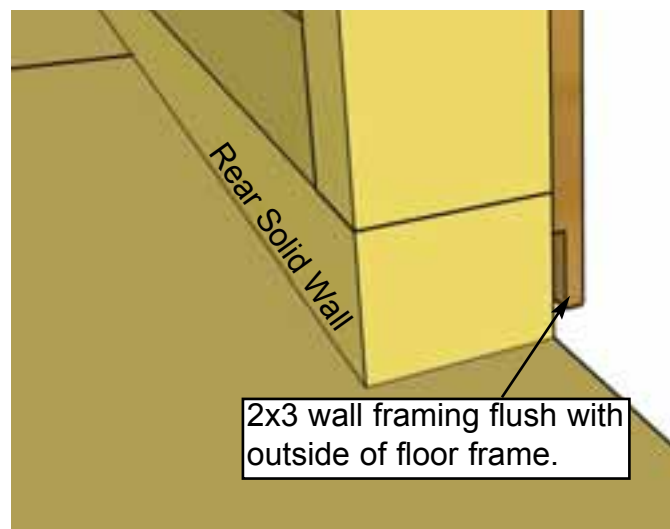

2x3 wall framing flush with outside of floor frame.

**B5.** With the corner wall attachment complete, position a Solid Rear Wall Panel so bottom 2x3 wall framing is sitting flush with outside floor frame. Wall siding should overhang floor by approximately 1/2". Attach rear Wall Panel studs together as per **Step B4**.

**Do Not Attach Walls To Floor until Step B15.**



**B6.** Position the final Rear Panel on the floor (Window Wall Panel). Position vertical wall studs together and attach as per **Step B4**.

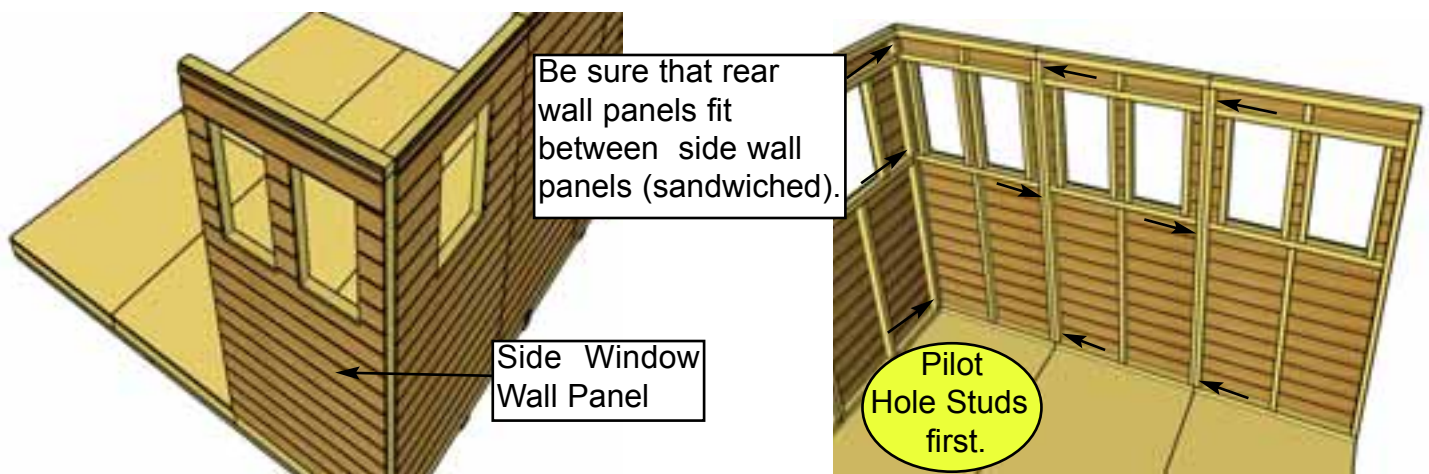

**B7.** Attach a Side Window Wall Panel (2 windows in panel) in corner. Attach as per **Step B4**. Start positioning and securing remaining Side Window Wall Panels on your floor. Attach wall studs together as per **Step B4**.

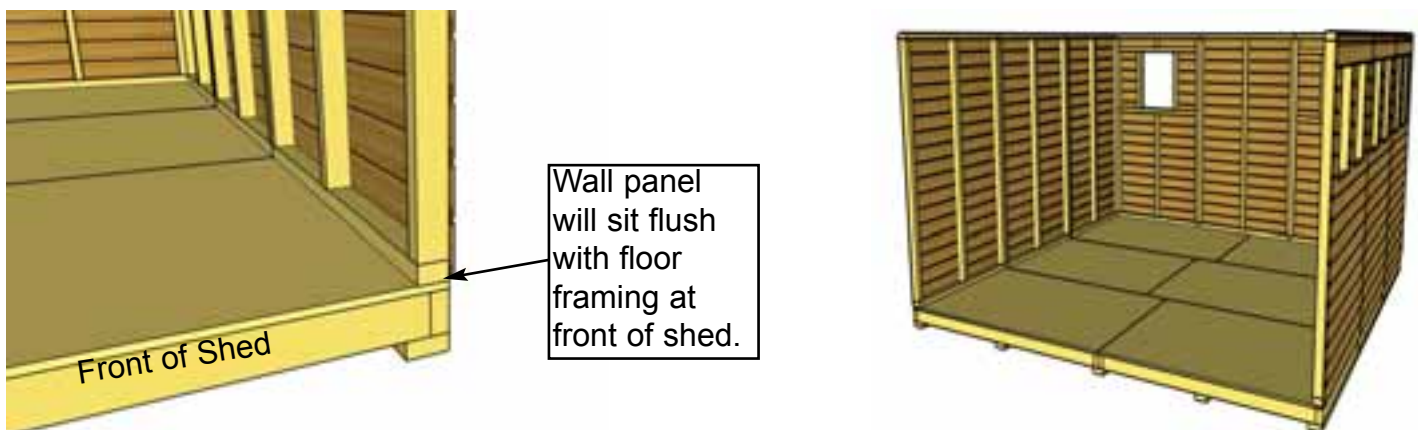

**B8.** Complete attachment of left Side Wall Panels. At the front of the shed, side walls will sit flush with front of floor framing.

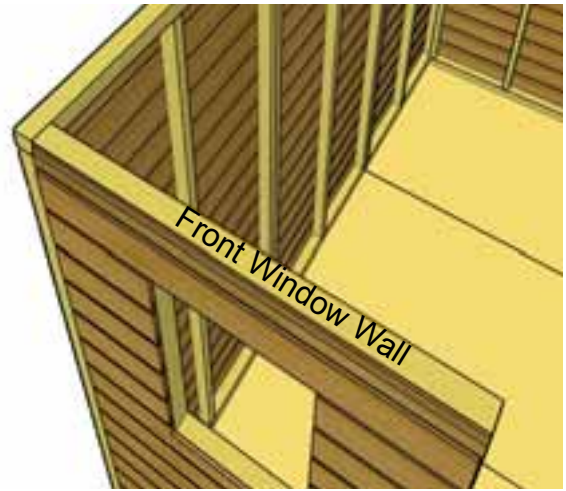
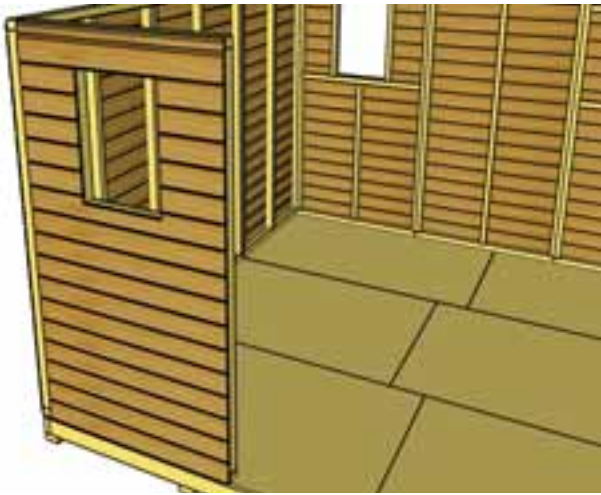

**B9.** In the Front Corner, attach a Window Wall Panel. Line wall studs up as per Step B7 and secure together.



Narrow Wall Panel (can go on left or right side).



**B10.** Secure 2nd Front Corner Window Wall Panel. Place Narrow Wall Panel adjacent to either left or right Window Wall - your choice.



**B11.** Line up Window Wall and Narrow Wall so flush with each other on the outside. Attach studs together with 3 - 2 1/2" Screws as per Step B4. Note: Narrow Wall is 73" high (2" shorter than Window Wall).



Jamb sits flush with Wall framing

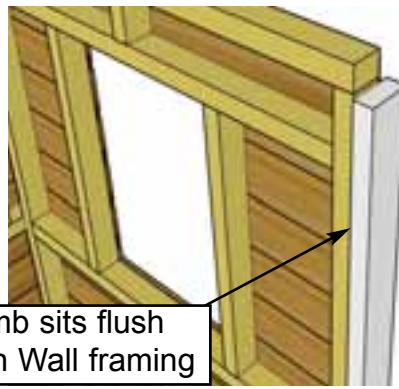

Jamb will have 3/8" of overhang

**B12.** Locate **Vertical Door Jamb** and position flush against right wall panel stud. The Jamb is 3 1/4" wide and have 3/8" overhang from wall siding. When positioned correctly, secure Jamb using 4 - 2 1/2" Screws.

<u>Parts</u> <b>Vertical Door Jamb</b> (1 1/2" x 3 1/4" x 73")	<u>Hardware</u> <b>2 1/2" Screws</b> x 4 total
--	--

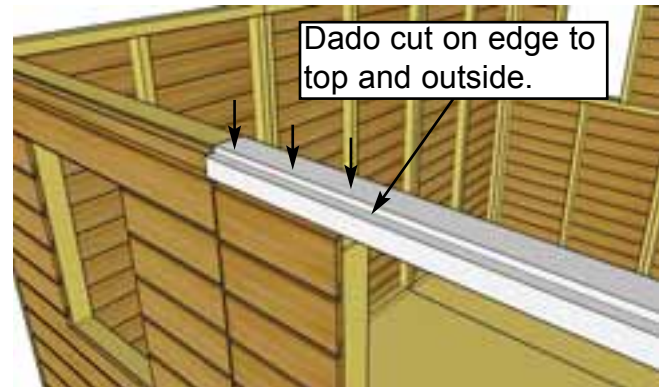

Dado cut on edge to top and outside.

**B13.** Position and attach the **Door Header** to Door Jamb and Narrow Wall Panel top framing. Header should sit flush with Door Jamb and Outside of Narrow Wall Siding. Attach with 4 - 2 1/2" Screws.

<u>Parts</u> <b>Door Header (Dado)</b> (2" x 3 1/4" x 45 1/2")	<u>Hardware</u> <b>2 1/2" Screws</b> x 4 total
--	--

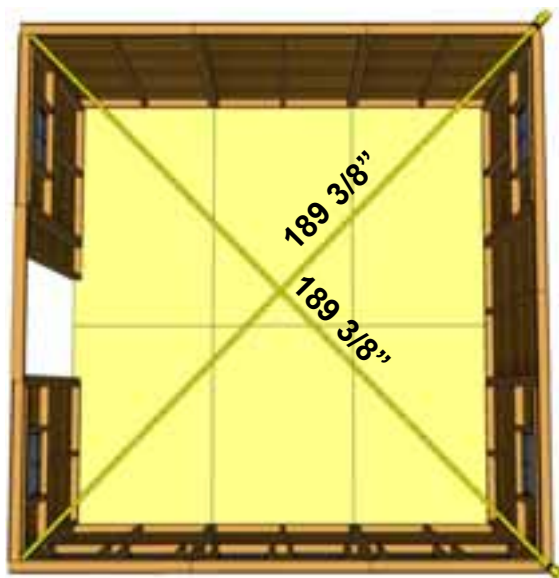

**Advice:** Prior to fastening walls and installing rafters, take time to confirm your walls are level, square and plumb.

Measure diagonal at top and bottom of walls corner-to-corner. This should be approximately 189 3/8". More importantly, if measurements are not within 1/4", your walls are not square. Adjusting now will make it easier to the roof section later.

**Important:** If walls are not lining up and appear higher or lower than each other, please check the level of your floor. You may need to make slight adjustments before proceeding.

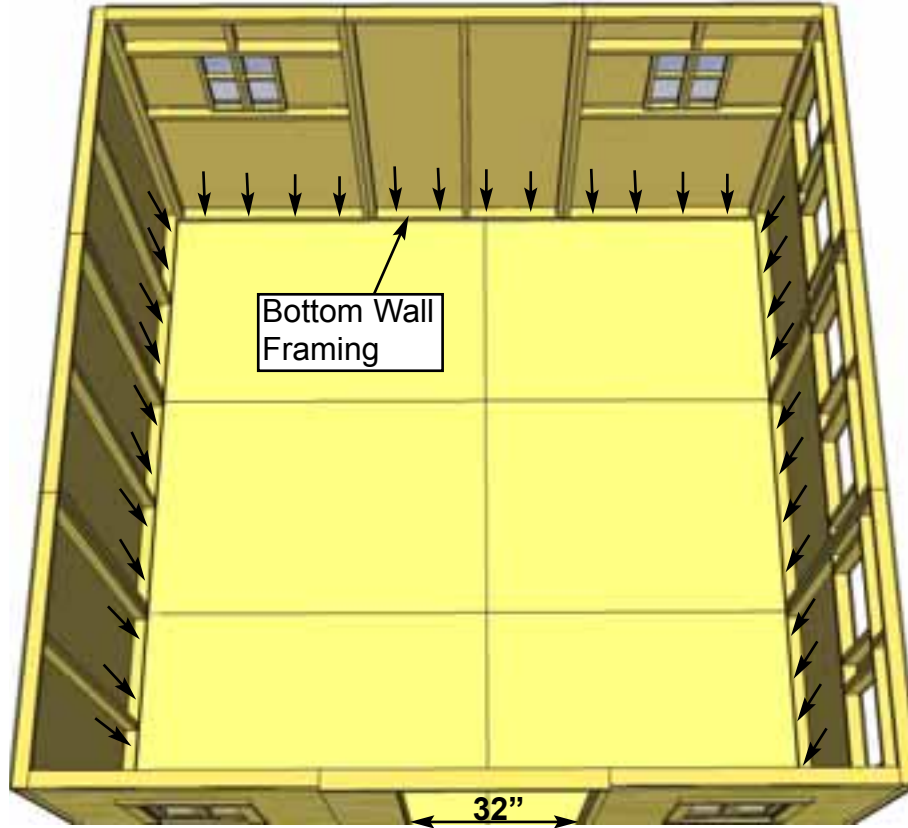

Angle screws into perimeter Floor Joists.

**Optional:** Caulking seams will help prevent moisture from entering your shed. Caulking is included to complete polygal Windows only. Additional Caulking may be required.



**B14.** When all walls are attached together, check alignment with the floor. Bottom wall framing should sit flush with outside of floor joists. When positioned correctly, fasten bottom wall plates to floor using 4 - 2 1/2" Screws per wall panel and 2 - 2 1/2" Screws for Narrow Wall panel Confirm 32" wide door opening at bottom.

Hardware  
2 1/2" Screws  
x 46 total

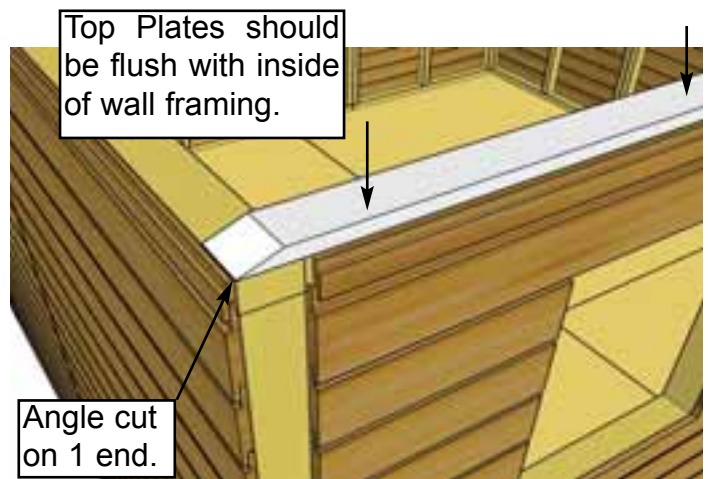
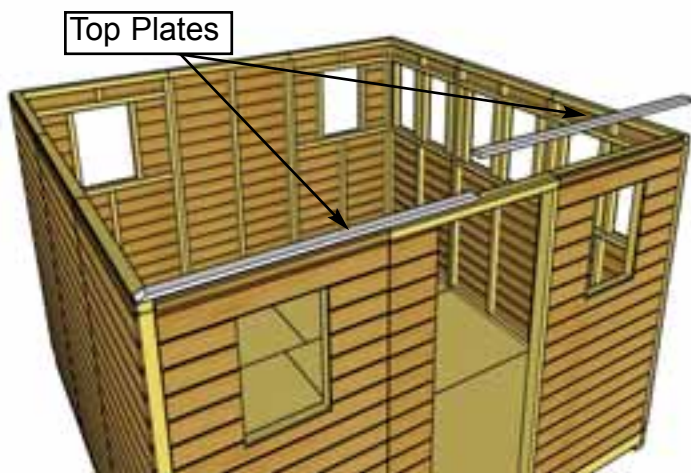

**B15.** Position **Front Top Plates** on top of wall framing so they are flush on the inside with 2x3 wall frame. There are 2 Front Top Plates. Together, the plates should be centered evenly on the wall left to right. Attach by screwing down into top wall framing with 4 - 2" Screws per Plate.

Parts (Steps B15 - B17)

**Front & Rear Top Plates** - Angle Cut Edge  
 (3/4" x 2 1/2" x 70 3/4") x 4

**Side Top Plates** - 22 1/2 Degree Cut on Edge  
 (3/4" x 2 1/2" x 65 3/4") x 4

Hardware (Steps B15 - B17)

**2" Screws**  
 x 32 total

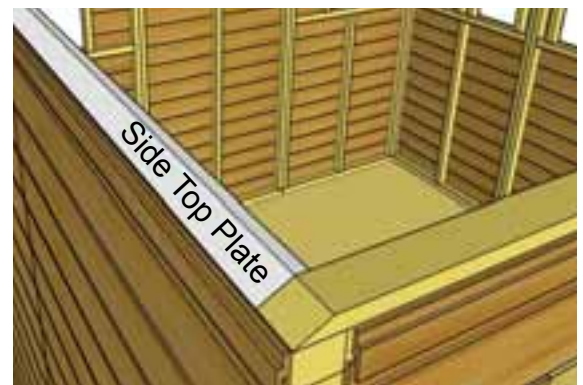
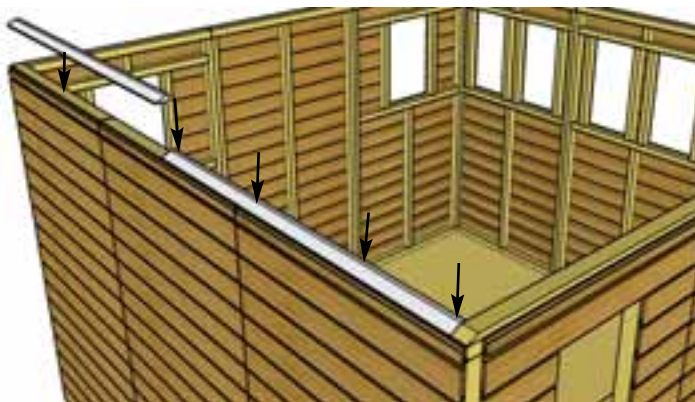

**B16.** Next, attach the 2 **Side Top Plates**. The Side Top Plates are angle cut down the length. Once again, position Top Plate on wall plate so it is flush with inside of wall plate. Side Top Plate should also be flush with Front Top Plate. Secure with 4 - 2" Screws per piece.

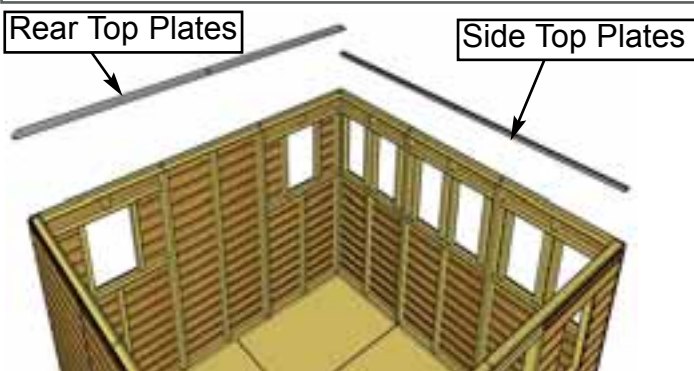

**B17.** Position remaining Rear and Side Top Plates on wall top framing to complete. Use 4 - 2" Screws per piece.

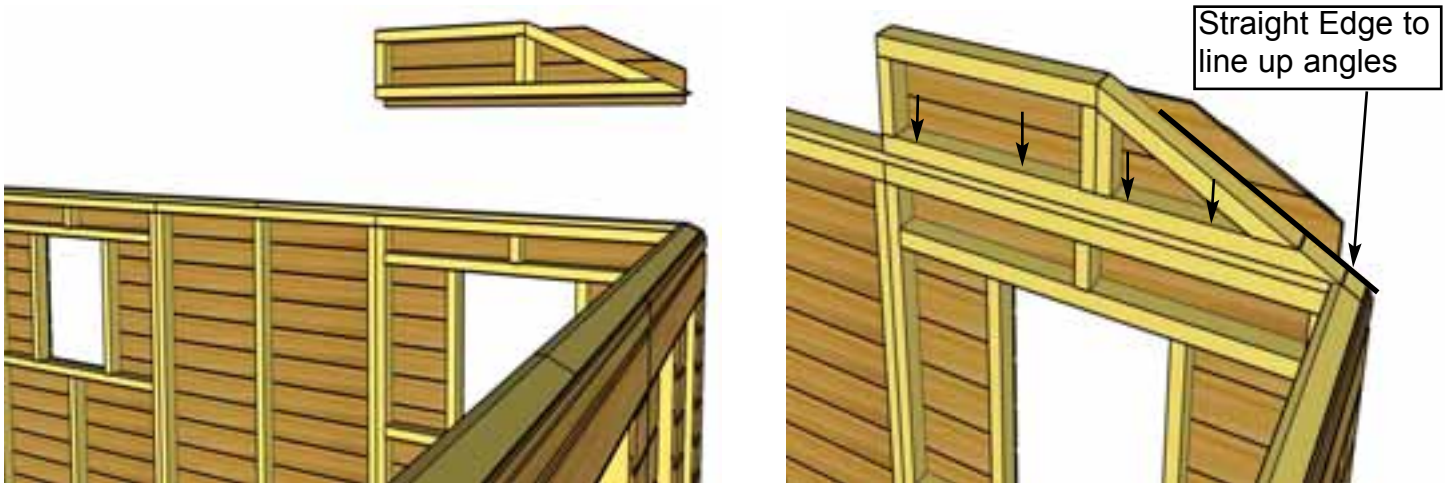

**B18.** Locate and place an **Angled Wall Extender** on Rear Wall Top Plate. Position so Top Plate and Extender Wall angles line up and are flush with each other. When in place, secure with **4 - 2 1/2" Screws**.

Parts (Steps B18 - B20)

**Angled Left & Right Wall Extenders**  
 (46 1/4" x 9") x 4  
**Wall Extenders**  
 (45 1/2" x 9") x 2

Hardware (Steps B18 - B20)

**2 1/2" Screws**  
 x 32 total

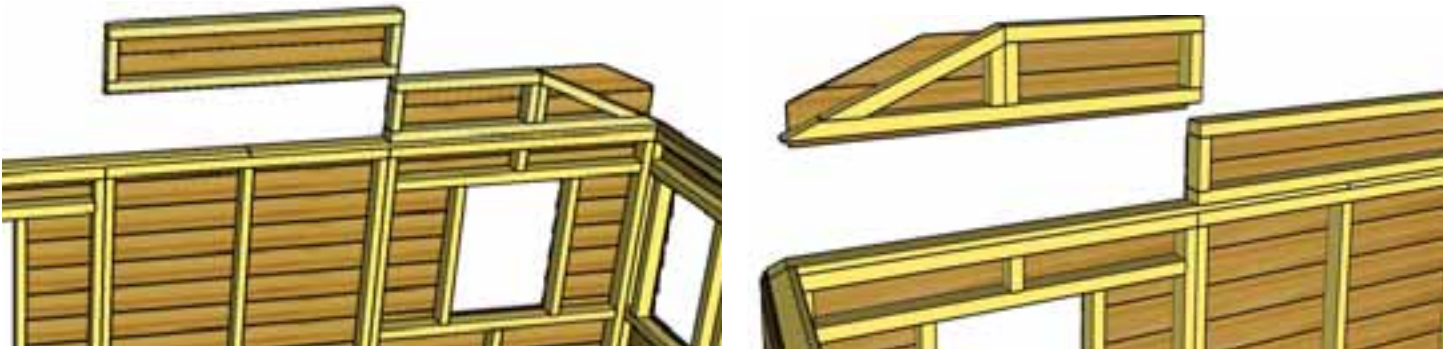

**B19.** Locate and place the **Middle Wall Extender** on Top Plate and flush with Angled Extender Wall framing. When correctly in place, secure with **4 - 2 1/2" Screws**. Complete remaining Angled Wall Extender attachment. Use **4 - 2 1/2" Screws** to connect Middle Wall to Angled Extender Walls. See **Step B21**.

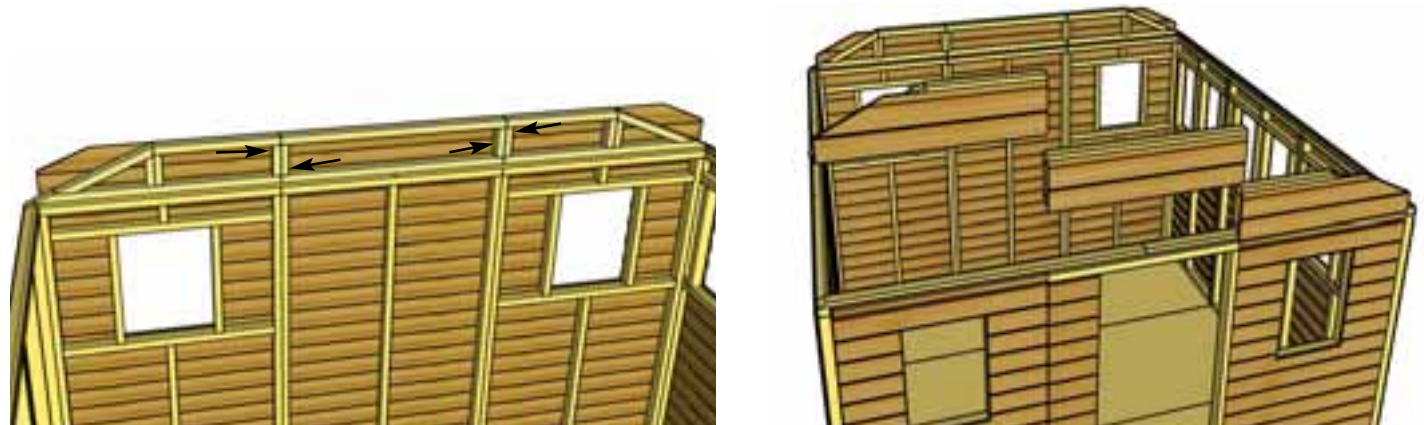

**B20.** After completion of Rear Wall Extenders, complete the front wall Extenders following Steps B18 - B19.

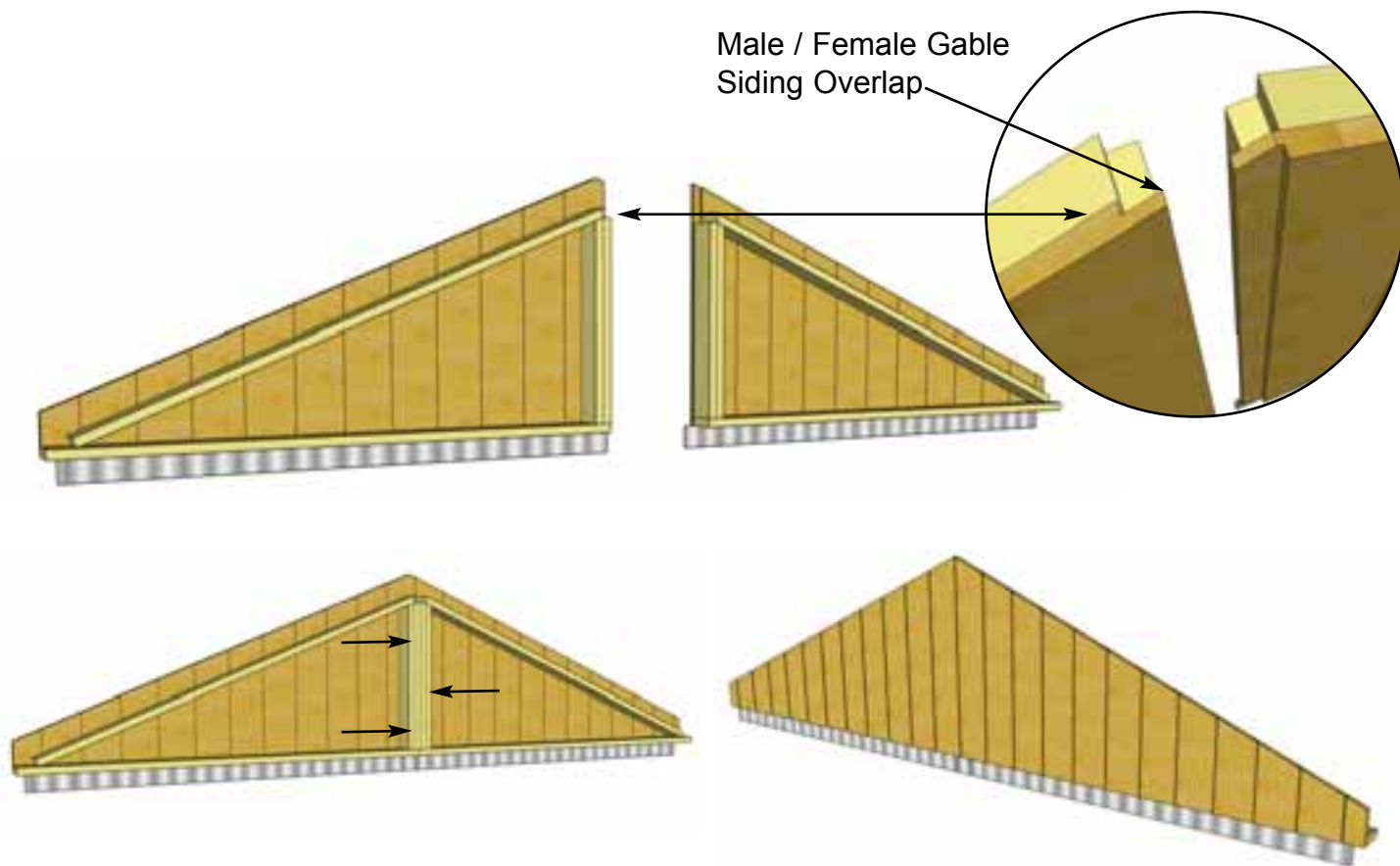

**B21.** Locate **Triangular Gable Half Walls** for both sides of the shed. Align framing with siding overlapping, and screw center wall framing of each piece together with 3 - 2 1/2" Screws. **Note:** prior to attaching, try each combination of Gables for best fit.

<p><u>Parts (Steps B21 - B23)</u>  <b>Triangular Gable Half Walls x 4</b></p>	<p><u>Hardware (Steps B21 - B23)</u>  <b>2 1/2" Screws x 6 total</b>  <b>2" Screws x 8 total</b></p>
---	--

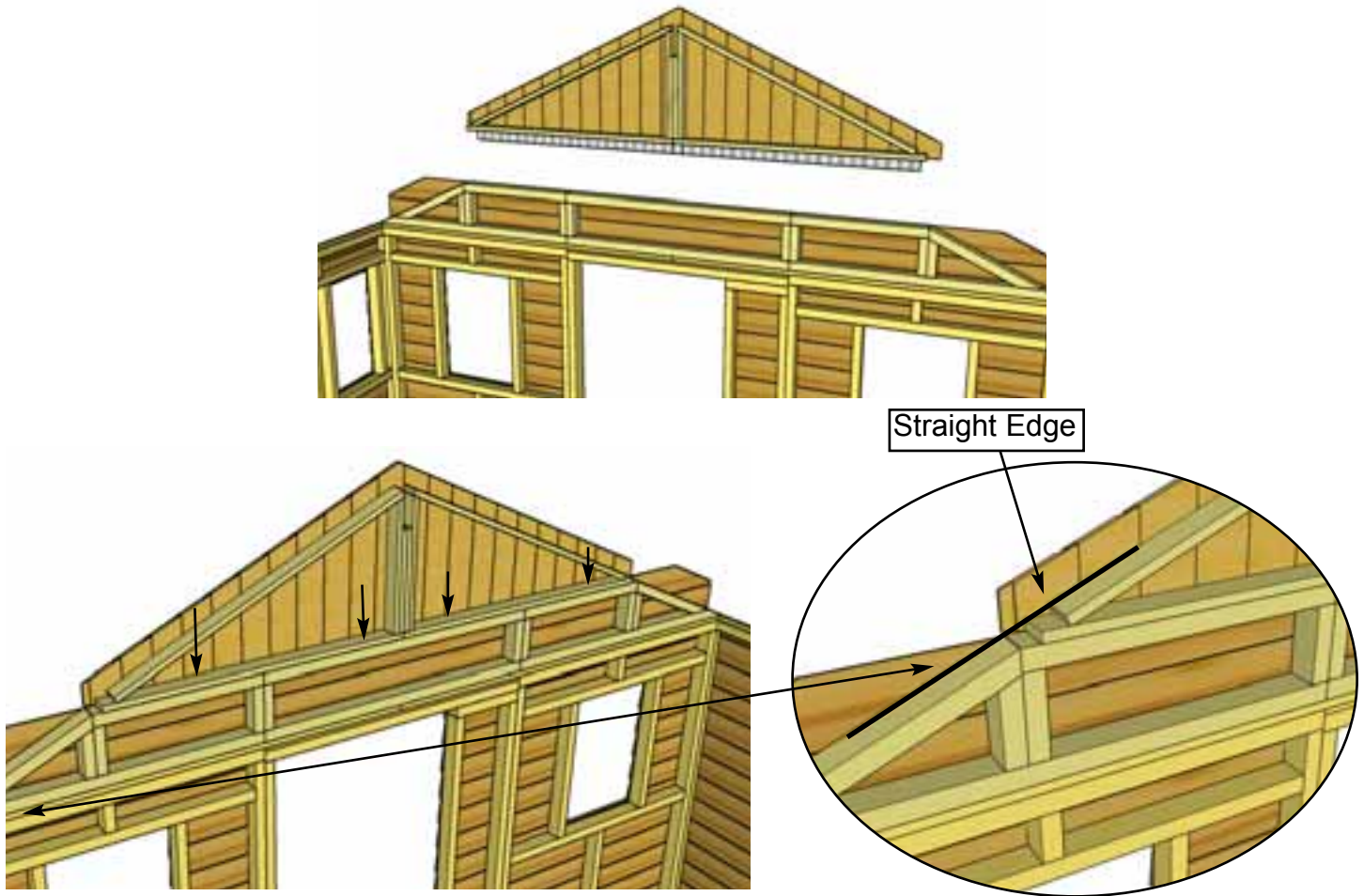

**B22.** Lift completed Gable Section up and place on top of front Wall Extenders. Move Gable Section framing left to right to line up with Wall Extender framing. Use a straight edge to check for correct alignment. When in place, tack down Gable framing for now with 4 - 2" Screws.  
**Note:** Gable alignment may need to be adjusted after Rafters are installed.



**B23.** Lift, align and attach Rear Gable Section as per Step B22.

# C. Rafter Section

Exploded view of all parts necessary to complete the Rafter Section. Identify all parts prior to starting.

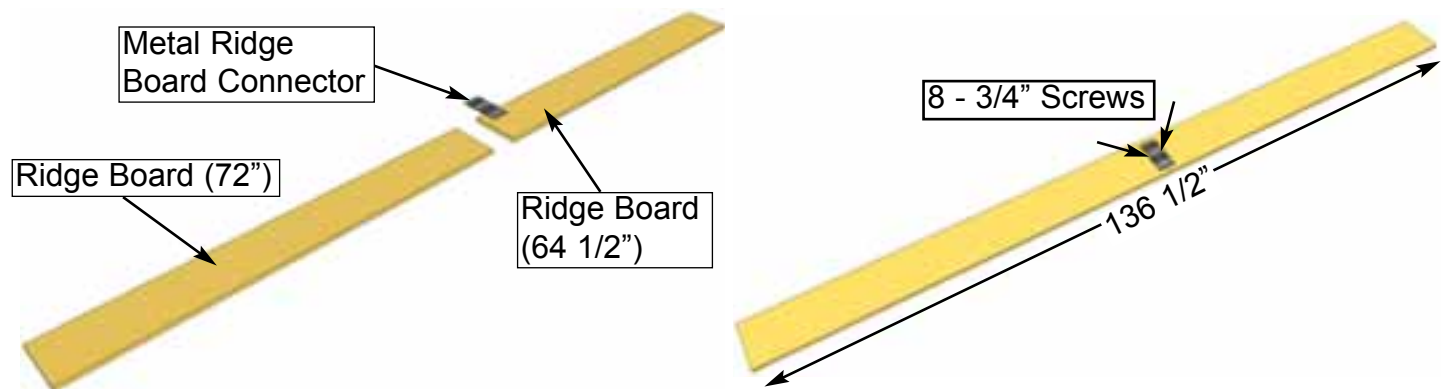
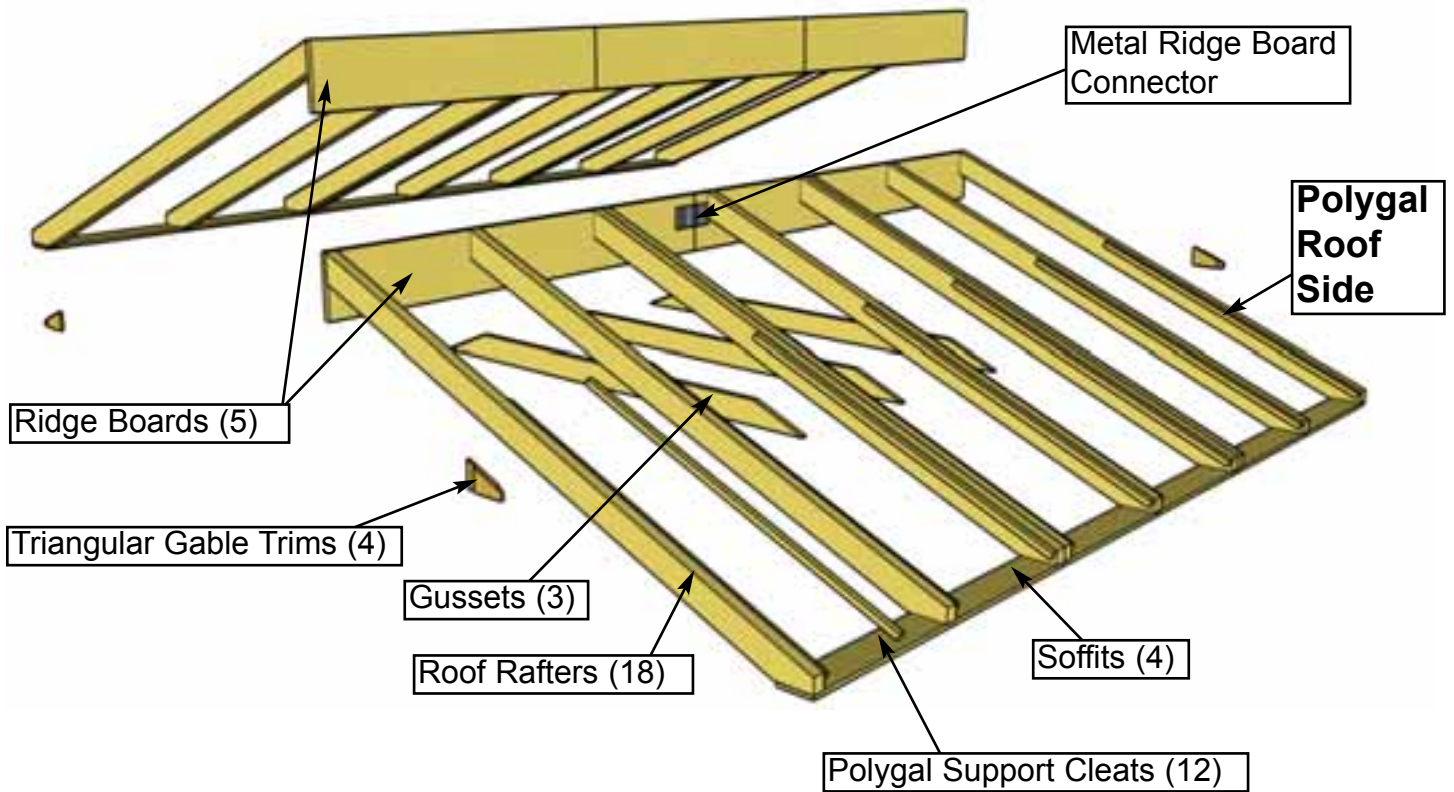

**C1.** Locate 72" & 64 1/2" Ridge Boards and attach together with Metal Ridge Board Connector using 8 - 3/4" Screws evenly on boards. Total Length when connected is 136 1/2".

Parts	Hardware
<b>Ridge Boards</b> (3/4" x 8 1/2" x 72") (3/4" x 8 1/2" x 64 1/2")	<b>3/4" Screws</b> x 8 total

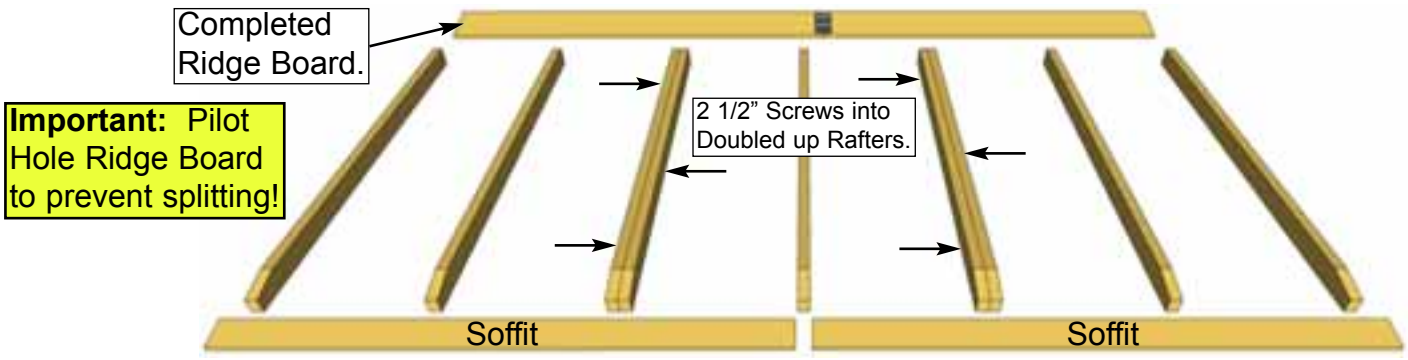

**C2.** Lay out 9 Rafters, 2 Soffits and the completed Ridge Board from Step C1 on level ground as shown. Double up Rafters as illustrated. Screw doubled up Rafters together with 3 - 2 1/2" Screws. **Note:** completed rafter section will be flipped over in Step C5.

Parts (Steps C2 - C5 )	Hardware (Steps C2 - C5 )
Rafters (1 1/2" x 3 1/2" x 56 1/2") x 18	2 1/2" Screws x 12 total
Soffits (1" x 4 1/2" x 68 1/4") x 4	2" Screws x 36 total
Ridge Boards (3/4" x 8 1/2" x 45 1/2") x 3	1 1/4" Screws x 36 total

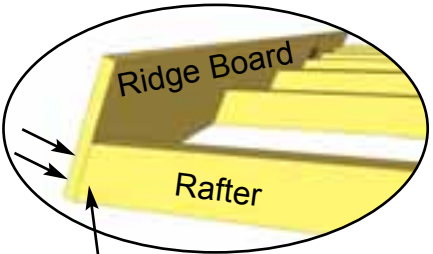

**C3.** Attach completed Ridge Board to ends of both outside rafters with 2 - 2" Screws per end. Measure and position interior Rafters as illustrated above. When positioned correctly, attach Ridge Board to remaining rafters with 2 - 2" Screws per rafter end.

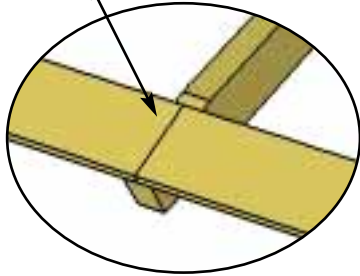
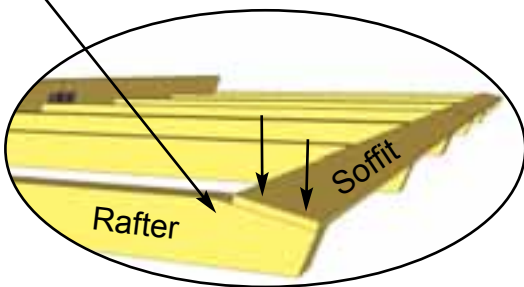
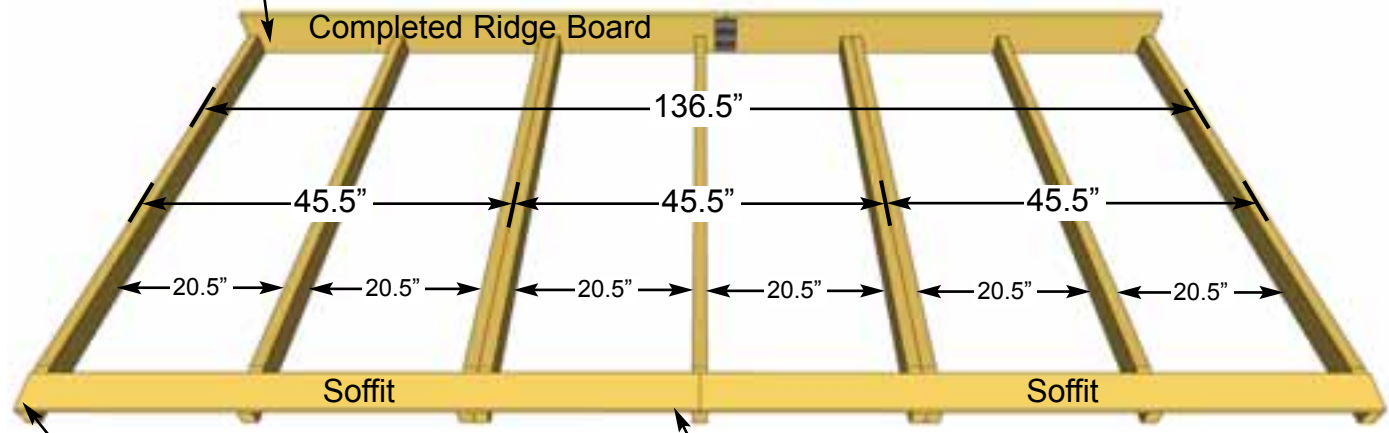

**Important:** Measure 20 1/2" spacing accurately to accommodate Polygal Panels. **See Step 66.**  
**Expert Advice:** Use Polygal panel to confirm correct width.

**C4.** Attach end of a 68 1/4" long Soffit Board flush to ends of outside rafters with 2 - 1 1/4" Screws per rafter end. Complete both outside Rafter/Soffit connections first. Measure and position interior Rafters as illustrated above. When positioned correctly, attach Soffits to remaining rafters with 2 - 1 1/4" Screws per rafter.

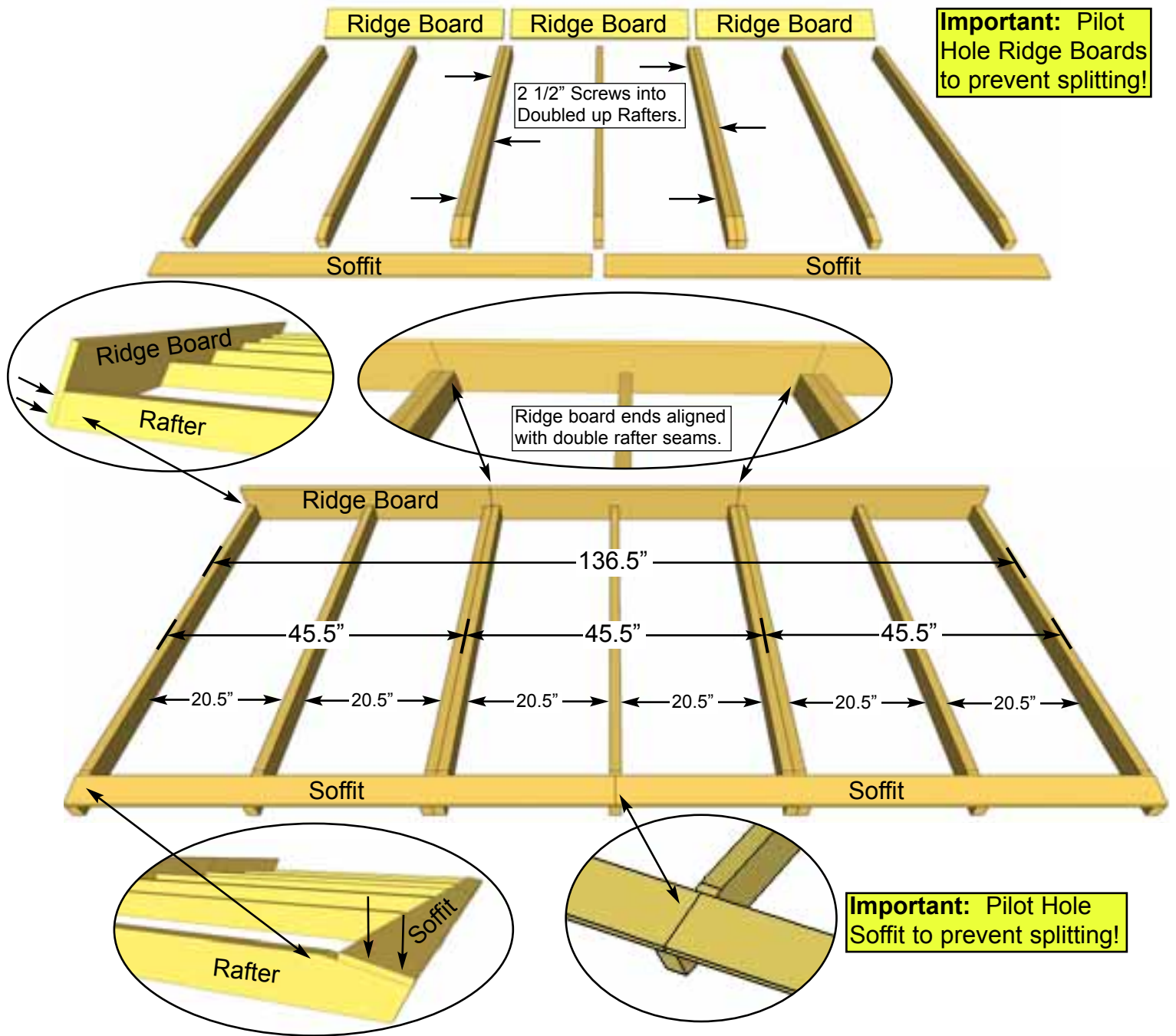

**C5.** Lay out remaining 9 Rafters, 2 Soffits and 3 - 45 1/2" Ridge Boards on level ground as shown. Complete 2nd Rafter section now as per Steps C2 - C4. Note: This Rafter section has three Ridge Boards.

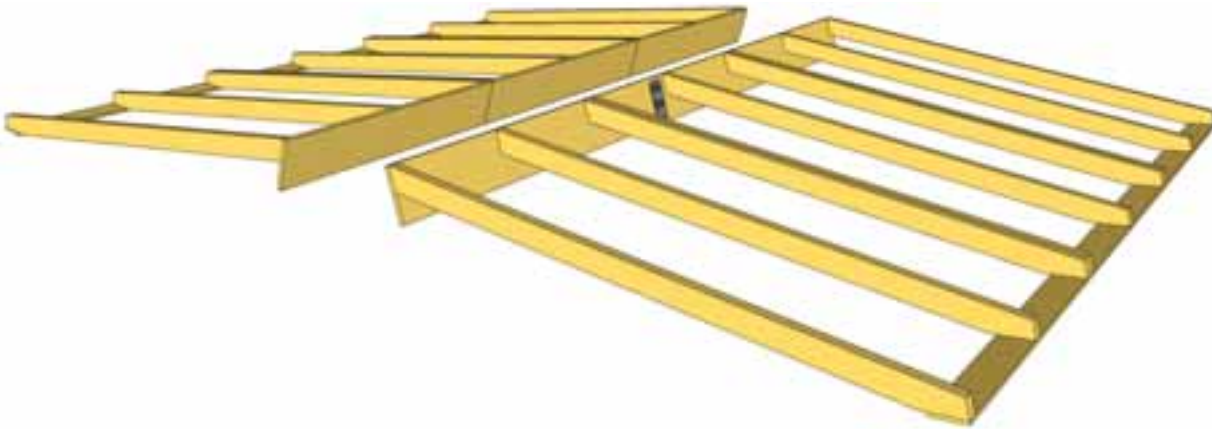

**C6.** Flip both completed Rafter sections over and prepare to lift each section onto wall/gable frame.

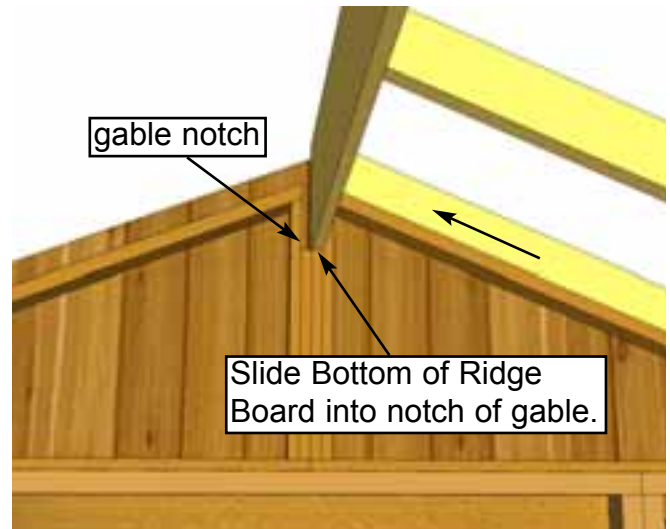

**C7.** With the assistance of two helpers, slide first Rafter Section up onto gable framing until bottom of Ridge Board slips into gable notch. Position rafters so they sit evenly on Gable framing from side to side.

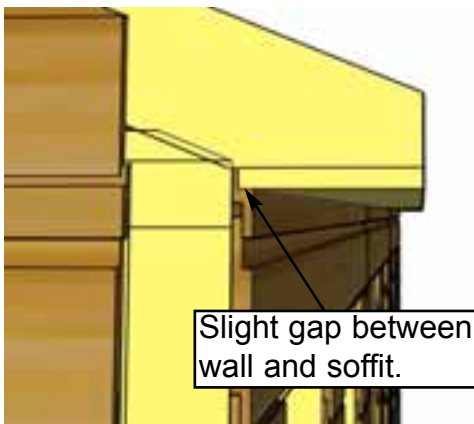

**C8.** Where Wall and Soffit meet, a small gap may appear. Confirm all Rafters are resting on Top Plate.

**C9.** Lift second Rafter Section up and place on Gable framing. Slide Rafter Section up on framing until bottom of Ridge Board slips into Gable notch. Soffit will sit approximately 1/8" away from wall as per Step C8.

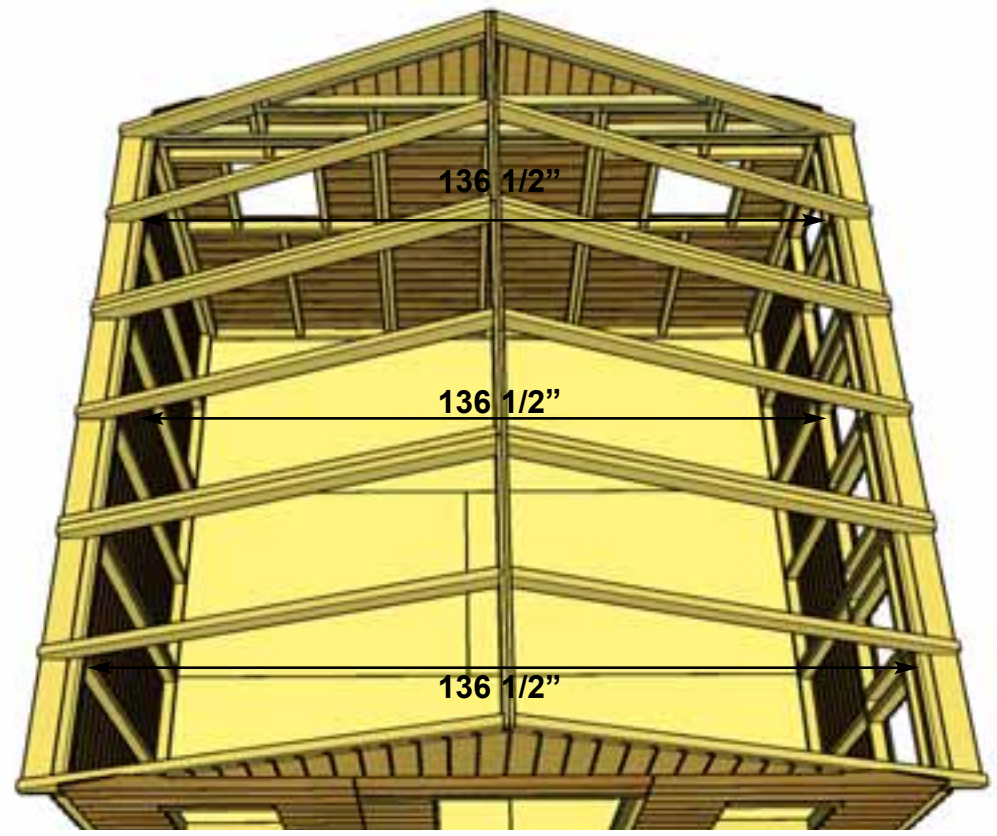
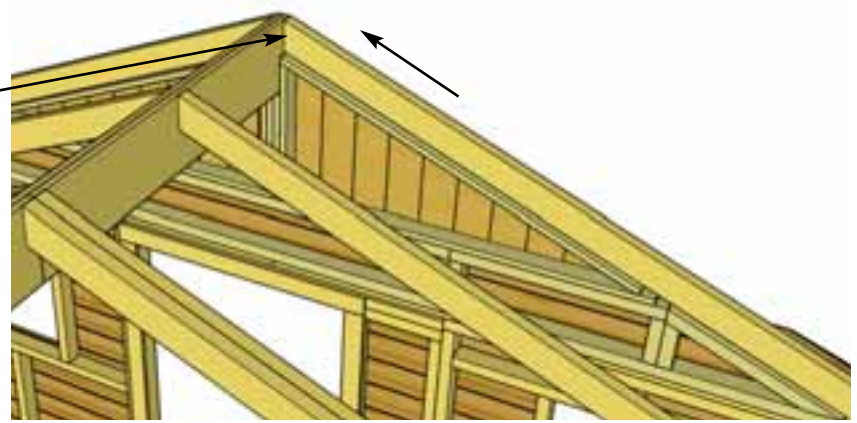
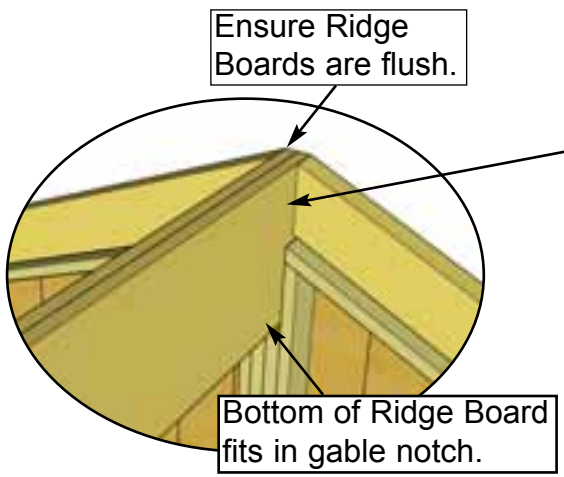
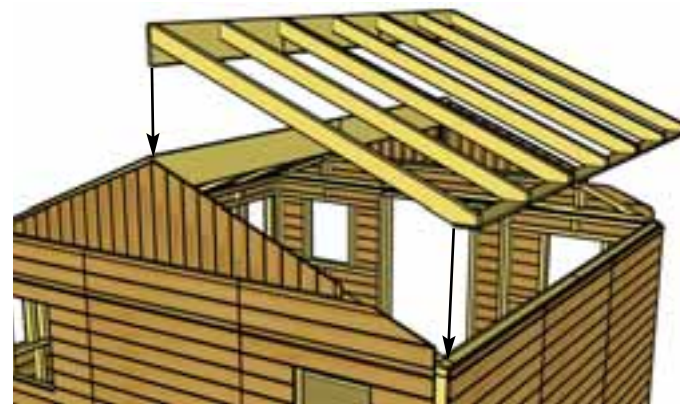

**C10.** Take the inside-to-inside measurement between Top Wall Plates and Bottom Wall Plates at the front, middle, and rear of your shed. These measurements should each be approximately 136 1/2", but more importantly, if they are not within 1/4" of each other, your walls are not square.

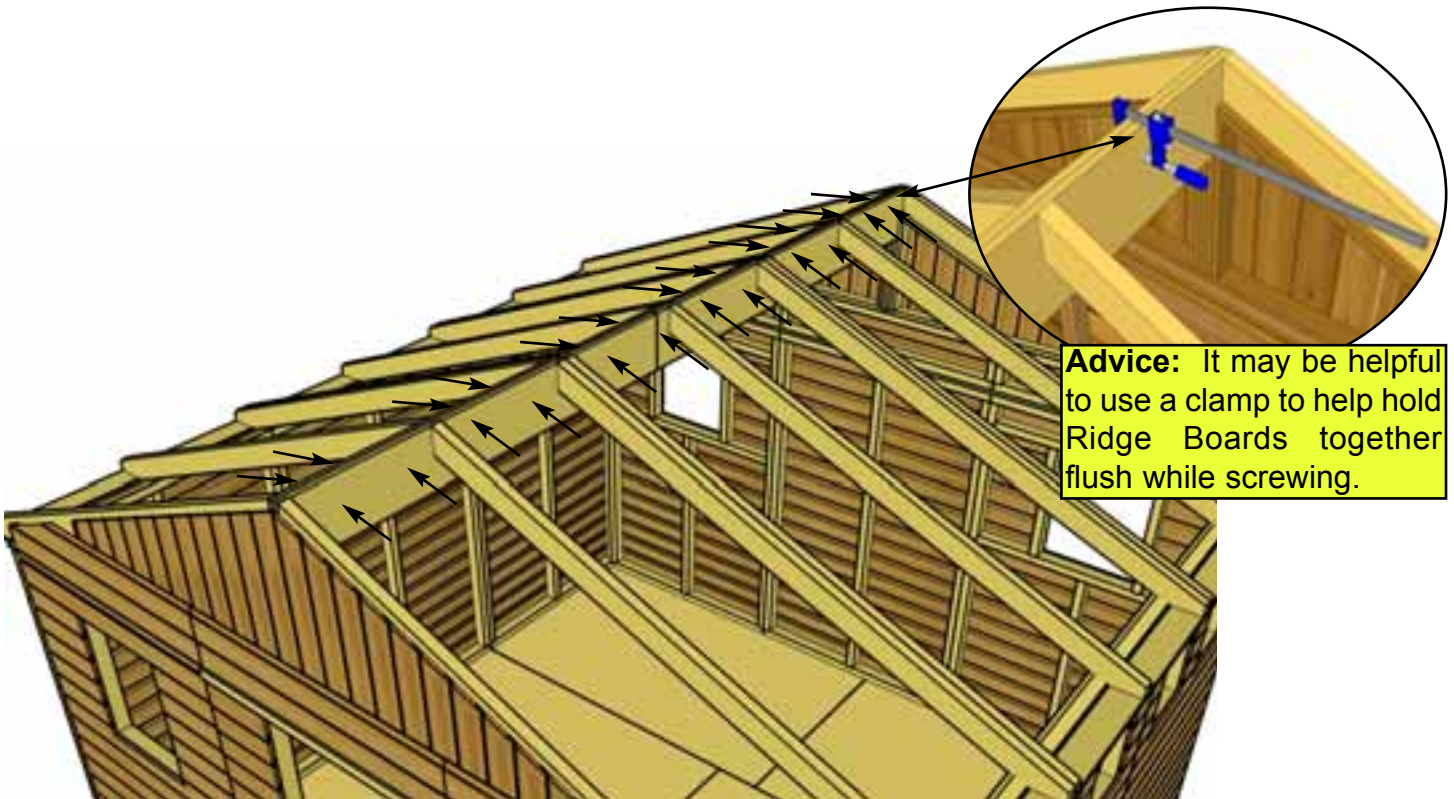

**Advice:** It may be helpful to use a clamp to help hold Ridge Boards together flush while screwing.

**C11.** Where Ridge Boards meet, press together and secure with 12 - 1 1/4" Screws per side. We recommend using a clamp to hold the Ridge Boards together flush while screwing. Stagger screw position vertically on Ridge Board to create a stronger connection. Complete both sides. **Important:** if there is a gap between Ridge Boards, try pushing side walls closer together from outside. Walls should be 136 1/2" apart at top from inside of wall plate to wall plate as per **Step C10**.

Hardware  
1 1/4" Screws  
x 24 total

**Important:** If Gable framing does not line up with Rafters, remove temporary 2" screws from gable framing. Re-align gable and secure with 8 - 2" screws total.



**C12.** With both Rafters Sections correctly aligned, secure Gable framing to both outside rafters with 8 - 2" Screws per side at top and with additional 6 - 2" Screws into wall top plates at bottom.

Hardware  
2" Screws  
x 28 total

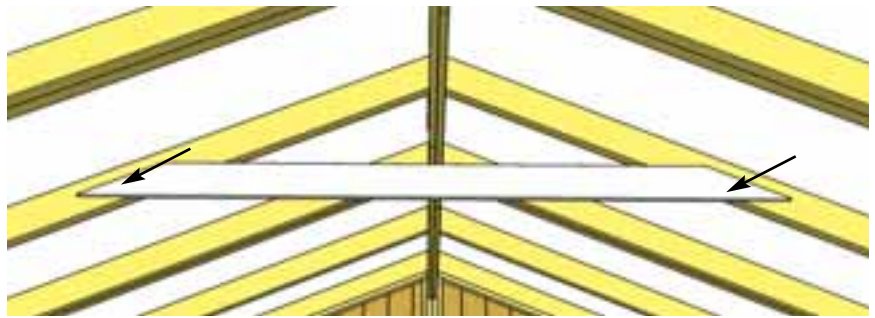
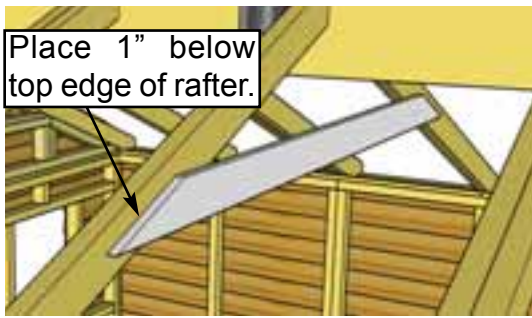

**C13.** Start by attaching one **Gusset** onto the middle rafters as illustrated. Attach only **1 - 2" Screw** per side for now. Before attaching the rest of the Gussets, recheck the inside-to-inside wall measurements as done in **Step C10**. Use a level to check for square. **Important: Pilot hole ends of Gusset to prevent splitting.**

<u>Parts (Steps C13 - C14)</u> <b>Gussets</b> (3/4" x 3 1/2" x 72") x 3	<u>Hardware (Steps C13 - C14)</u> <b>2" Screws</b> x 18 total
---	---

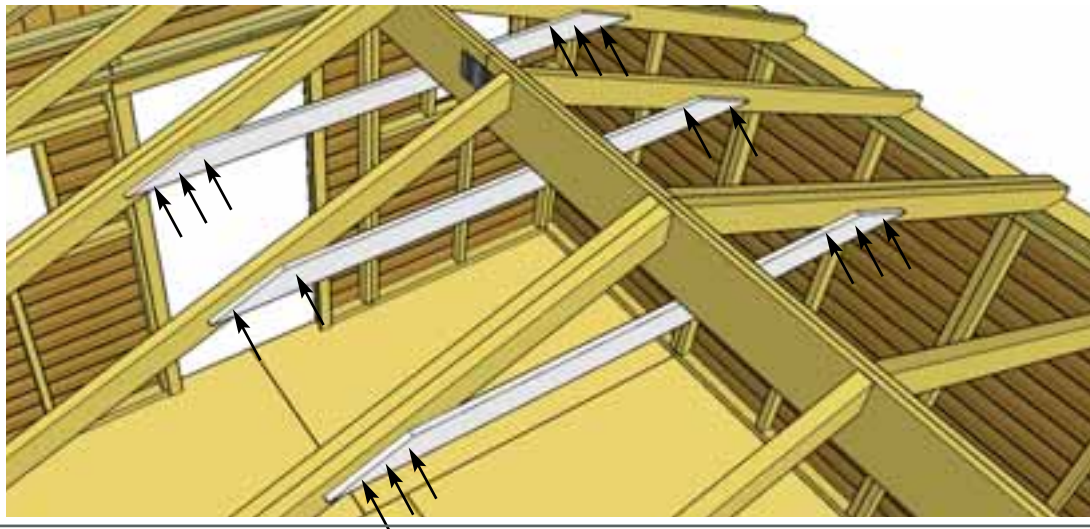

**C14.** Once walls are confirmed to be square and plumb, attach the remaining **2 Gussets** with **3 - 2" Screws** into each end. Attach **2 - 2" Screws** into each end of the middle Gusset which was partially attached in **Step C12**. **Important: Pilot hole ends of Gusset to prevent splitting.**

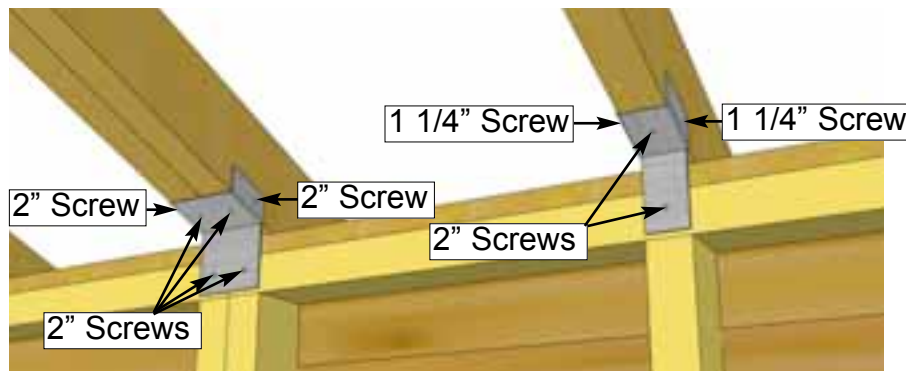

**C15.** Attach all **Single and Double Rafter Brackets** where rafters meet **Top Wall Plates** inside of shed. Attach with **2 - 1 1/4" Screws** and **2 - 2" Screws** per **Single Rafter Bracket** and **6 - 2" Screws** per **Double Rafter Bracket**.

<u>Hardware</u> <b>1 1/4" Screws</b> x 12 total <b>2" Screws</b> x 36 total <b>Single Rafter Brackets</b> x 6 total <b>Double Rafter Brackets</b> x 4 total
---

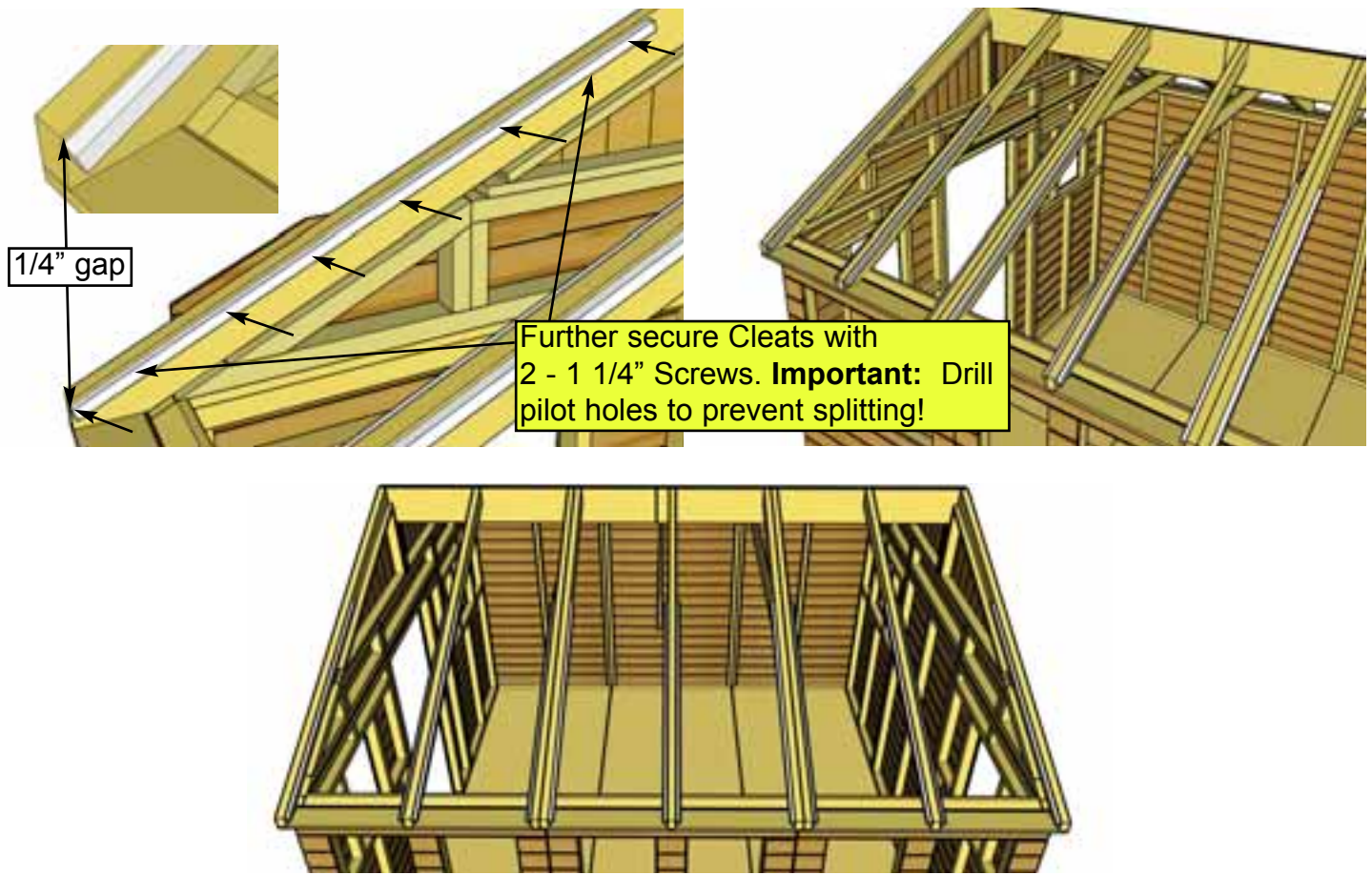

**C16.** Position a Polygal Support Cleat on each Long Rafter flush to end and recessed 1/4" down from top of rafter. Nail to rafter using 6 - 1 1/2" Finishing Nails. **Note:** Start nails in Supports on ground first. Further secure with 2 - 1 1/4" Screws - see diagram above. Complete remaining 11 Polygal Support Cleats.

<u>Parts</u>	<u>Hardware</u>
<b>Polygal Support Cleats</b> (3/4" x 3/4" x 48") x 12	<b>1 1/2" Finishing Nails</b> x 72 total <b>1 1/4" Screws</b> x 24 total

# D. Roof Section - Cedar

Exploded view of all parts necessary to complete the Roof Section. Identify all parts prior to starting.

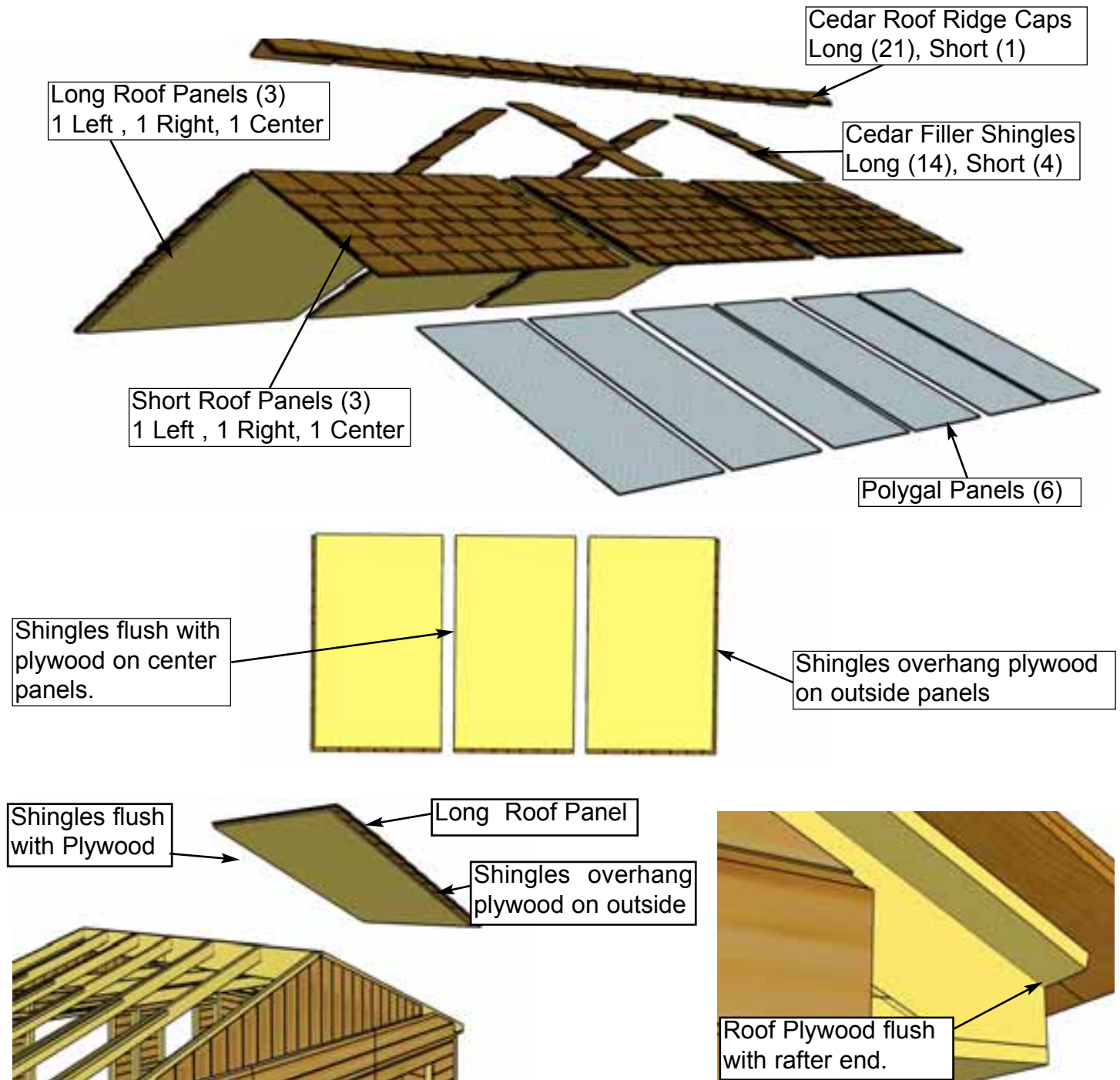

**D1.** Identify all **Roof Panels**. There are 2 Outside Right, 2 Center and 2 Outside Left Roof Panels. The outside of the panels will have shingles overhanging the plywood. Starting with an Outside Long Cedar Shingle Roof Panel, lift up and place on rafters so Plywood is flush with end of Rafter.

<u>Parts (Steps D1 - D4)</u>	<u>Hardware (Steps D1 - D4)</u>
<p><b>Long Roof Panels</b></p> <p>Left/Right Side - 51" x 83 3/4" x 2</p> <p>Center - 45 1/2" x 83 3/4"</p>	<p><b>2 1/2" Screws</b></p> <p>x 4 total</p>

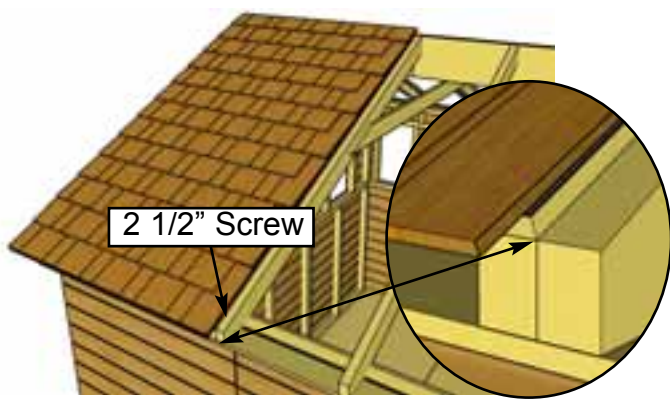

45 1/2" wide  
Center Roof Panel

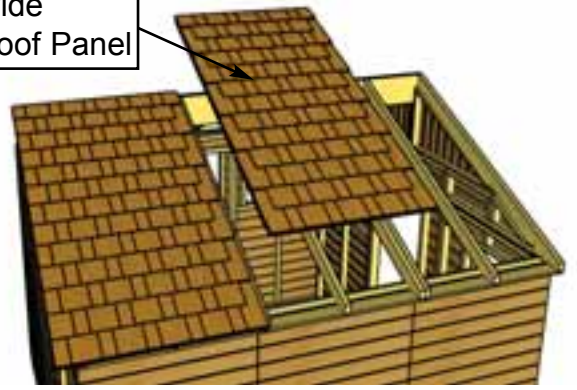

**D2.** Position Panel so roof plywood sits evenly on doubled up Rafters. Screw Panel to Rafters through bottom row of shingles with 1 - 2 1/2" Screw. Lift up and place a Long Center Roof Panel on Rafters. Center Panel will have plywood flush with shingles on both sides. Position evenly on Rafters.

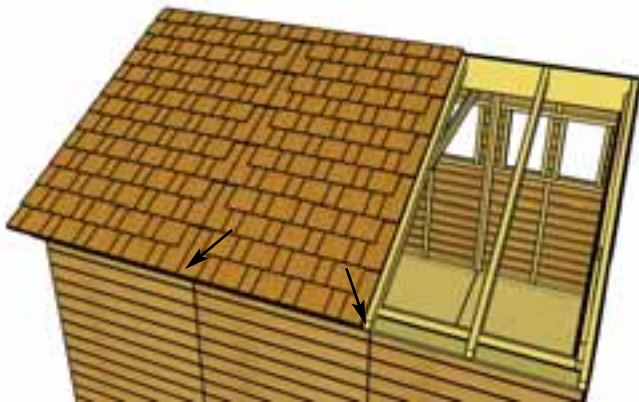

**D3.** Position Center Roof Panel so plywood is flush with end of rafter as per Step D1. From side to side, make sure Roof Panel is sitting equally on rafters. When positioned correctly, screw down with 2 - 2 1/2" Screws into outside lower shingles.

Shingles overhang  
plywood on outside

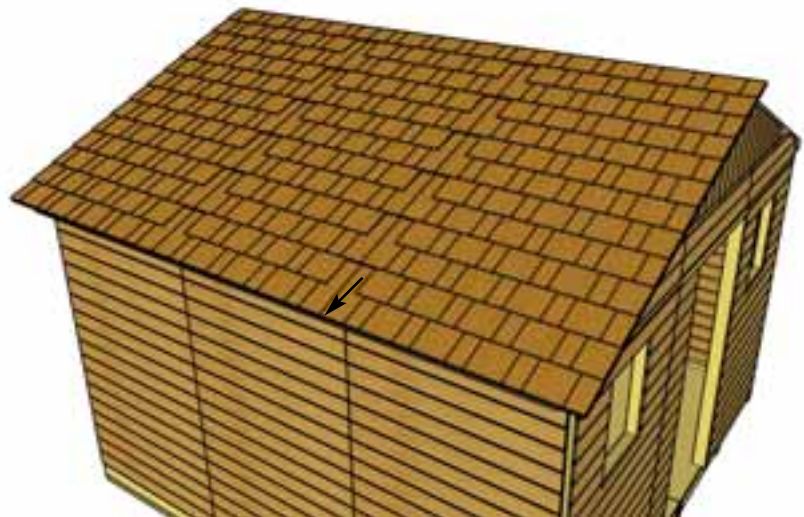
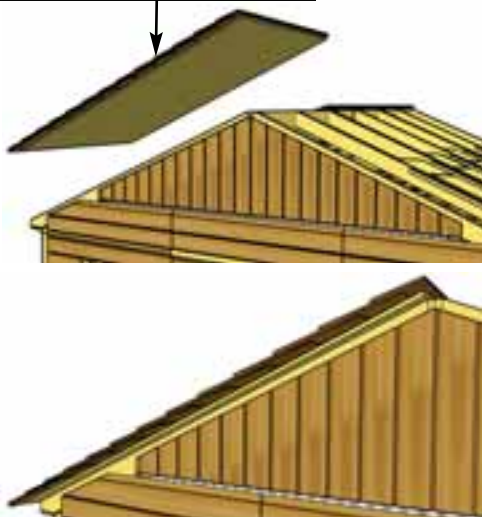

**D4.** Lift up and place remaining Long Outside Roof Panel on rafters. Plywood on roof should be flush with end of rafter at bottom. With Outside Roof Panel centered on rafter and aligned as per Step D2, screw down with 1 - 2 1/2" Screw.

**Polygal Side Short Roof Panel**

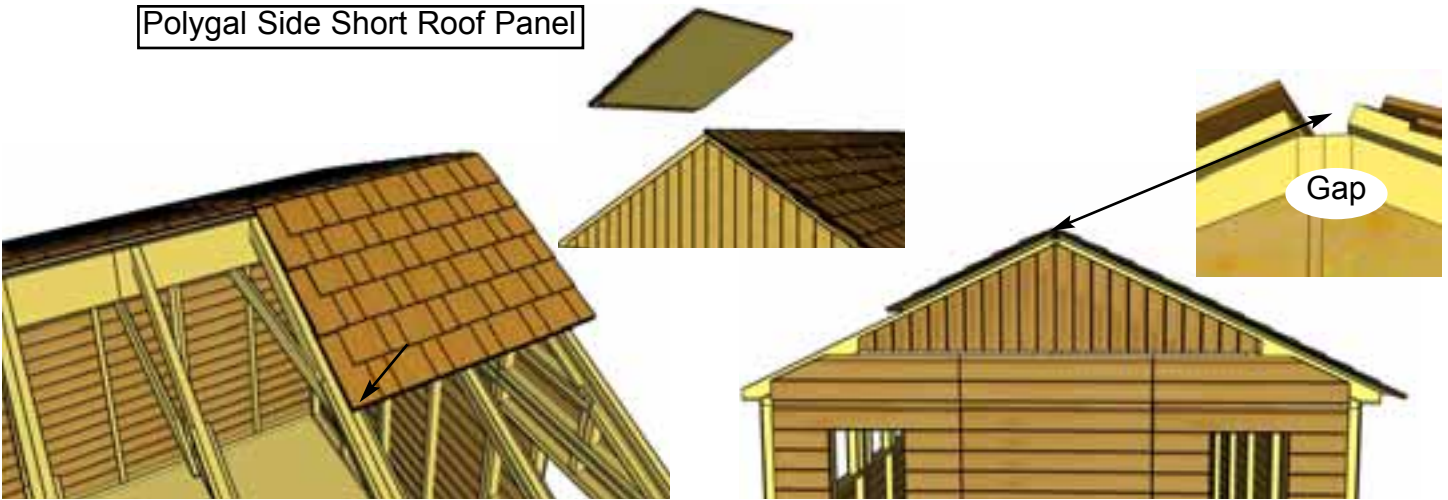

**D5.** Locate **Short Right Roof Panel**. Lift and Place Outside Panel for Polygal Side Roof. Position Outside Roof Panel equally on seam of doubled up rafters as per **Step D2**. Align Roof Panel at top so even with long panel at peak. Reach through opening in Rafters to attach. When positioned correctly, screw down with 1 - 2 1/2" Screw in bottom row of shingles as illustrated above. **Hint:** Work from inside of shed to position and secure Polygal Side Roof Panels.

<p><u>Parts (Steps D5 - D6)</u>  <b>Short Roof Panels</b>                  Left/Right Side 51" x 40 1/2" x 2                  Center - 45 1/2" x 40 1/2"</p>	<p><u>Hardware (Steps D5 - D6)</u>  <b>2 1/2" Screws</b>                  x 4 total</p>
--	---



**Completed Polygal Side Roof Panels**



**D6.** Work from inside the Sunshed when completing Polygal Side Roof Panels. Repeat **Steps D1 - D3** to attach remaining Panels on short roof side. Align evenly at roof peak.



**D7.** Next, time to install **Filler Shingles** to hide roof seams of shed. Starting at bottom on Short Roof Side, push a Long Filler Shingle underneath shingles directly above it until ends are flush.

<p><u>Parts (Step D7 - D9)</u>  <b>Long Filler Shingles x 14</b>  <b>Short Filler Shingles x 4</b></p>	<p><u>Hardware (Step D7 - D9)</u>  <b>1 1/2" Shingle Nails x 8 total</b>  <b>1 1/4" Screws x 28 total</b></p>
--	---

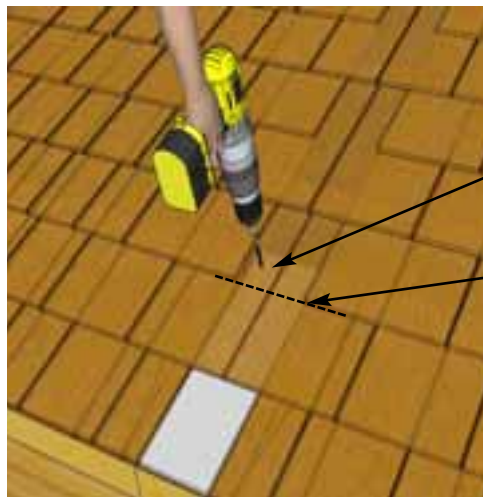

Attach above the exposure line.  
 Exposure Line

**D8.** Screw first filler shingle down to rafters above the exposure line, using 1 - 2 1/2" Screw per panel (2 in total). Make sure to screw into both rafters.

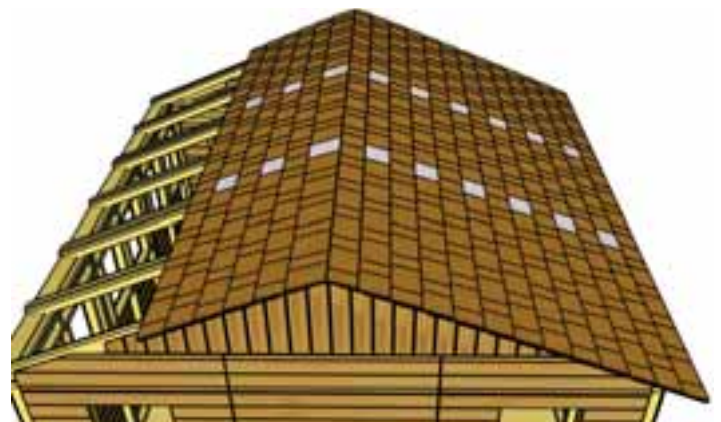
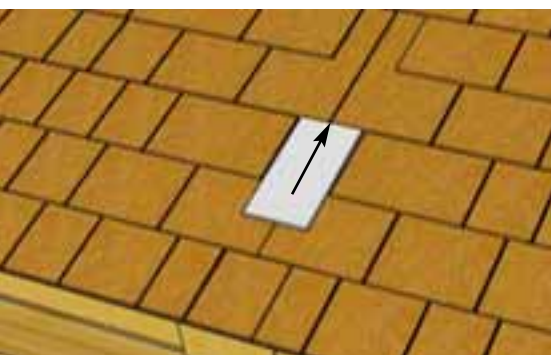

**D9.** Slide in the next Long Filler shingle and attach as per Step D8. At the top, use shorter shingle to fit. Attach top shingle to roof with 2 - 1 1/2" Shingle Nails. Complete for all seams on Short and Long Roofs.

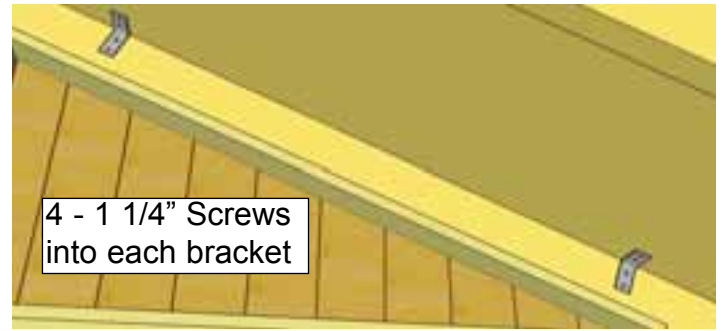
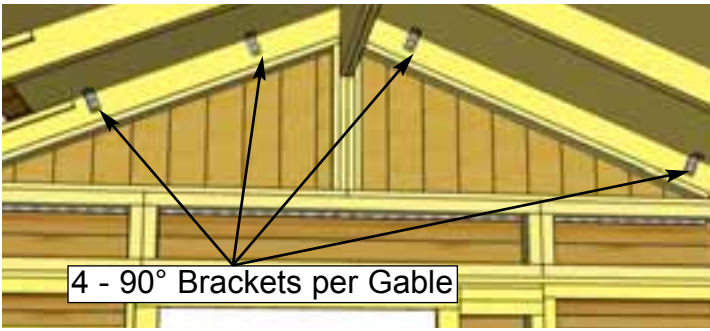

**D10.** Position 4 - 90° Metal Brackets onto the roof plywood and outside rafter. Secure each bracket with 4 - 1 1/4" Screws. Complete for both gables. There are 8 brackets total ( 4 per side).

Hardware  
 1 1/4" Screws  
 x 32 total  
 90° Metal Bracket  
 x 8

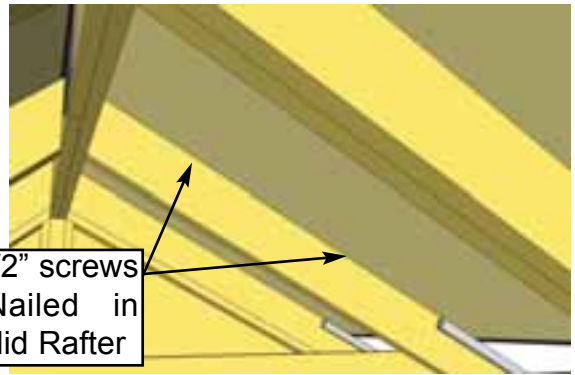
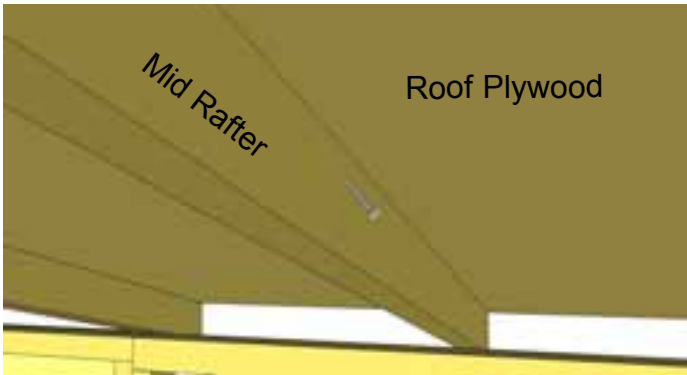

**D11.** To further secure roof panels, from the inside, drill pilot holes on an angle into each Mid Rafter (3 per Rafter on Long Roof Side and 2 on Short Roof Side). Using 2 1/2" Screws, secure rafters to roof plywood.  
**Hint:** have a helper push the roof panel down from the outside so plywood sits flush against the rafter when securing.

Hardware  
 2 1/2" Screws  
 x 15 total

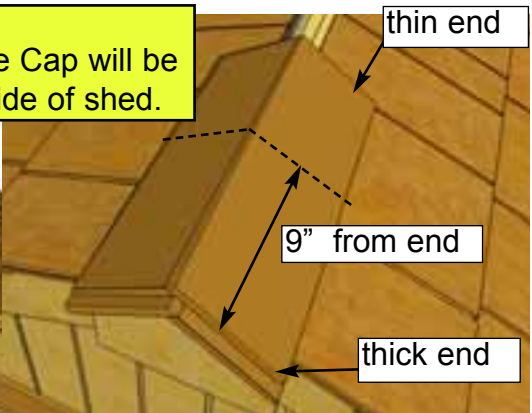
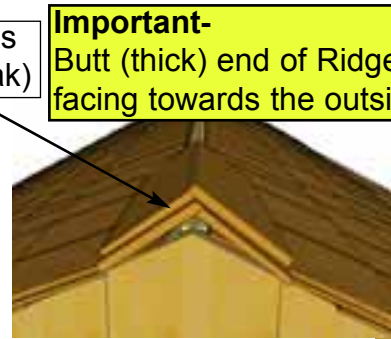
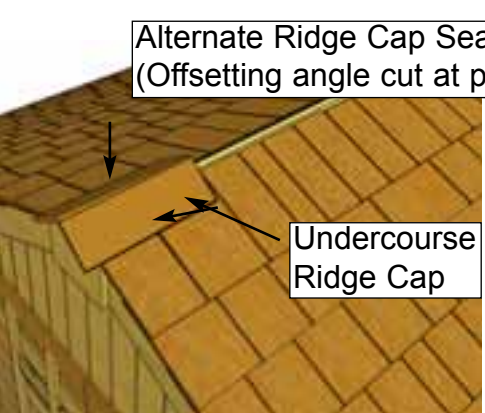

**Important-**  
 Butt (thick) end of Ridge Cap will be facing towards the outside of shed.

**D12.** Place First Roof Ridge Cap (Lower Grade Undercourse Ridge Cap) on roof peak overhanging shingles by approximately 1". Attach with 2 - 1 1/2" Shingle Nails 9" from end. Place 2nd Ridge Cap 1" back from 1st cap. Attach with 2 - 1 1/2" Shingle Nails 9" from end. Alternate each Ridge Cap as you proceed.

Parts (Step D12 - D14)  
 Roof Ridge Caps x 21  
 Center Roof Ridge Cap x 1

Hardware (Step D12 - D14)  
 1 1/2" Shingle Nails  
 x 46 total

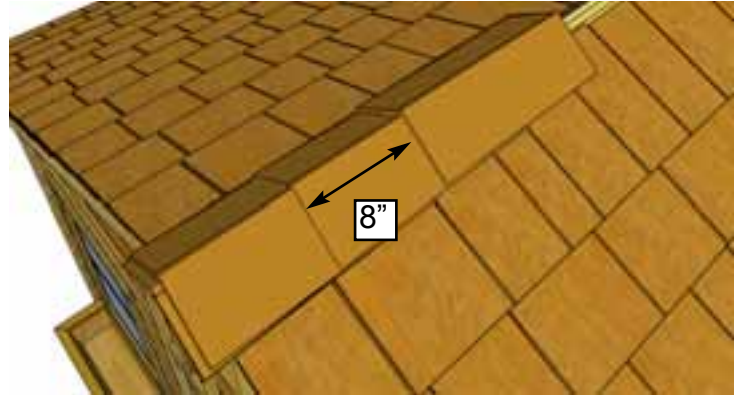
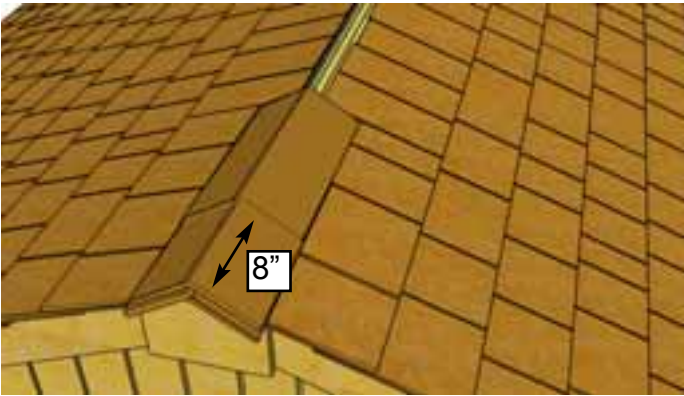

**D13.** Place 3rd Ridge Cap 8" back from 2nd. (enough to cover shingle nails). Attach 3rd Ridge Cap down as per Step D12. Continue to position and attach Ridge Caps until half roof is complete.

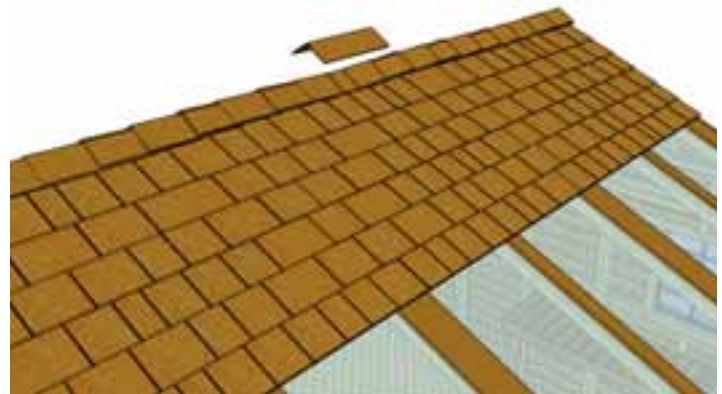
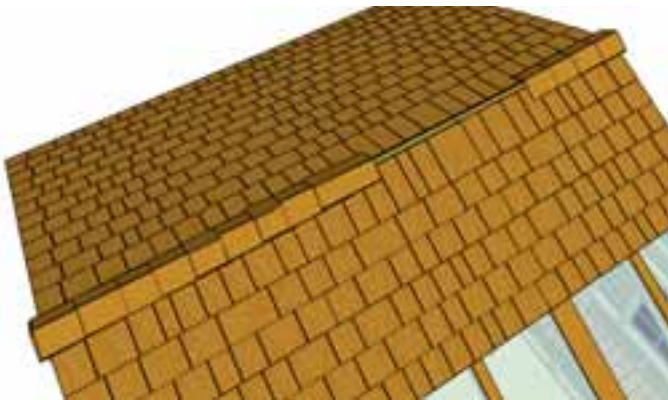

**D14.** From opposite side, position and attach Ridge Caps as described above starting with the Undercourse Ridge Cap. The center Ridge Cap is cut to 12" to fit in the center of roof. Attach center cap with 4 - 1 1/2" Shingle Nails.

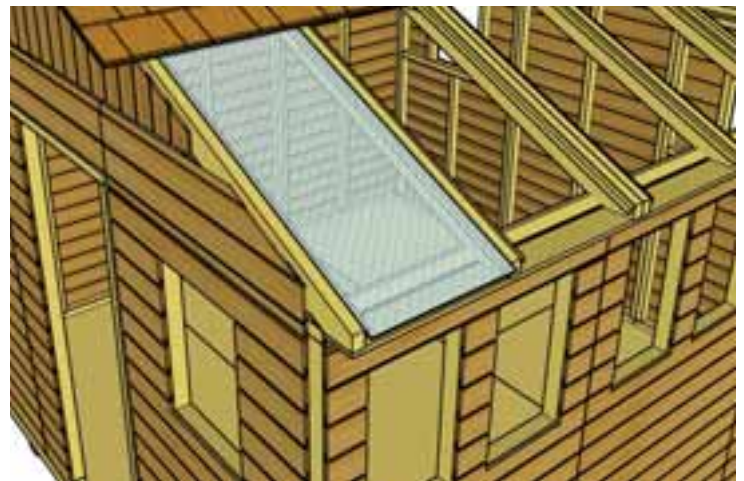

**D15.** Installation of 6 Polygal Panels is next. Start by removing protective plastic layer on each panel. Exterior/interior side of protective polygal film is printed on film, be sure to note the side and install accordingly. Slide panel up between Rafters so it rests on Polygal Support Cleats. From the inside, carefully slide end of panel underneath plywood. Position Polygal Panel equally between Rafters. Polygal Panel will overhang the end of Rafters by 1/2".

Parts (Steps D15 - D17)  
**Polygal Panels**  
 (20 1/4" x 48") x 6

Hardware (Steps D15 - D17)  
**1" Screws x 54 total**

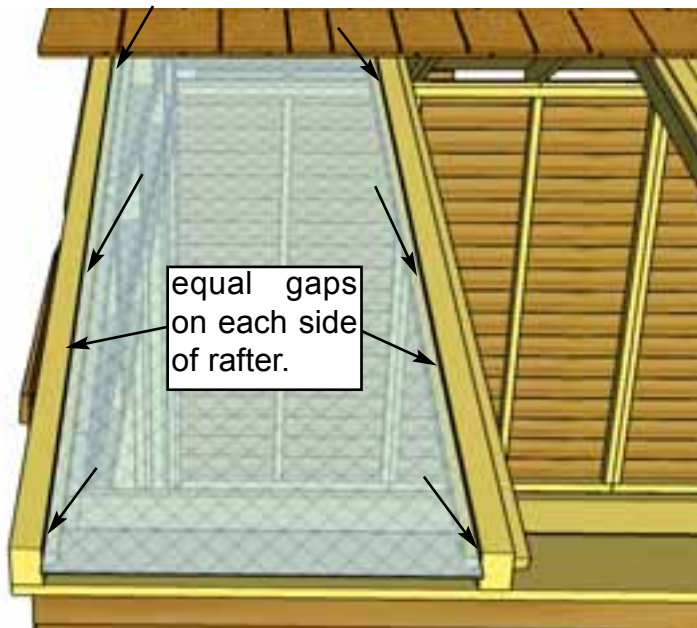

**D16.** Drill pilot holes with 1/8" bit through Polygal Panel and Polygal Support Cleats. Once aligned, with 6 - 1" Screws, secure panel to Polygal Support Cleats. Polygal is delicate, tighten screws a half turn at a time so screws are flush with top of Polygal Panel. Use 3 - 1" Screws to secure Polygal Panel to underside of Roof Plywood.



**D17.** Position and secure remaining Polygal Panels as per Steps D15 - D16. With a caulking gun, apply silicone to seal gaps between Rafters and Polygal Panels. Apply silicone down each side of Rafter. Use liberal amounts to properly seal.

# D. Roof Section - Metal

Exploded view of all parts necessary to complete the Roof Section. Identify all parts prior to starting.

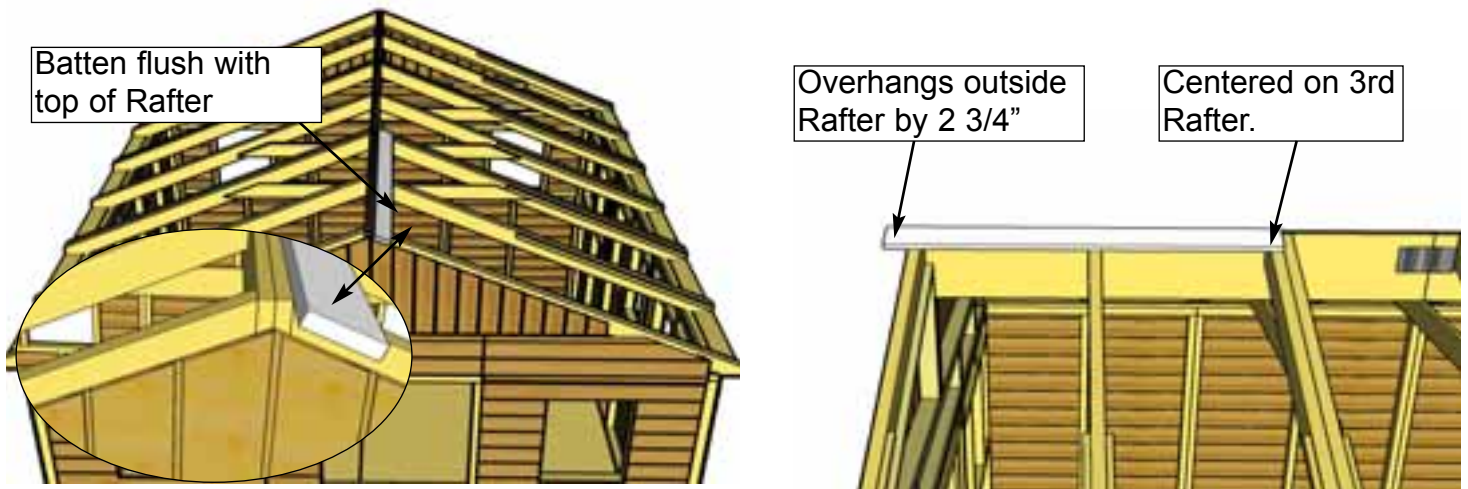
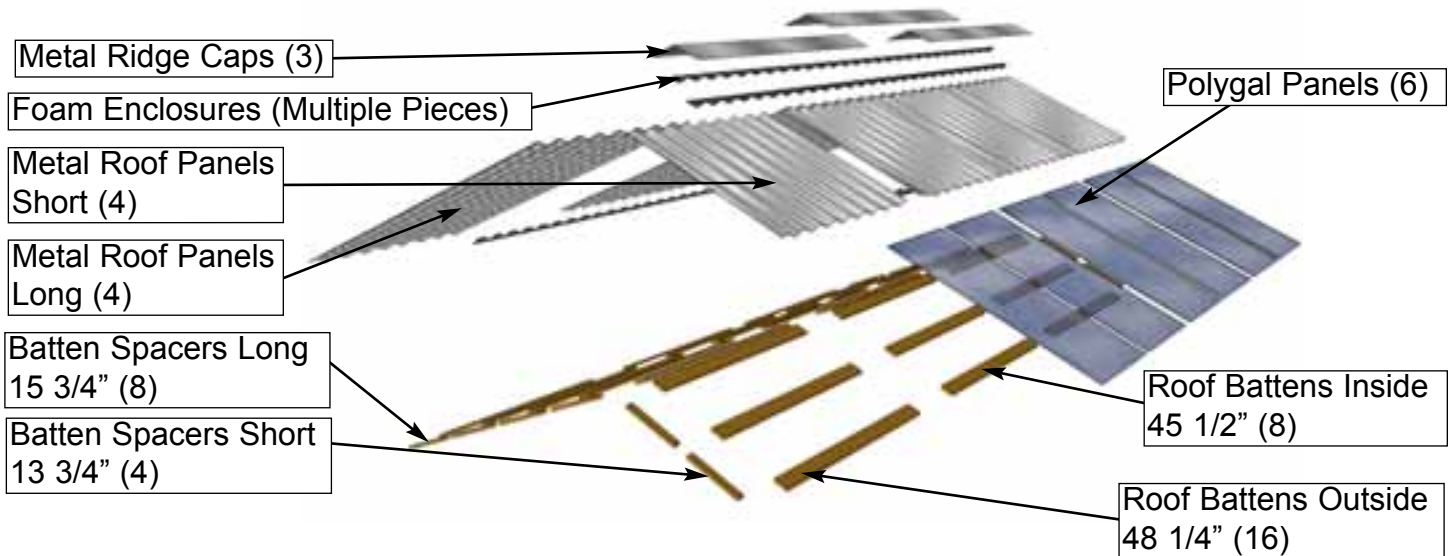

**D1.** Starting on the polygal side locate **Outside Roof Battens** and place on roof rafters. Place at top of Rafter section where Rafter and Ridge Board meet. Batten should be positioned evenly on 3rd rafter. Batten will overhang outside Rafter by 2 3/4".

Parts (Steps D1 - D6)

- Outside Roof Battens (3/4" x 3 1/2" x 48 1/4") x 16
- Inside Roof Battens (3/4" x 1 1/2" x 45 1/2") x 8
- Short Batten Spacers (3/4" x 1 1/2" x 13 3/4") x 4
- Long Batten Spacers (3/4" x 1 1/2" x 15 3/4") x 8

Hardware (Steps D1 - D6)

- 1 1/4" Screws x 96 total

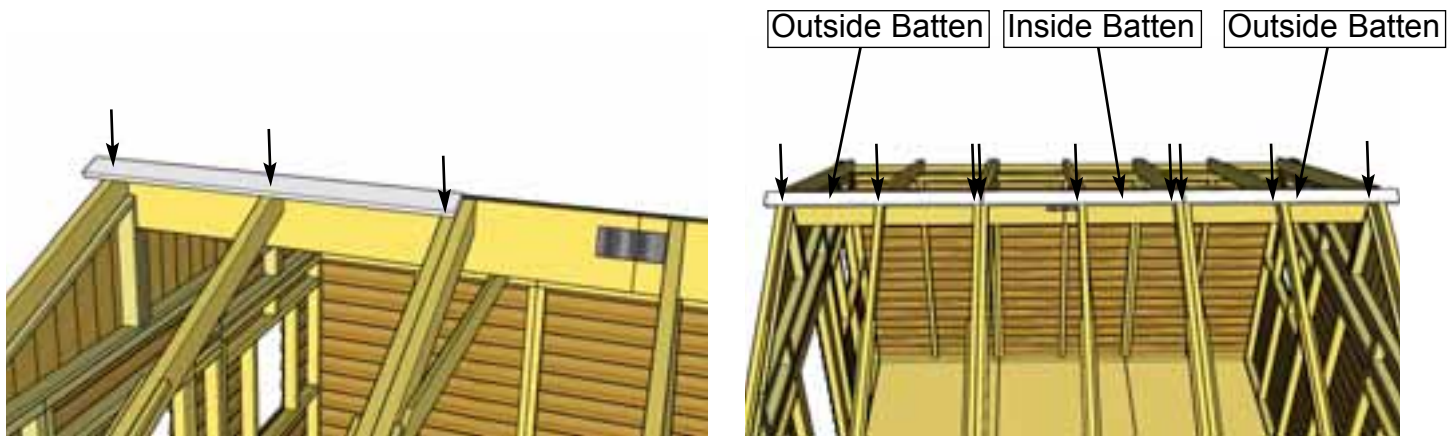

**D2.** Attach **Batten** to Rafters with 3 - 1 1/4" Screws per Rafter Section. **Important:** pre-drill with 1/8" drill bit first to prevent end from splitting. Place **Inside Roof Batten** next to the first and attach with 3 - 1 1/4" Screws. Place **Outside Roof Batten** next to this inside batten and attach with 3 - 1 1/4" Screws.

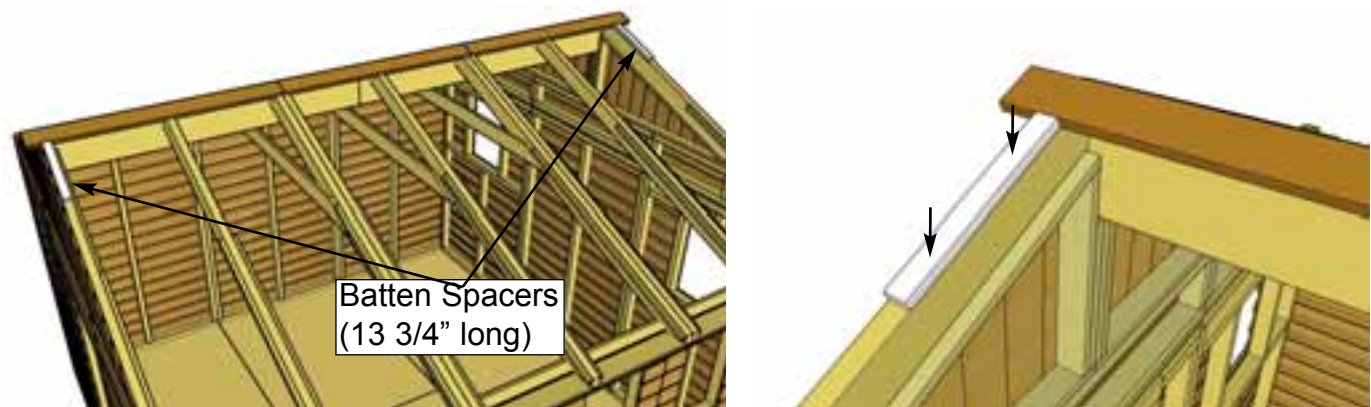

**D3.** Locate **Batten Spacers Short**. Place one spacer below each Batten lengthwise along outside Rafter. Attach each Spacer to Outside Rafter with 2 - 1 1/4" screws per spacer (4 total).

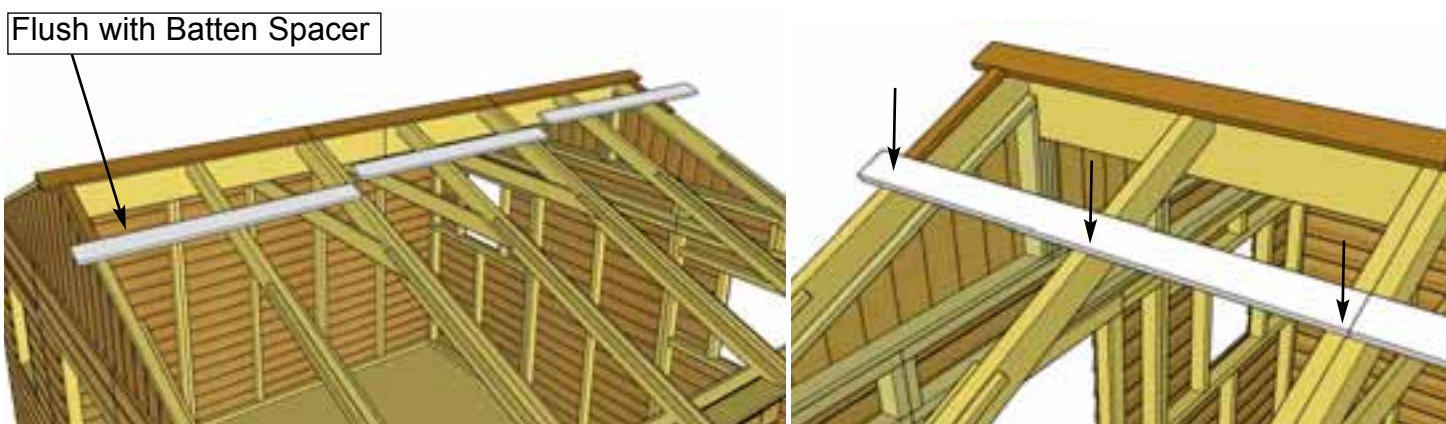

**D4** Locate two Outside Roof Battens and one Inside Roof Batten. Position and attach 2nd row of battens 13 3/4" from first row of battens flush against Batten Spacer. Outside Battens overhang Outside Rafter by 2 3/4" as per **Step D1**. Attach each batten with 3 - 1 1/4" screws (9 total for the row)

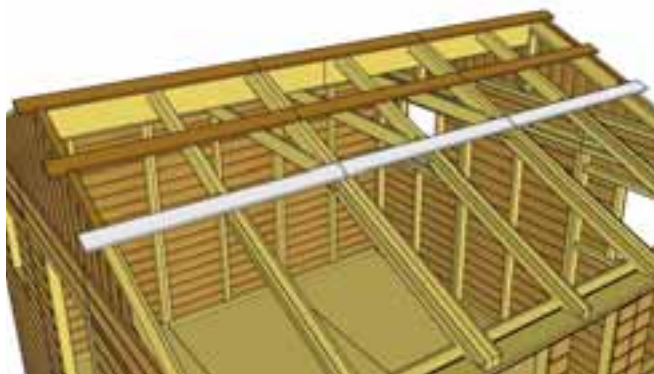

**D5.** Locate two more **Short Batten Spacers** and attach below 2nd row of **Battens** as per **Step D3**. Then Locate two more **Inside Roof Battens** and one **Outside Roof Batten** and attach as per **Step D4**

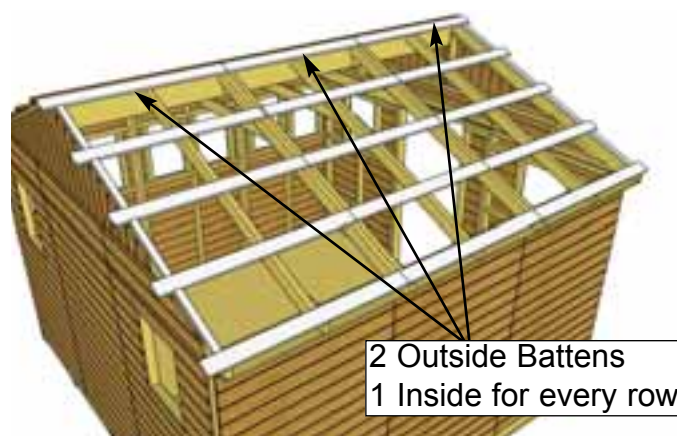
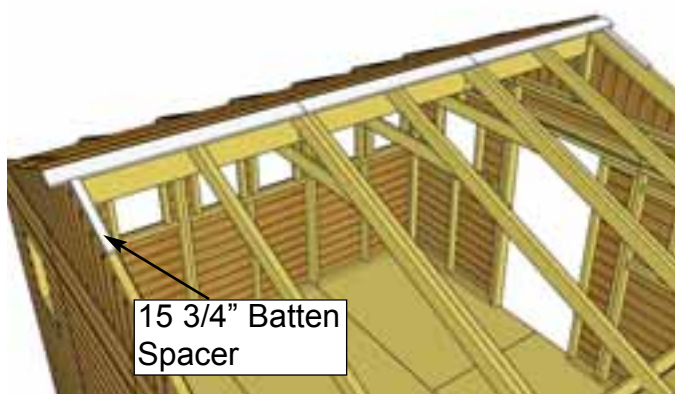

**D6.** Position 1st row of **Outside and Inside Battens** on non-polygal side and attach as per **Steps D1 - D2**. Attach **Batten Spacer Long** below 1st row of **Battens**. Continue attaching **Spacers and Battens** as per **Steps D4 - D5** until you complete all 5 rows. **Final Row** near soffit should land  $\frac{3}{8}$ " from end of **Rafter**. Use a total of **61 - 1 1/4" Screws** to complete non-polygal side of roof.

**Important:** Do not fasten down Roof Panels with Hangers still in place. Metal Roof Hangers will temporarily help keep Metal Roof Panels in place before they are fastened.

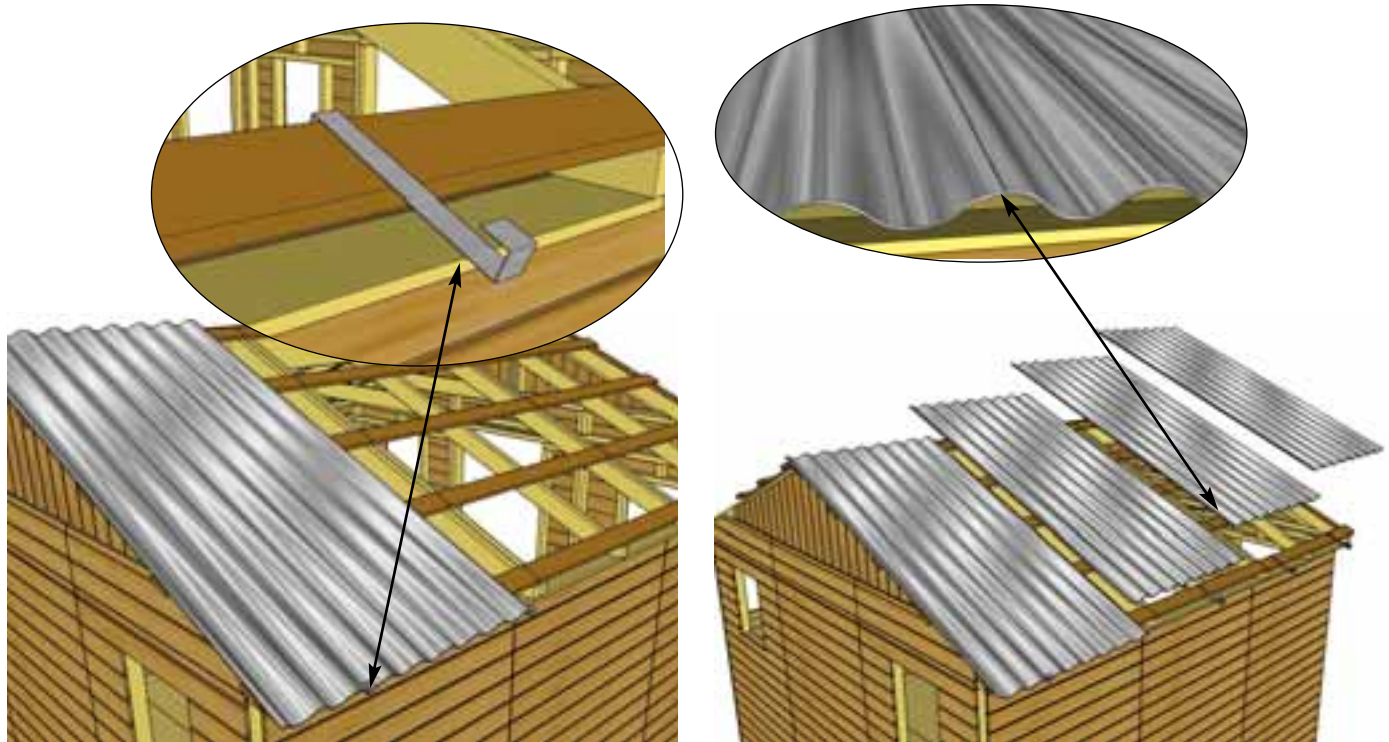

**D7.** Starting on the non-polygal side, locate **4 Long Metal Roof Panels** and **4 Metal Roof Hangers**. To temporarily hold the Metal Roof Panels in place, hook a Metal Roof Hanger onto the lowest Batten approximately where the center of the first Panel will be. Place the first Metal Roof Panel on Battens. Do not fasten Panels down until **Step D11**. Place Remaining 3 Panels and Hangers on the same way. Metal Roof Panels overlap each other.

<p><u>Parts (Steps D7 - D15)</u></p> <p><b>Metal Roof Panels (Short Side)</b> (39" x 41") x 4</p> <p><b>Metal Roof Panels (Long Side)</b> (39" x 86") x 4</p>	<p><u>Hardware (Steps D7 - D15)</u></p> <p><b>Metal Roof Screws</b> x 36 total</p> <p><b>Metal Roof Hangers</b> x 4 total</p> <p><b>Foam Enclosures</b> x 8 total</p>
---	---



**D8.** Overhang the **Metal Roof Panels** past the **Battens** on sides by approximately 1". Adjust panels side to side to achieve desired width Overall width past the Battens can vary from 1" - 3" depending on your preference. The overhang over the side of the shed will be set by the Metal roof Hangers, but should be approximately 4" on the side of shed.

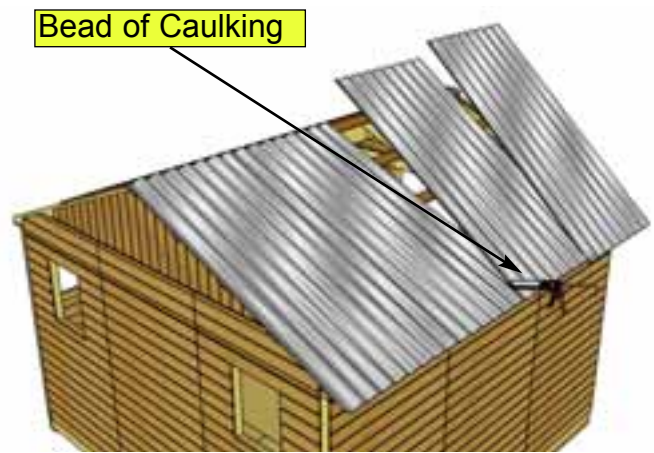
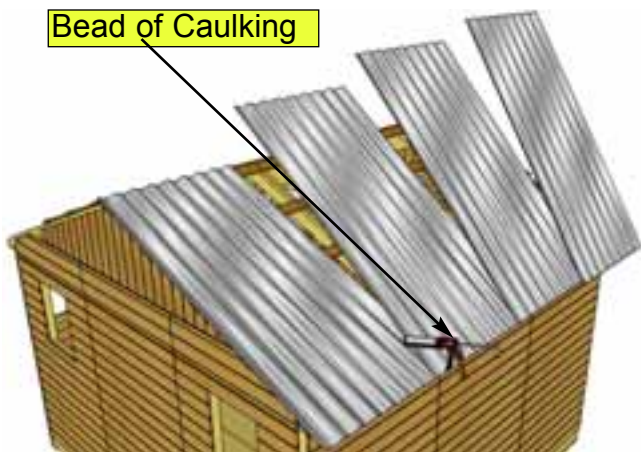

**D9.** Once Metal Roof is spaced correctly from side-to-side and top-to-bottom, lift 3 panels up and run a bead of caulking down the overlapping seams of each panel to seal the joints. Place panels down one by one once seam is caulked. You will likely need assistance from a helper for this step. Caulk each seam.



**D10.** Using 6 - 1 1/2" Metal Screws and 1/4" Nut Driver (included), partially secure Metal Roof Panels down to middle Batten row. Only fasten screws halfway so that the Metal Roof Hangers can be removed. Metal screw is self-tapping, screw into the center of Battens. Eighteen more 1 1/2" Metal Screws and six more 1 1/2" screws will be required to further secure Metal Roof Panels and to complete Metal Ridge Caps in later steps once Metal Roof Hangers are Removed.

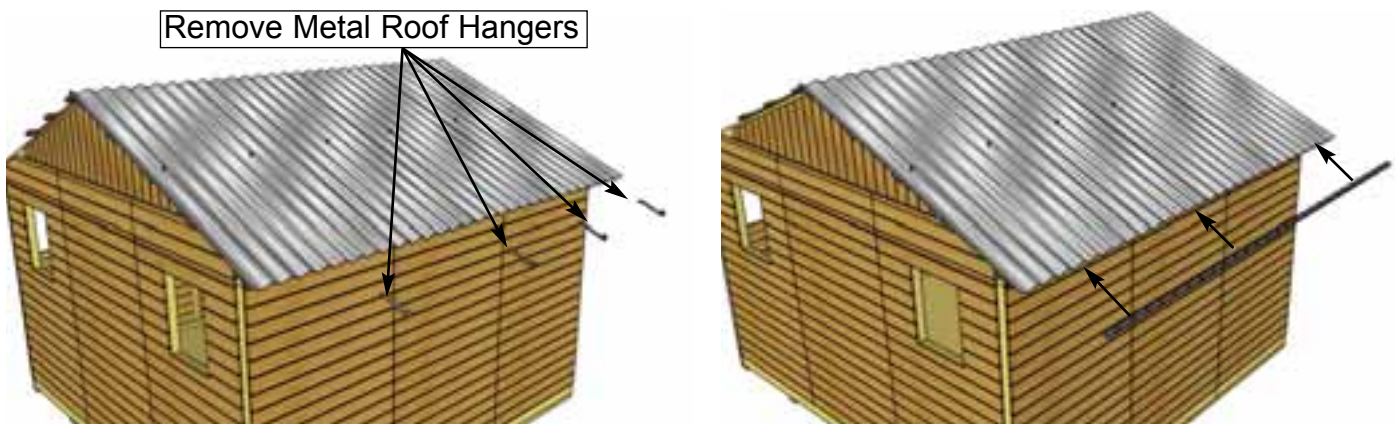

**D11.** Before fully fastening Metal Roof Panels down, remove the Metal Roof Hangers and insert Foam Enclosures between Metal Roof Panels and Battens at the bottom of the roof. Enclosures will prevent moisture and unwanted bugs, etc from entering your shed through here.

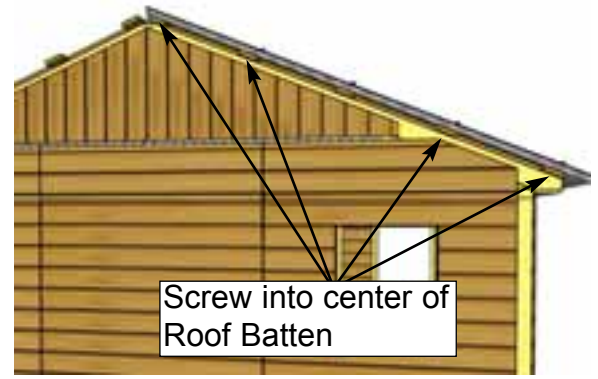
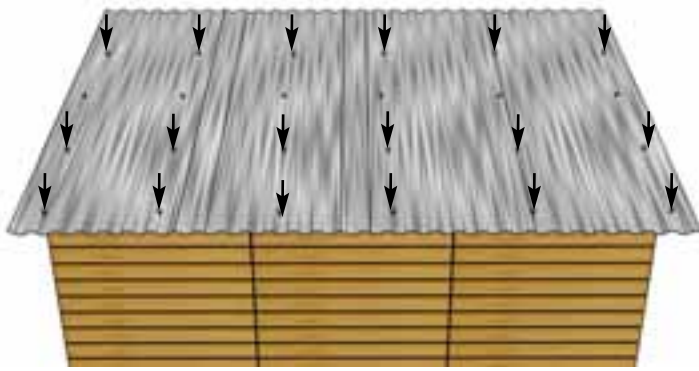

**D12.** Using 18 - 1 1/2" Metal screws and 1/4" Nut Driver, secure **Metal Roof Panels** down to remaining lower 3 rows of Battens. Leave the top row unsecured to secure Ridge Cap in **Step D17** Tighten screws in middle row that were partially attached in **Step D10**. Do not overtighten!

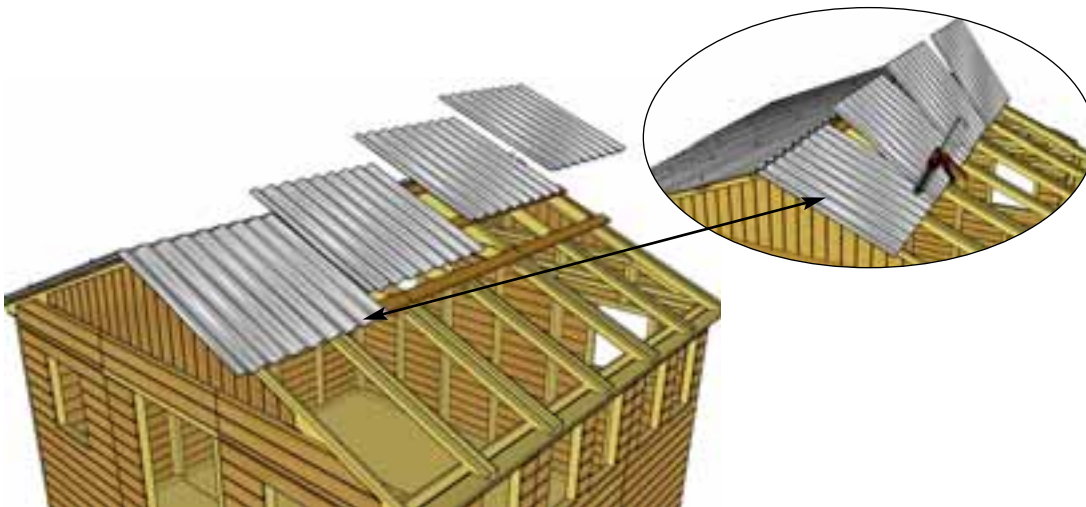

**D13.** Move to polygal side of roof and locate **Short Metal Roof Panels**. Space panels apart as per **Step D7** to match opposite side. **Short Metal Roof Panels** will overhang lowest Batten by approximately 2 1/4". Caulk seams between panels before fastening. **Note:** Metal Hanger brackets do not set length of short panel side. Use a helper to hold the short panels in place.

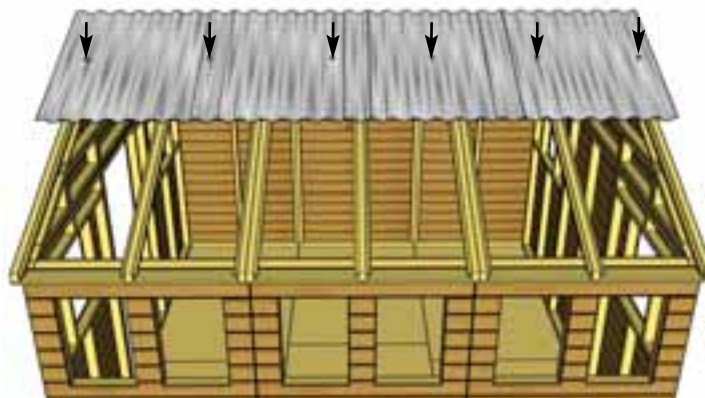

**D14.** Attach Panels to middle row of Battens with 6 - 1 1/2" Metal screws.

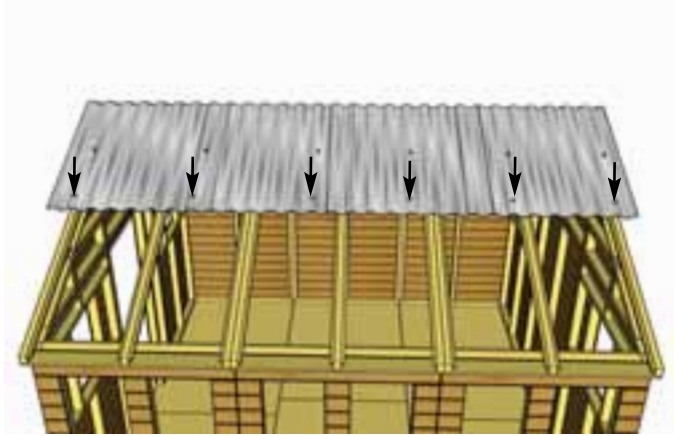

**D15** Locate **Foam Enclosures for Metal Roof**. Insert Foam Enclosures between lowest Batten and Metal Roof Panels. Attach Roof Panel to lowest Batten with **6 - 1 1/2" Metal screws**.

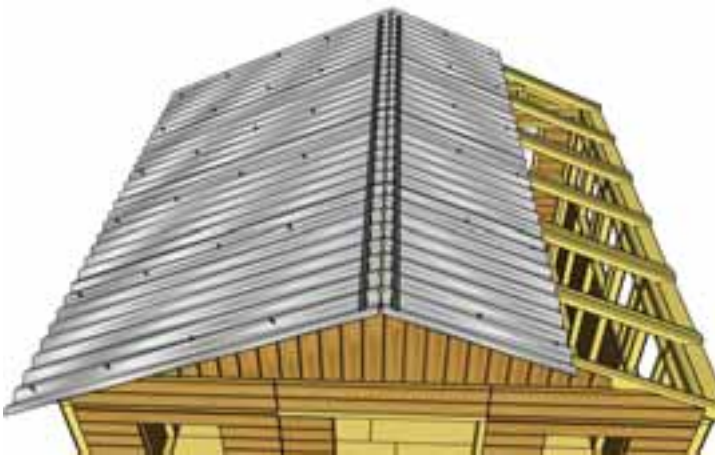

**D16.** Locate remaining **Foam Enclosures for Metal Roof** and **Metal Ridge Caps (60" long)**. Place Foam enclosures at the top of the roof panels. Foam Enclosures prevent moisture from coming in through the top. Place **3 Metal Ridge Caps** onto apex of roof. Evenly spaced from front to back of shed. Caps will overlap each other. Overhang the cap approximately 1-2" past each end.

<p><u>Parts (Steps D16 - D17)</u>  <b>Metal Ridge Caps</b>          (60") x 3</p>	<p><u>Hardware (Steps D16 - D17)</u>  <b>Metal Roof Screws</b>          x 12 total  <b>Foam Enclosures</b>          x 4 total</p>
---	---



**D17.** When Ridge Cap is correctly positioned, secure with 12 - 1 1/2" metal screws (6 per side). Screw into final Batten. Do not overtighten.



**D18.** Installation of 6 Polygal Panels is next. Start by removing protective plastic layer on each panel. Exterior/interior side of protective polygal film is printed on film, be sure to note the side and install accordingly. Slide panel up between Rafters so it rests on Polygal Support Cleats. From the inside, carefully slide end of panel underneath plywood. Position Polygal Panel equally between Rafters. Polygal Panel will overhang the end of Rafters by 1/2".

<p><u>Parts (Steps D18 - D20)</u>  <b>Polygal Panels</b>          (20 1/4" x 48") x 6</p>	<p><u>Hardware (Steps D18 - D20)</u>  <b>1" Screws</b> x 54 total</p>
---	---

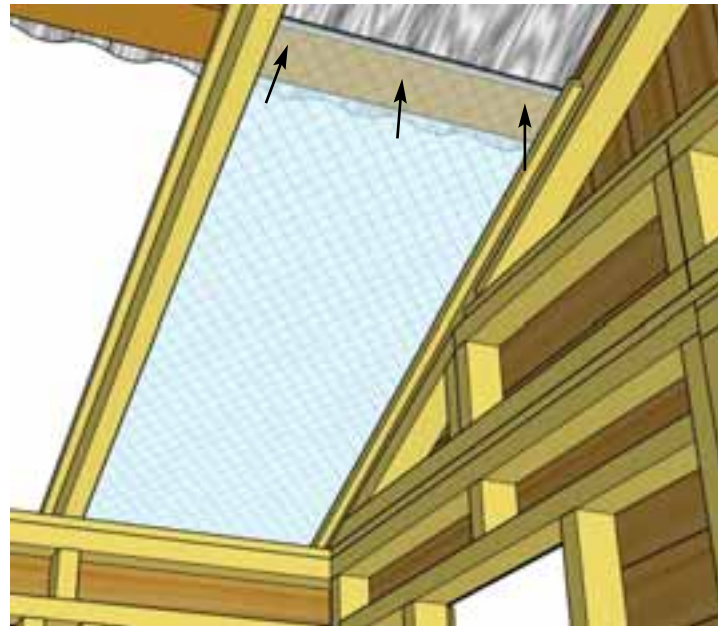
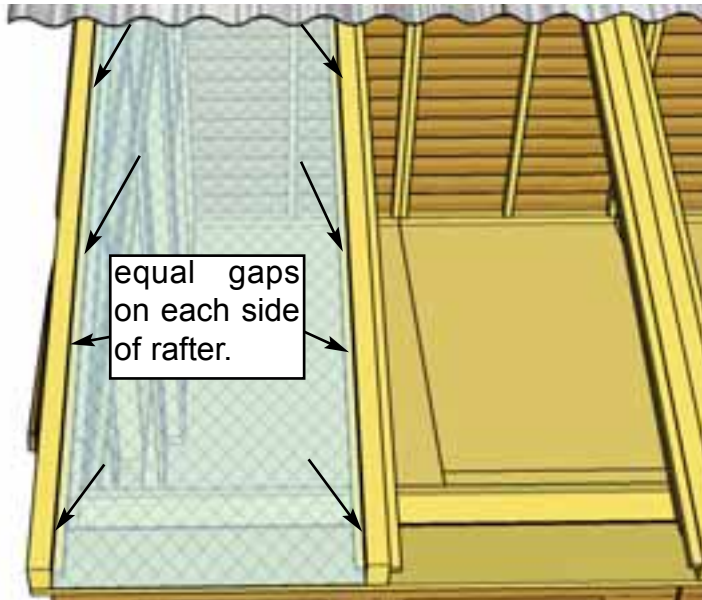

**D19.** Drill pilot holes with 1/8" bit through Polygal Panel and Polygal Support Cleats. Once aligned, with 6 - 1" Screws, secure panel to Polygal Support Cleats. Polygal is delicate, tighten screws a half turn at a time so screws are flush with top of Polygal Panel. Use 3 - 1" Screws to secure Polygal Panel to underside of Roof Plywood.



**D20.** Position and secure remaining Polygal Panels as per Steps D18 - D19. With a caulking gun, apply silicone to seal gaps between Rafters and Polygal Panels. Apply silicone down each side of Rafter. Use liberal amounts to properly seal.

# D. Roof Section - Plywood

Exploded view of all parts necessary to complete the Roof Section. Identify all parts prior to starting.

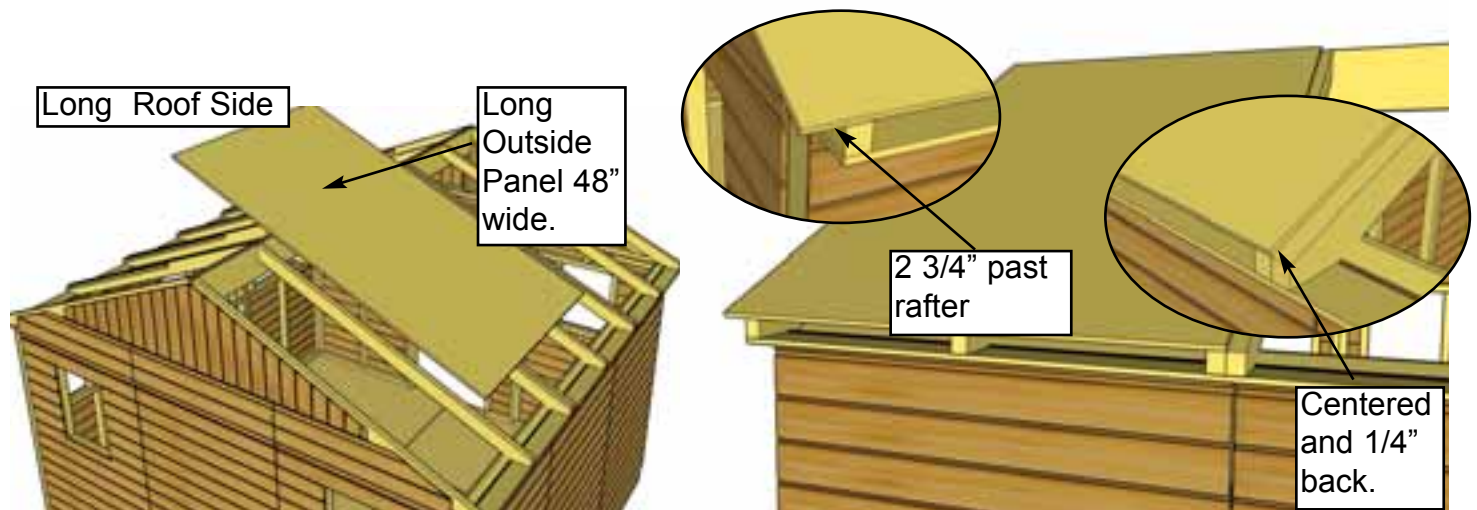
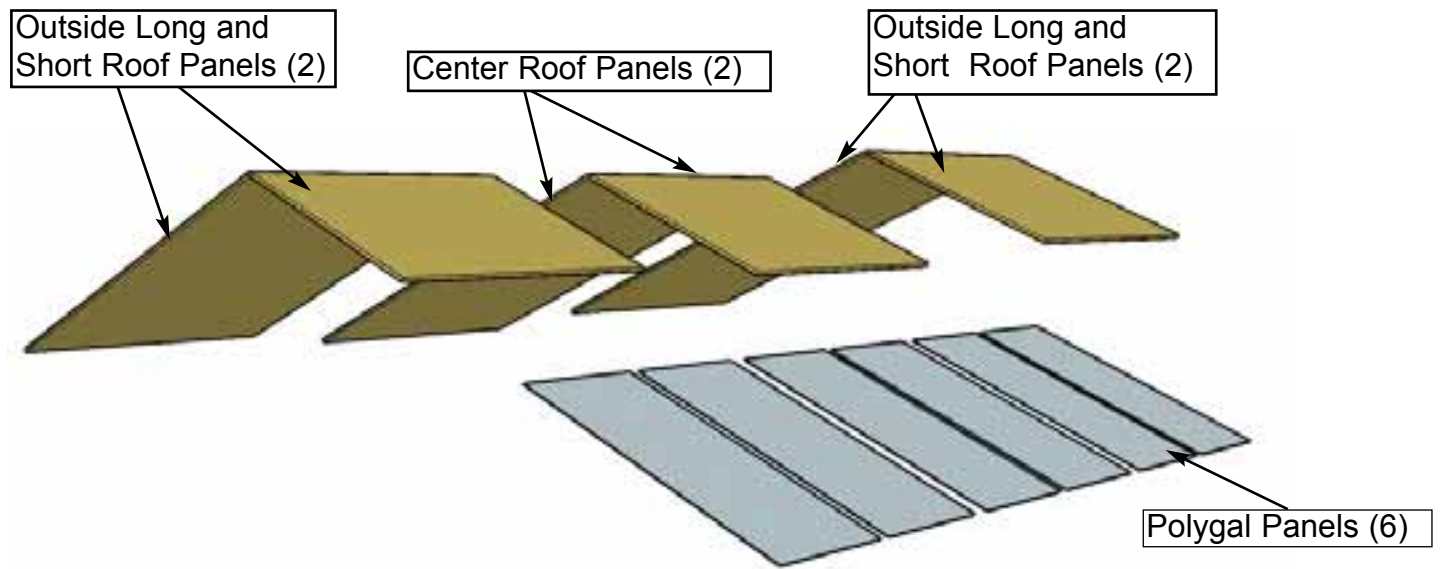

**D1.** Identify all **Plywood Roof Panels**. There are 2 Outside Long, 2 Outside Short and 2 Center (Long and Short) Panels. Starting with an Outside Long, lift up and place on rafters so Plywood is even on double rafter and 1/4" back.

Parts (Steps D1 - D8)	Hardware (Steps D1 - D8)
<p><b>Roof Plywood Outside Long</b> (5/8" x 48" x 81 1/2") x 2</p> <p><b>Roof Plywood Center Long</b> (5/8" x 45 1/2" x 81 1/2")</p> <p><b>Roof Plywood Outside Short</b> (5/8" x 48" x 38 3/4") x 2</p> <p><b>Roof Plywood Center Short</b> (5/8" x 45 1/2" x 38 3/4")</p>	<p><b>1 1/4" Screws</b> x 45 total</p>

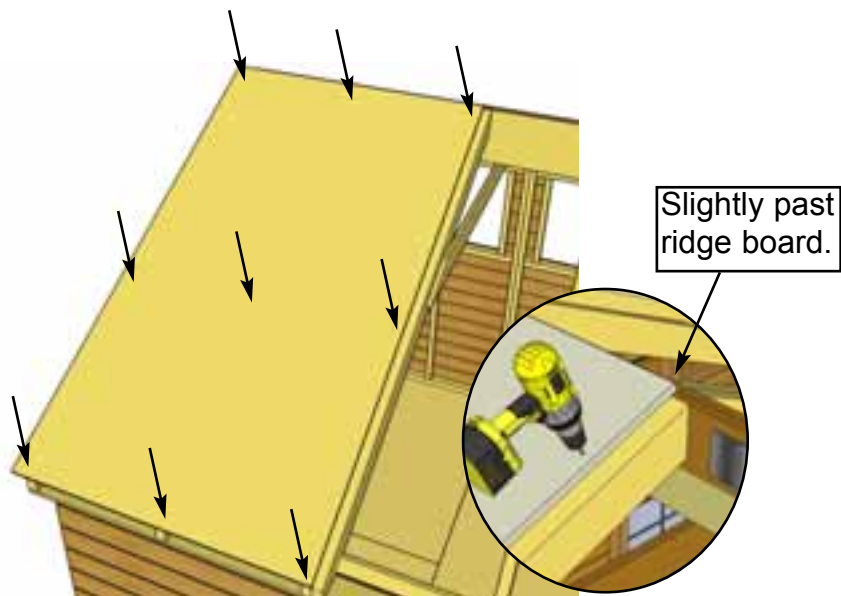

**D2.** Screw Panel to Rafters through with 9 - 1 1/4" Screws.

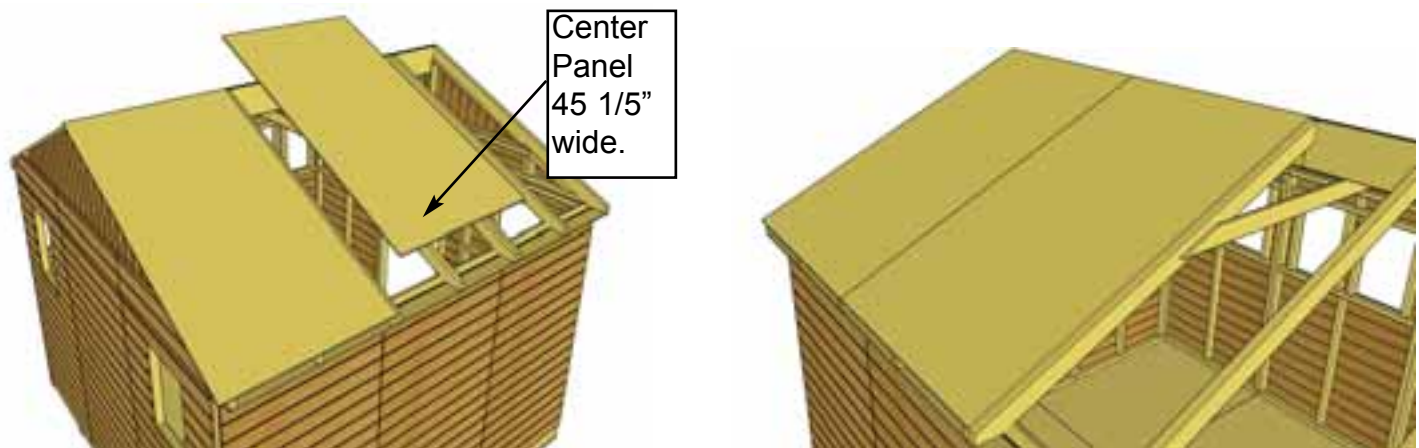

**D3.** Lift up and place a Long Center Roof Panel on Rafters. Center Panel evenly on double rafters. Position Center Plywood Roof Panel recessed back from the end of the rafters by 1/4" and attach to rafters as per **Step D2**.

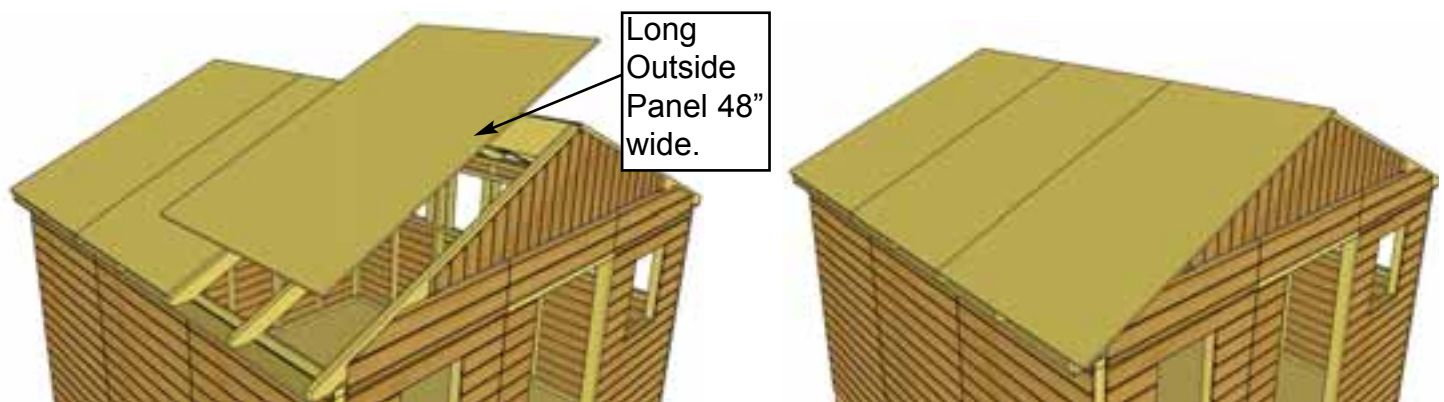

**D4.** Lift up and place remaining Long Outside Plywood Roof Panel on rafters. Position and attach as per **Steps D1 - D2**.

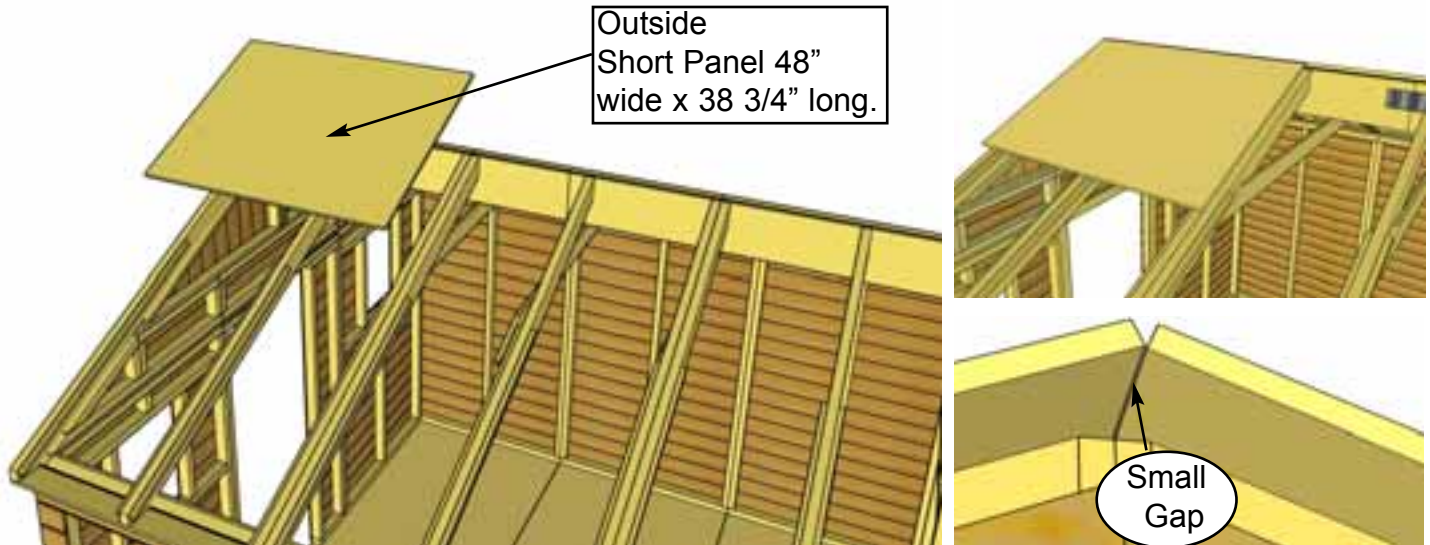

**D5.** Lift and place Outside Short Plywood Roof Panel on Polygal Roof side. Position on rafters as per **Step D1**. Position panel so only a small gap exists at the apex of the shed.

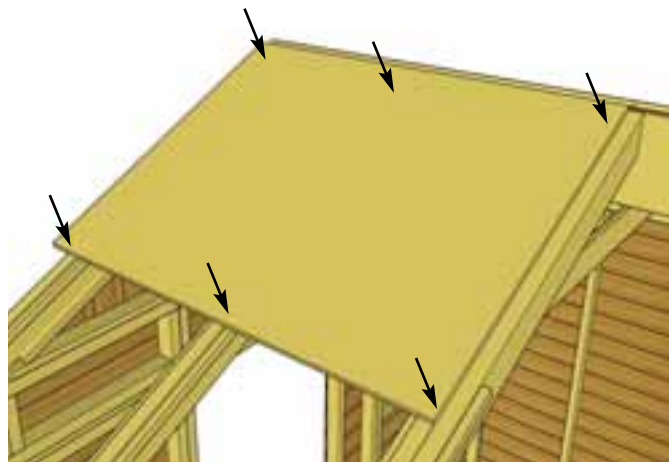

**D6.** When properly positioned, attach with 6 - 1 1/4" Screws.

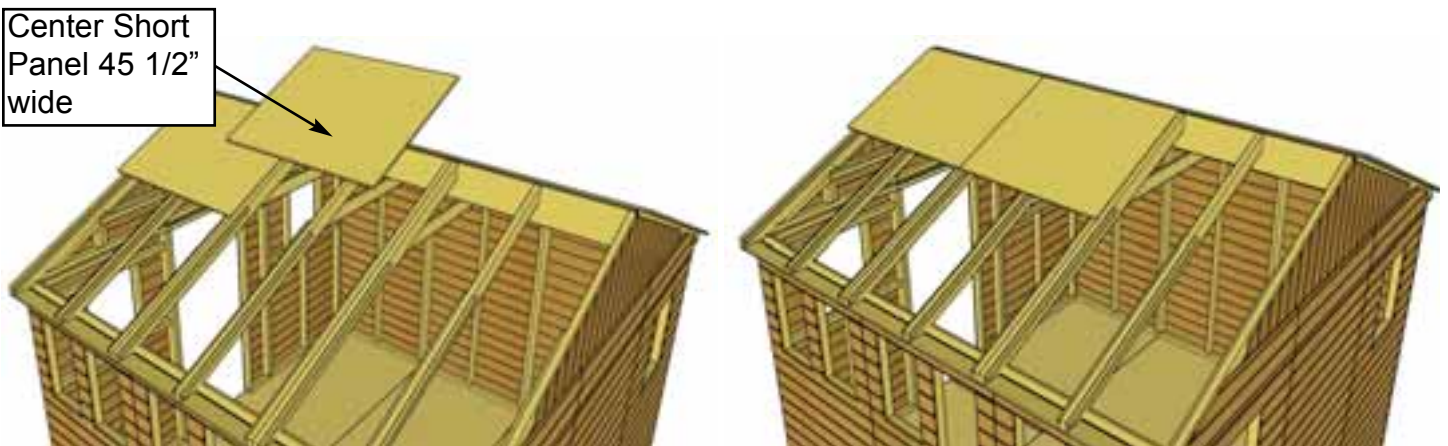

**D7.** Place Center Short Plywood Roof Panel on center double rafters as per. Attach center panel as per **Step D6**.

Completed Polygal Side Roof Panels

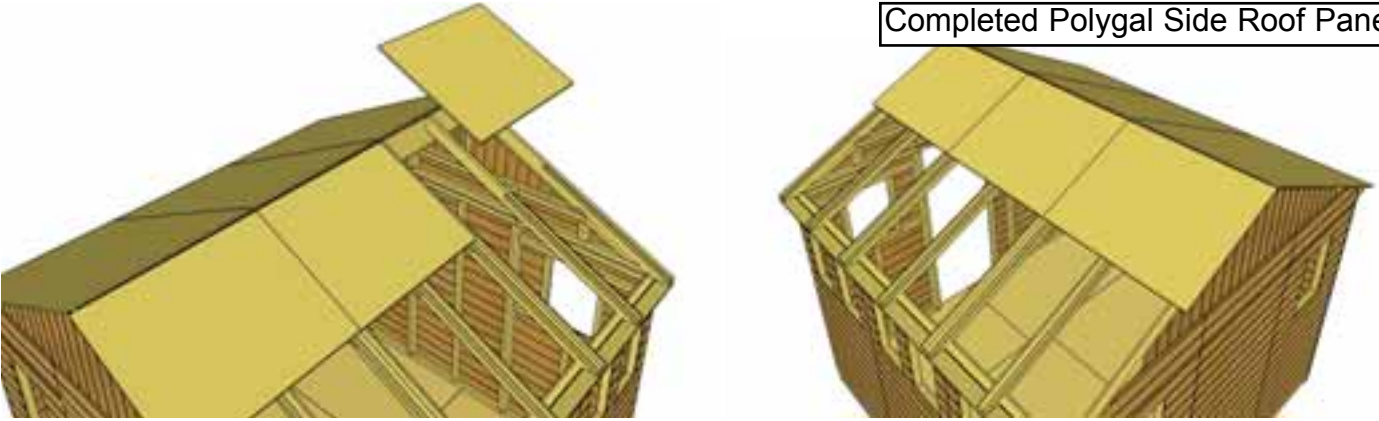

**D8.** Position remaining Short Outside Roof Panel and attach as per Steps D6.

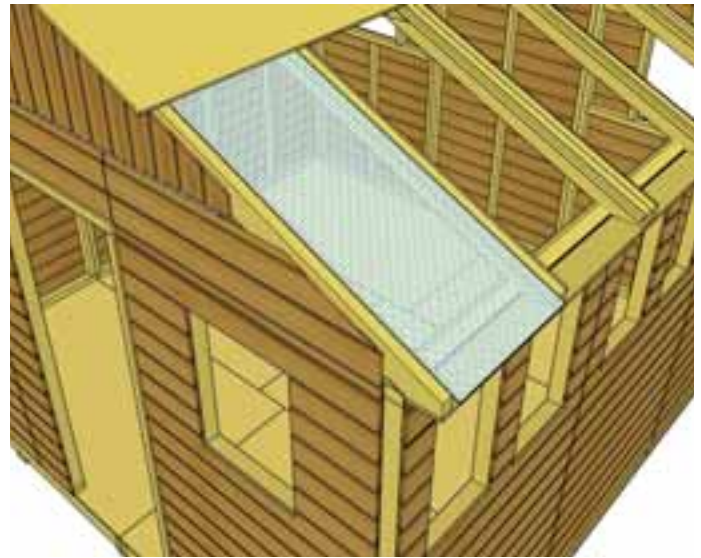
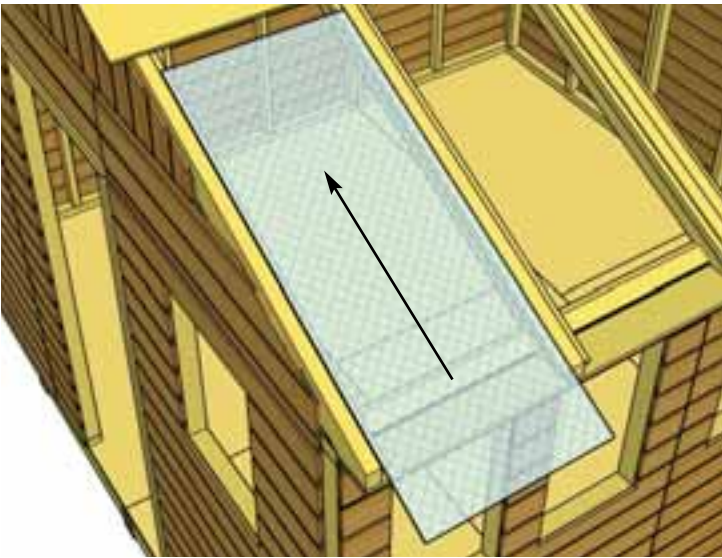

**D9.** Installation of **6 Polygal Panels** is next. Start by removing protective plastic layer on each panel. Exterior/interior side of protective polygal film is printed on film, be sure to note the side and install accordingly. Slide panel up between Rafters so it rests on Polygal Support Cleats. From the inside, carefully slide end of panel underneath plywood. Position Polygal Panel equally between Rafters. Polygal Panel will overhang the end of Rafters by 1/2".

<p><u>Parts (Steps D9 - D11)</u> <b>Polygal Panels</b> (20 1/4" x 48") x 6</p>	<p><u>Hardware (Steps D9 - D11)</u> <b>1" Screws x 54 total</b></p>
--	---

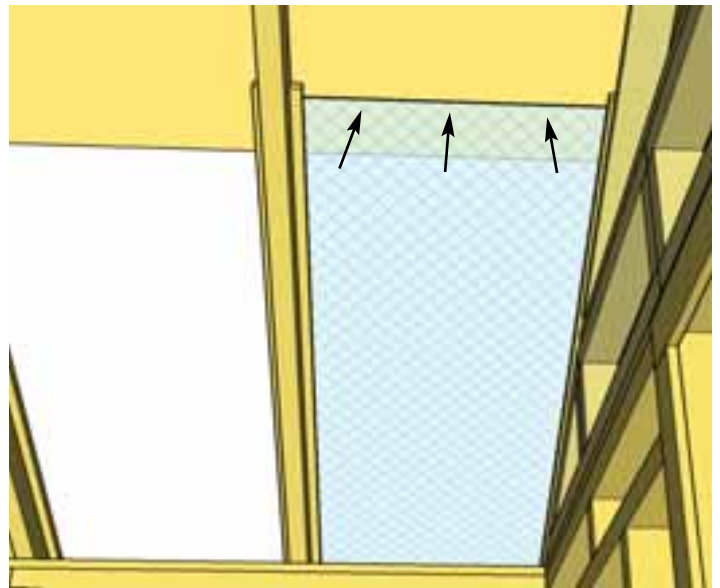
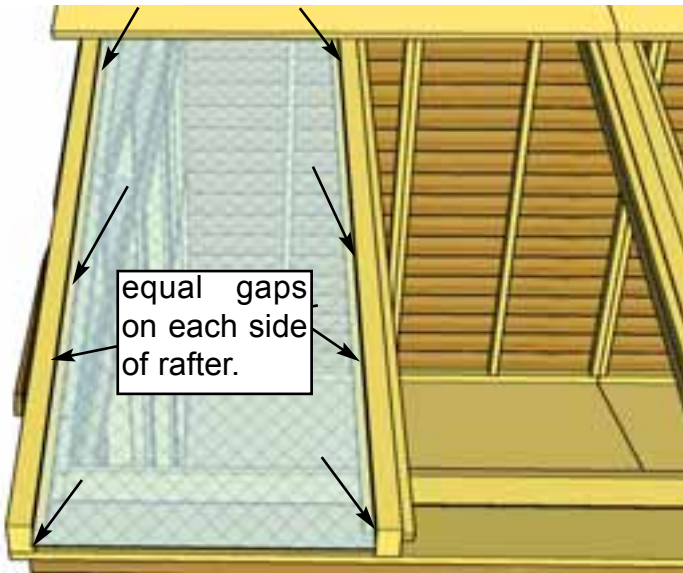

**D10.** Drill pilot holes with 1/8" bit through Polygal Panel and Polygal Support Cleats. Once aligned, with 6 - 1" Screws, secure panel to Polygal Support Cleats. Polygal is delicate, tighten screws a half turn at a time so screws are flush with top of Polygal Panel. Use 3 - 1" Screws to secure Polygal Panel to underside of Roof Plywood.

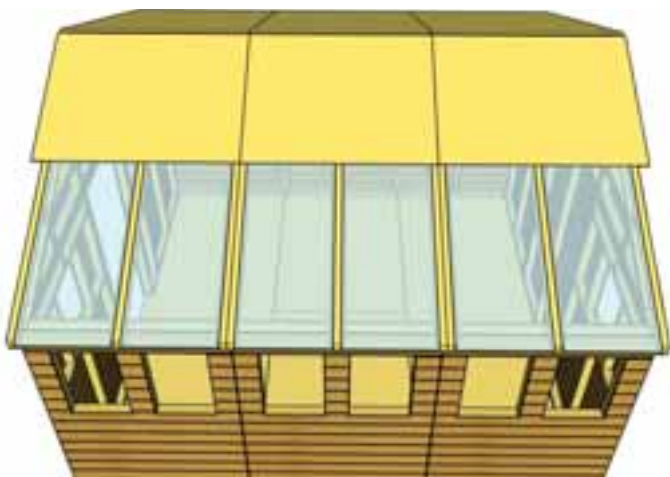

**D11.** Position and secure remaining Polygal Panels as per Steps D9 - D10. With a caulking gun, apply silicone to seal gaps between Rafters and Polygal Panels. Apply silicone down each side of Rafter. Use liberal amounts to properly seal.

# E. Miscellaneous Section

Exploded view of all parts necessary to complete the Skirting, Trim, Fascia and Miscellaneous Pieces. Identify all parts prior to starting.

**Expert Advice:** When installing trim, sort pieces according to color and pieces that are most pleasing to the eye. Start with least visible side of shed and use the least desirable pieces first. Install trim to most visible side of shed as your skill installing trim improves.

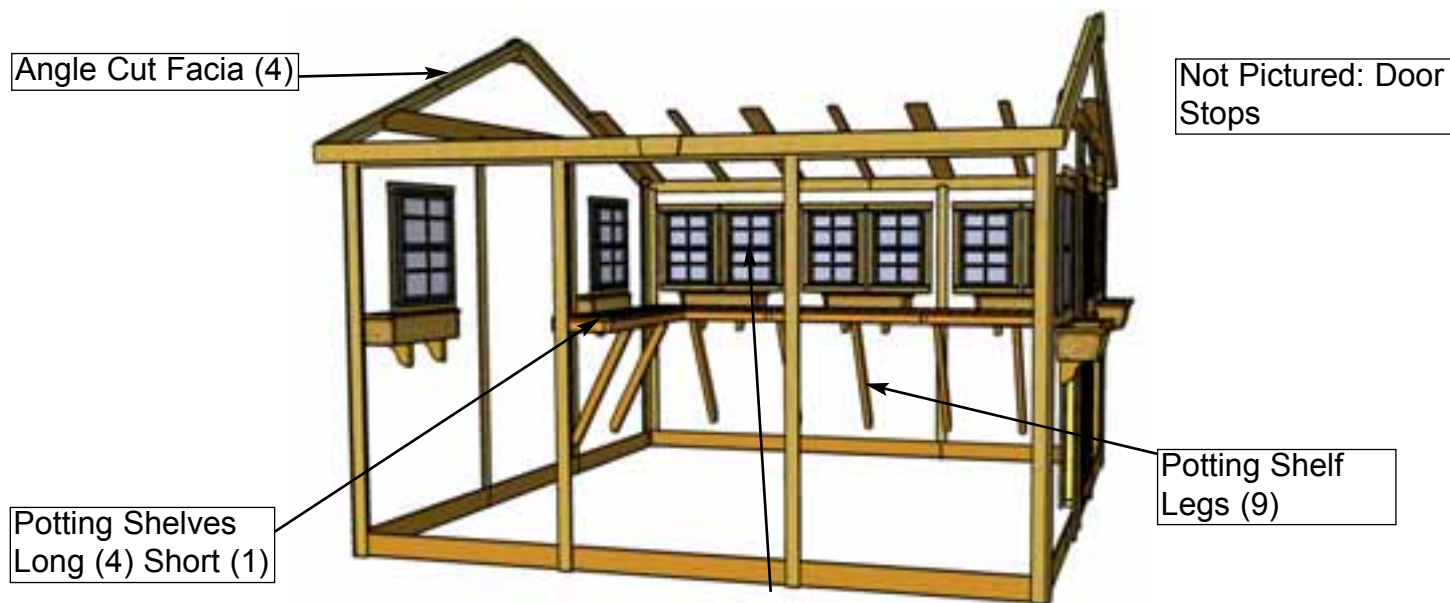
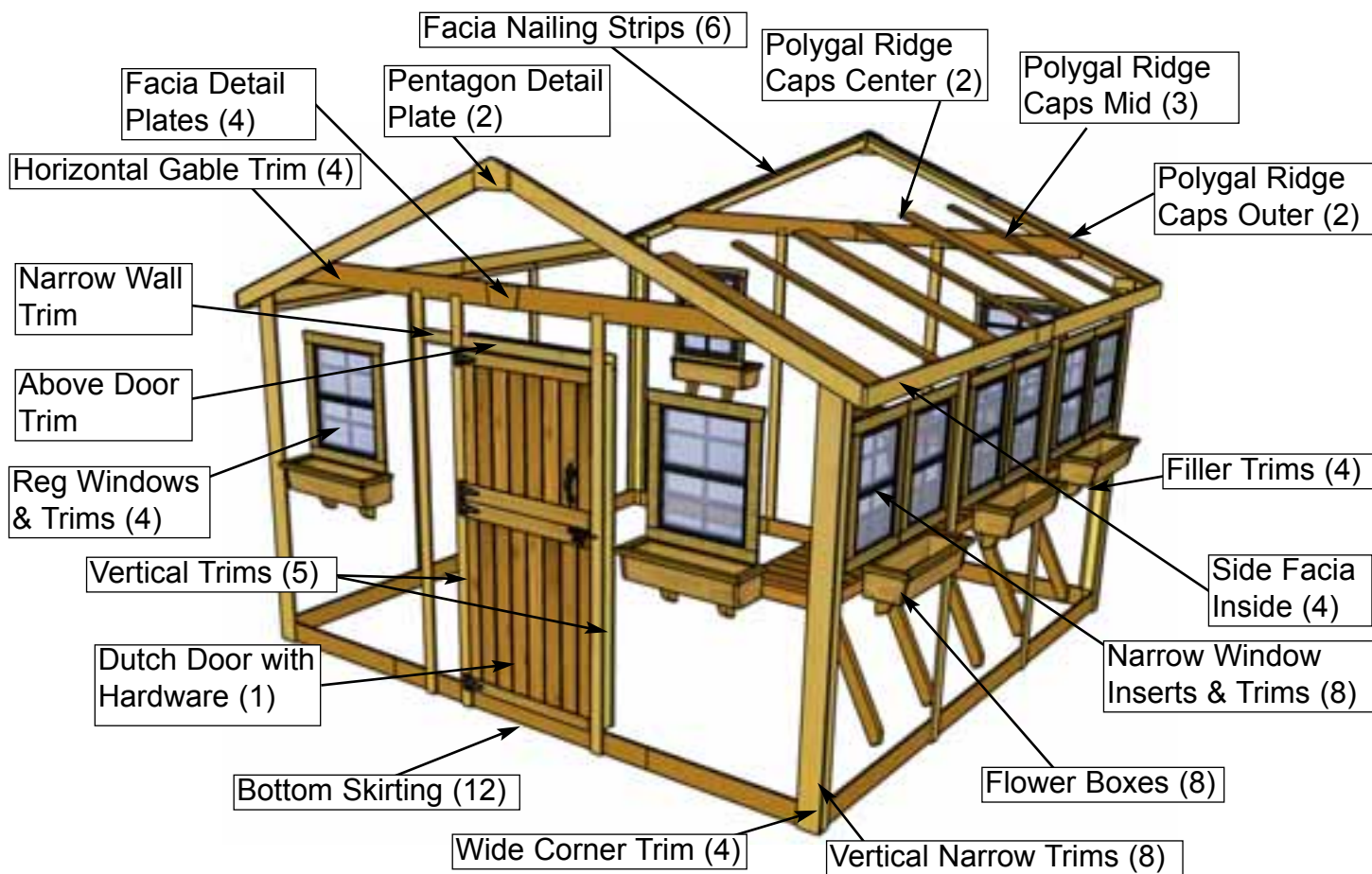

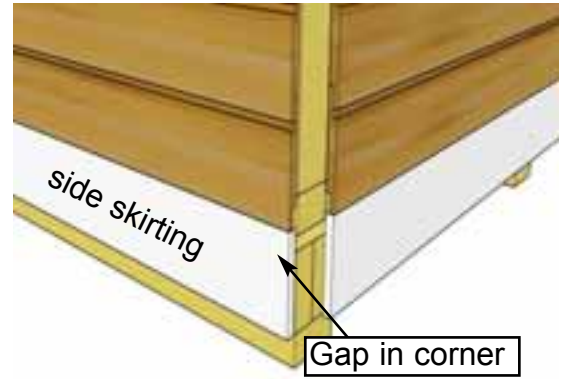

**E1.** Attach **Bottom Skirting** around the base of the shed. Skirting will hide floor framing. Gaps on outside will be covered by Wide Trim pieces later. Start with front and rear skirting pieces first and attach with 4 - 1 1/2" **Finishing Nails** per piece. Position with thick end of bevel upwards.

<u>Parts</u> <b>Bottom Skirting</b> (1/2" x 4 1/2" x 45 1/4") x 12	<u>Hardware</u> <b>1 1/2" Finishing Nails</b> x 48 total
--	--



**E2.** Check the wall seams for visible gaps prior to attaching filler trim and apply caulk where needed. Caulking gaps will help prevent moisture from entering and will help the longevity of your shed. Caulking is included to complete Polygal Windows only. Additional Caulking may be required for gaps.

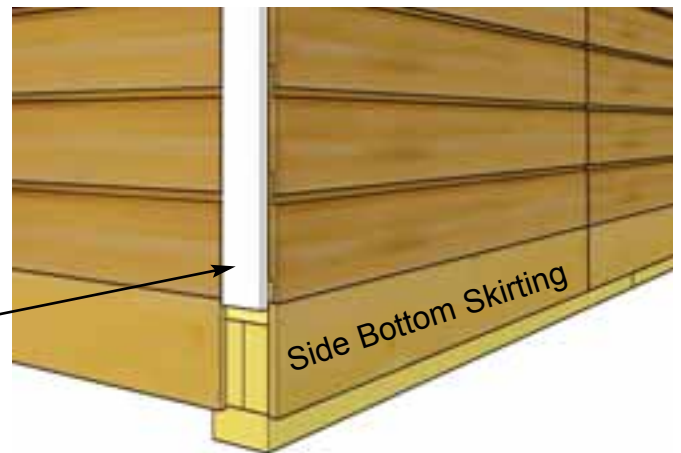

**E3.** Attach **Filler Trim** to front and rear walls in each corner. Attach with 8 - 1 1/2" **Finishing Nails** per piece. Strips are positioned flush with siding and bottom skirting.

<u>Parts</u> <b>Filler Trim</b> (3/4" x 2 1/2" x 75") x 4	<u>Hardware</u> <b>1 1/2" Finishing Nails</b> x 32 total
---	--

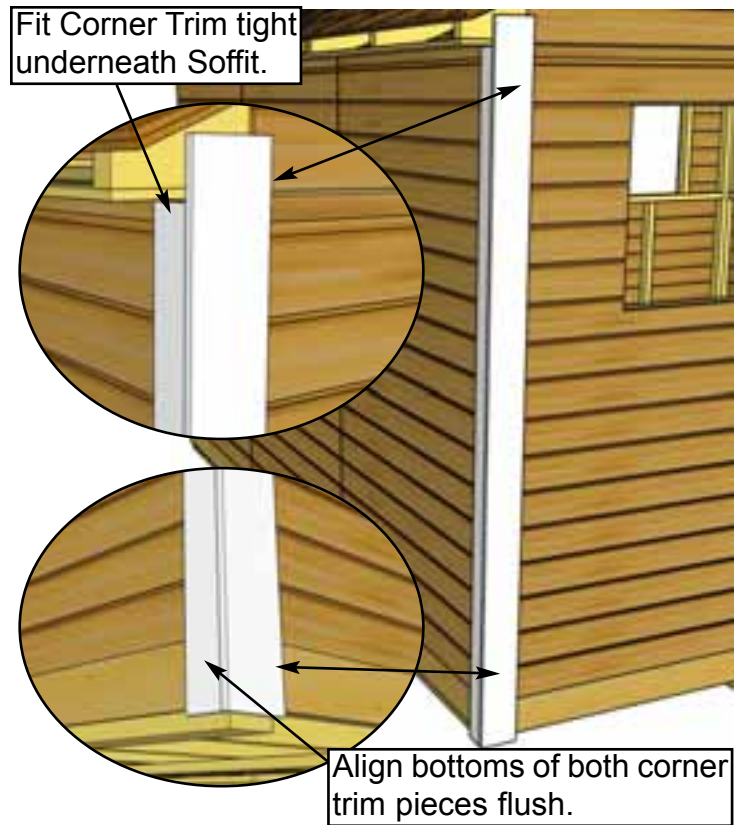
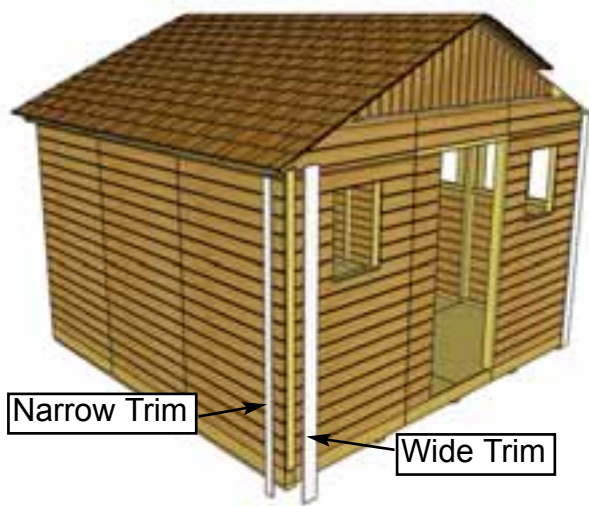

**E4.** Attach **Wide Corner Trim** and **Vertical Narrow Trim** in each corner. Begin with **Narrow Trim** on side of shed, aligning tight underneath Soffit and even with front of filler trim. **Wide Trim** will cap **Narrow**, as shown in **Step E5**. Note that trim may sit slightly below **Bottom skirting** when correctly aligned.

<p><u>Parts (Steps E4 - E6)</u>  <b>Vertical Narrow Trim</b>          (1/2" x 2 1/2" x 79") x 8  <b>Wide Corner Trim</b>          (1/2" x 4 1/2" x 82") x 4</p>	<p><u>Hardware (Steps E4 - E6)</u>  <b>1 1/2" Finishing Nails</b>          x 96 total</p>
---	---

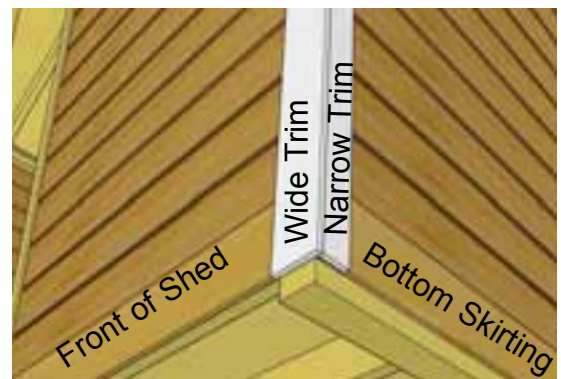
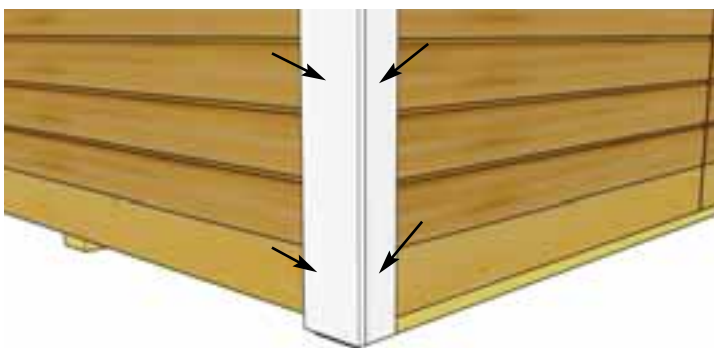

**E5.** When correctly aligned, attach with **8 - 1 1/2" Finishing Nails** per piece. Complete remaining **Corner Trim** attachments.



**E6.** Attach **Vertical Narrow Trims** around the Sunshed. Narrow Trims are used where wall panels come together and leave a seam. Attach with **8 - 1 1/2" Finishing Nails** per piece.

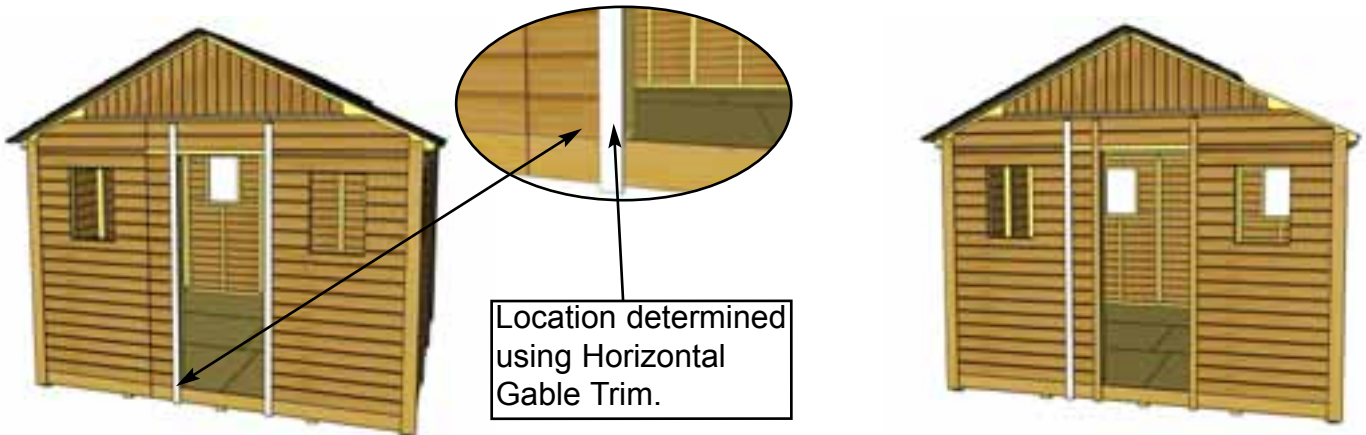

**E7.** Position 2 **Door Trims** on each side of door opening. Right side will sit flush with Door Jamb. Left side will sit flush on edge of Narrow wall. Do a dry run with the Horizontal Gable Trim (**Step E11**) to determine vertical location of Trims. Position another Vertical Trim on Narrow Wall Seam. Attach each piece with **8 - 1 1/2" Finishing Nails**.

<p><u>Parts (Step E8 - E9)</u>  <b>Vertical Trim</b>          (1/2" x 2 1/2" x 87") x 5</p>	<p><u>Hardware (Step E8 - E9)</u>  <b>1 1/2" Finishing Nails</b>          x 40 total</p>
---	--



**E8.** Continue around the Sunshed and attach Vertical trims at the rear with **8 - 1 1/2" Finishing Nails** per piece.



**E9.** Locate **Horizontal Gable Trims** for both front and rear of shed. Position equally over gable and wall seam and attach with **6 - 1 1/2" Finishing Nails** per piece.

<u>Parts</u> <b>Horizontal Gable Trims</b> (1/2" x 4 1/2" x 58 1/2") x 4	<u>Hardware</u> <b>1 1/2" Finishing Nails</b> x 24 total
--	--



**E10.** Attach both the **Horizontal Door Trim (32")** with **4 - 1 1/2" Finishing Nails**, and **Horizontal Narrow Wall Trim (8")** with **2 - 1 1/2" Finishing Nails**.

<u>Parts</u> <b>Horizontal Door Trim</b> (1/2" x 2 1/2" x 32") <b>Horizontal Narrow Wall Trim</b> (1/2" x 2 1/2" x 8")	<u>Hardware</u> <b>1 1/2" Finishing Nails</b> x 6 total
--	---

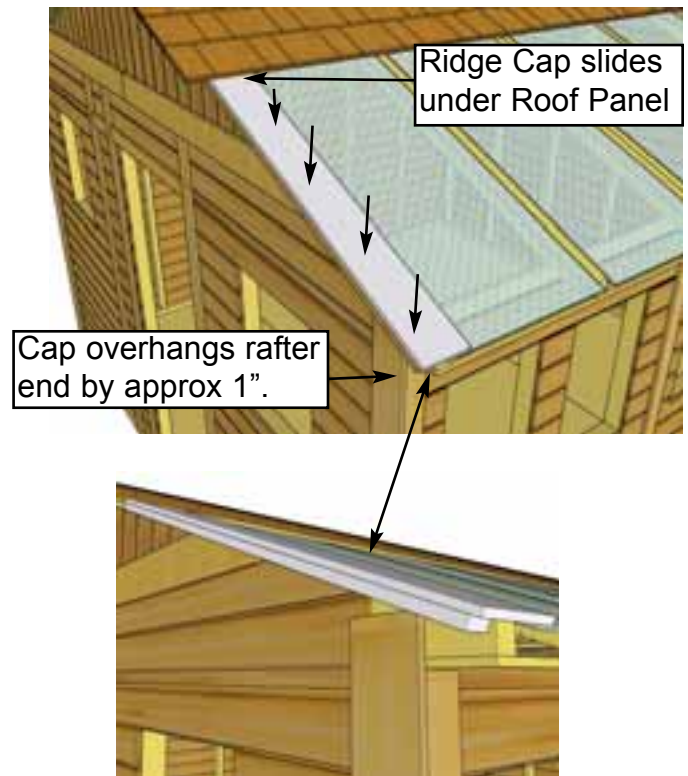
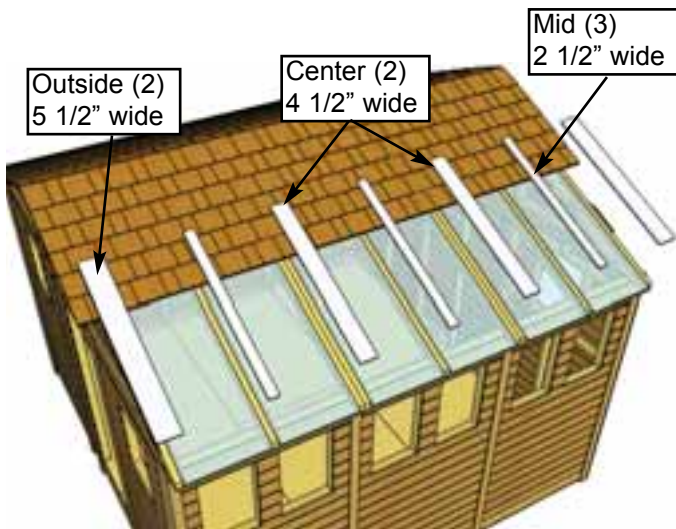

**E11.** Locate all Ridge Caps for Polygal (3 Mid / 2 Outside / 2 Center). Starting from the outsides, position both 5 1/2" wide caps so the long edge with the pre-attached fascia cleat is aligned with plywood of roof, and Cap end slides under roof. When correctly aligned, attach Caps to center of outside rafter with 4 - 1 1/2" Finishing Nails. Use a straight edge to align Cap with Roof Plywood. See below.

<p><u>Parts (Steps E12 - E14)</u></p> <p><b>Outside Ridge Caps (Facia Cleat Attached)</b> (1/2" x 5 1/2" x 44") x 2</p> <p><b>Mid Ridge Caps</b> (1/2" x 2 1/2" x 44") x 3</p> <p><b>Center Ridge Caps</b> (1/2" x 4 1/2" x 44") x 2</p>	<p><u>Hardware (Steps E12 - E14)</u></p> <p><b>1 1/2" Finishing Nails</b> x 28 total</p>
--	--

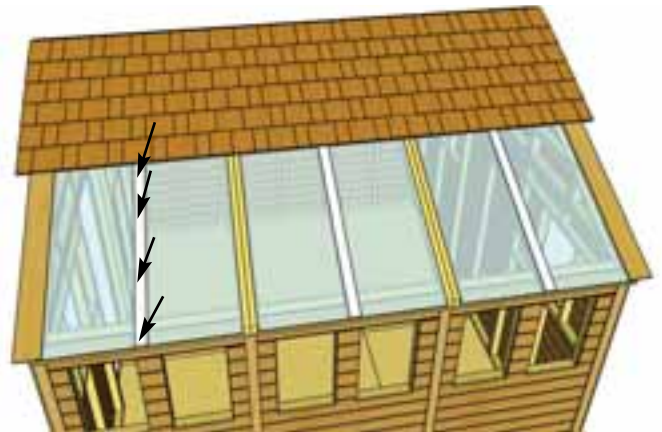
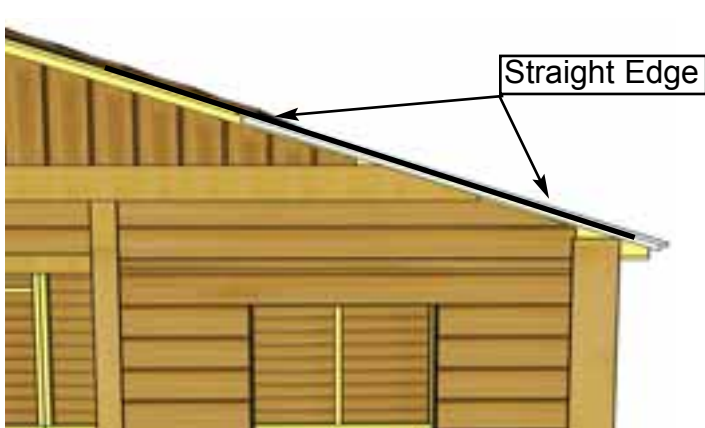

**E12.** Position and attach Mid Ridge Caps, evenly spaced on mid Rafters. Align top to bottom as per Step E11.



**E13.** Align and attach remaining Ridge Caps (4 1/2" wide) over Double Rafters as per Step E12.



**E14.** Attach Fascia Nailing Strip (36 1/2") centered on underside of Short Roof plywood, flush to edge. Attach Fascia Nailing Strips (40") to underside of Long Roof plywood, 1/2" from ends and flush to edge. Repeat this step on the rear side of shed. Fasten with 3 - 1 1/4" Screws per piece.

Parts	Hardware
<p><b>Fascia Nailing Strip</b> (3/4" x 1 1/2" x 36 1/2")</p> <p><b>Fascia Nailing Strip</b> (3/4" x 1 1/2" x 40")</p>	<p><b>1 1/4" Screws</b> x 18 total</p>

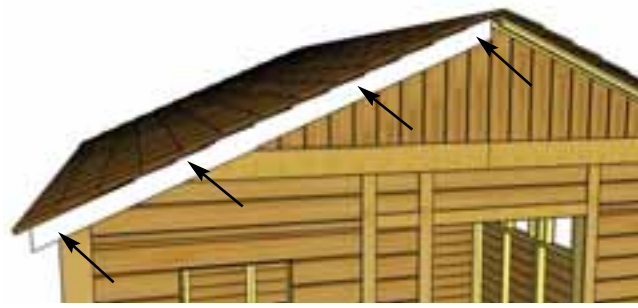

Do a dry run, lining up Front/Rear/Side Facia to confirm positioning prior to attaching.

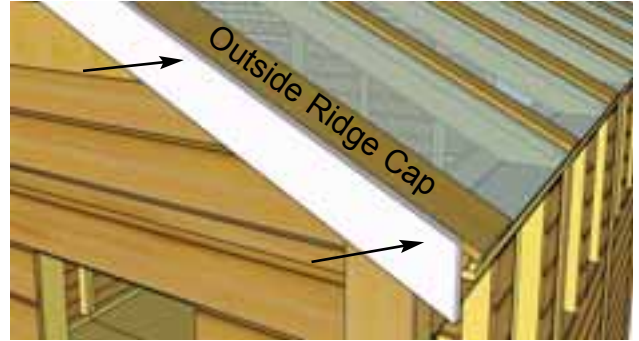
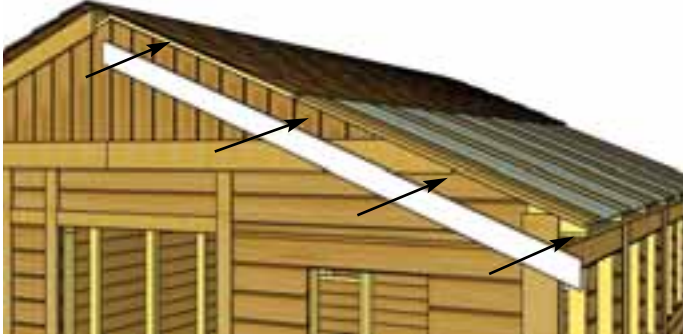

**E15.** Attach **Front and Rear Facia** (angle cut on ends), to **Facia Cleats** and **Outside Ridge Cap** with **10 - 1 1/2" Finishing Nails** and **2 - 1 1/4" Screws** on long roof side. Line up so **Facia end** lines up with **Plywood** and **Rafter ends**. Attach **Front and Rear Facia** (angle cut on ends), to **Facia Cleats** with **10 - 1 1/2" Finishing Nails** per piece on short roof side. Do a dry run with **Front and Rear** and **Side Facia** to confirm correct positioning prior to attaching.

<p><u>Parts</u>  <b>Front &amp; Rear Facia (Angle Cut Ends)</b>          (3/4" x 3 1/2" x 82 1/8") x 4</p>	<p><u>Hardware</u>  <b>1 1/2" Finishing Nails</b>          x 40 total  <b>1 1/4" Screws</b>          x 4 total</p>
--	--

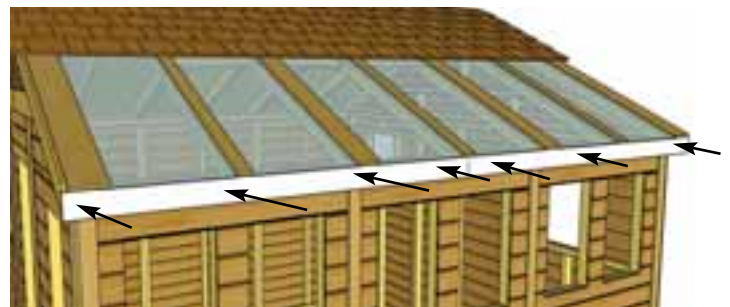

**E16.** Attach **Side Facia** to roof rafter ends. There are 2 **Side Facia** pieces per side. Secure with **8 - 1 1/2" Finishing Nails** per piece. **Side Facia** will sandwich **Front and Rear Facia**.

<p><u>Parts</u>  <b>Side Facia</b>          (3/4" x 5 1/2" x 71 3/4") x 4</p>	<p><u>Hardware</u>  <b>1 1/2" Finishing Nails</b>          x 32 total</p>
---	---



**E17.** Attach **Pentagon Plates** to cover seams where **Facia Trim** pieces come together. Secure each with 4 - 1 1/2" **Finishing Nails**.

<u>Parts</u> <b>Pentagon Facia Plates</b> x 2	<u>Hardware</u> <b>1 1/2" Finishing Nails</b> x 8 total
---	---

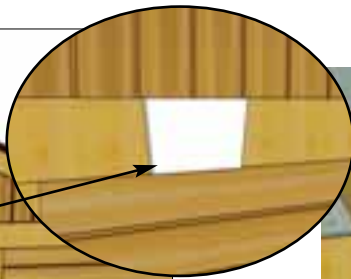
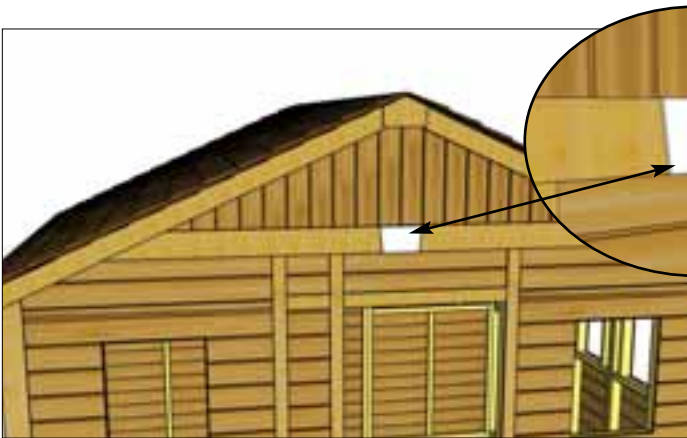

**E18.** Attach **Facia Detail Plate** to side facia where they meet in the middle. Use 4 - 1 1/2" **Finishing Nails** per piece to secure. Complete both sides. Attach **Horizontal Gable Detail Plates** to cover seams where **Horizontal Gable Trims** meet. Secure with 4 - 1 1/2" **Finishing Nails** per piece.

<u>Parts</u> <b>Facia Detail Plates</b> (3 1/2" High") x 2 <b>Facia Detail Plates</b> (4 1/2" High") x 2	<u>Hardware</u> <b>1 1/2" Finishing Nails</b> x 16 total
--	--

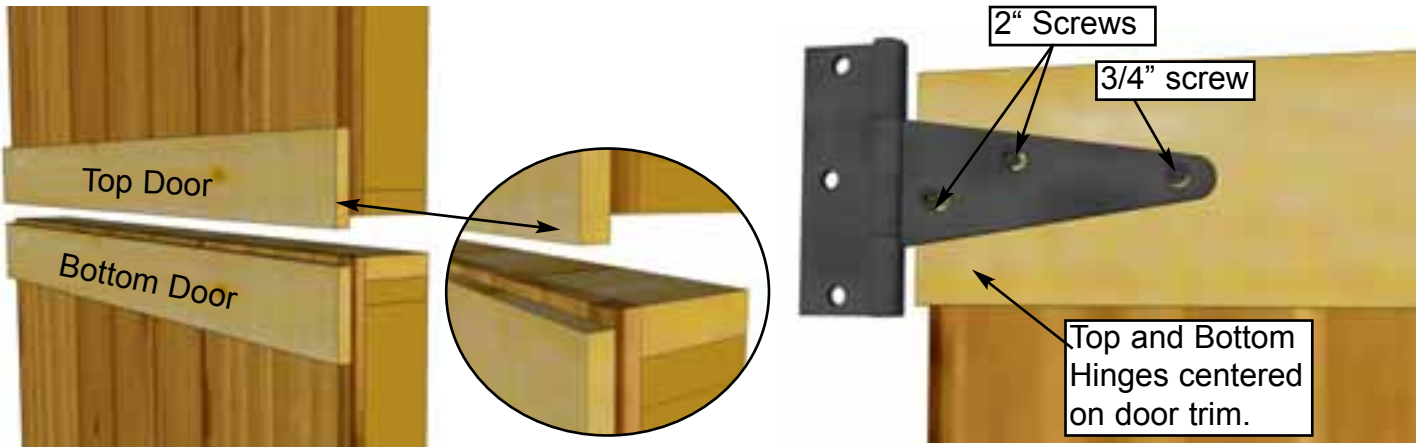

**E19.** Attach Door Hinges to **Top** and **Bottom Dutch Door** sections. Top Door section has middle trim overhanging door at bottom while bottom door section has middle trim recessed slightly. Top and Bottom Hinges should be centered on door trim. Align the middle hinge for the top door section closer to the top of the middle door trim. Align the middle hinge for the bottom door section closer to the bottom of the middle door trim. Middle hinges should not overlap. Position middle hinges accordingly. Use **2" & 3/4" Black Headed Screws** as shown above.

Parts (Steps E20 - E22)	Hardware (Steps E20 - E22)
<b>Dutch Door - Top</b> (31 1/2" x 30") x 1	<b>Tee Hinges</b> x 4 total
<b>Dutch Door - Bottom</b> (31 1/2" x 42") x 1	<b>3/4" Black Screws</b> x 4 total
	<b>2" Black Screws</b> x 20 total

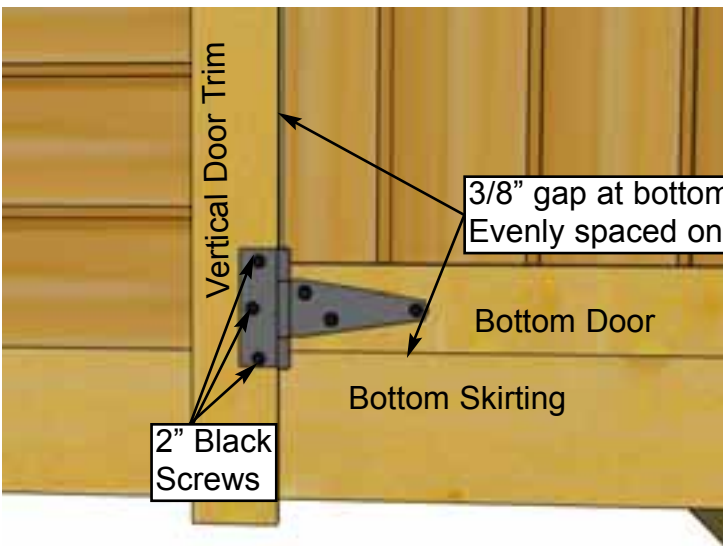
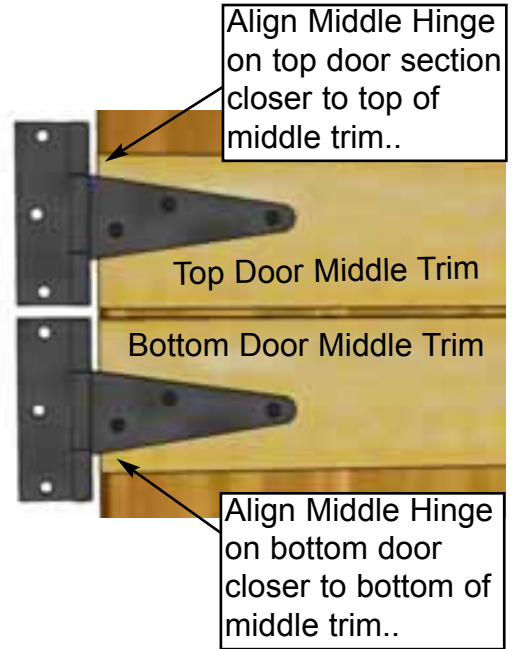

**E20.** Place Bottom Dutch Door panel into position. Gap 3/8" on bottom, evenly space on sides, and attach hinge to doorway seam trim with **2" Black Headed Screws**. Use shim to help keep the door evenly spaced on bottom. One of the extra roof shingles (see parts list) can be used.



**E21.** Place the Top Dutch Door Panel into place and gap top and bottom trims on the outside about 1/8" apart. On the inside, horizontal door frames should be about 1/4" apart. Use a shim once again to help you. Attach hinges to trim with **2" Black Headed Screws** provided.

**Important:** Drill pilot holes with 1/8" drill bit prior to securing with screws to prevent wood splitting. On 3/4" screw, drill shallow pilot hole only.



**E22.** Attach **Door Handle** and **Exterior Black Drop Latch** to door. Handle is positioned on top door, Drop Latch on bottom door. Attach Black Drop Latch as illustrated above with **2" & 3/4" Black Screws**. Note how female part of Drop Latch is positioned higher than male. Do a dry run first to position Drop Latch correctly. Attach Handle with **3/4" Screws**, ensure screws connect with inner door stud. Attach Interior **Silver Barrel Bolt** to inside of door as illustrated above. Use **3/4" Silver Screws** to secure.

Hardware  
**Door Handle**  
**Drop Latch**  
**Silver Barrel Bolt**  
**3/4" Black Screws x 5 total**  
**2" Black Screws x 5 total**  
**3/4" Silver Screws x 6 total**

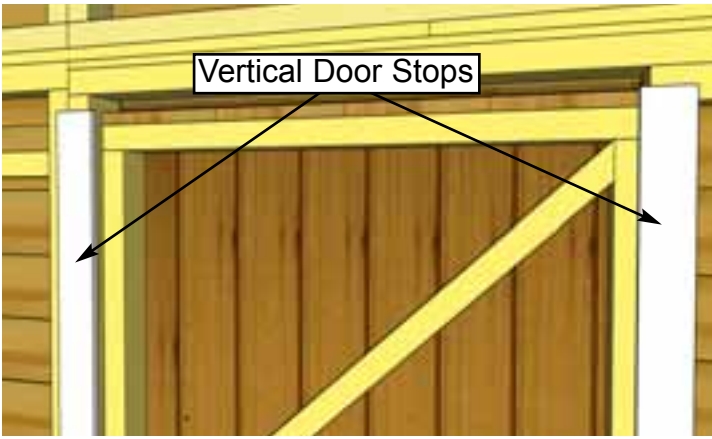

Vertical Door Stops

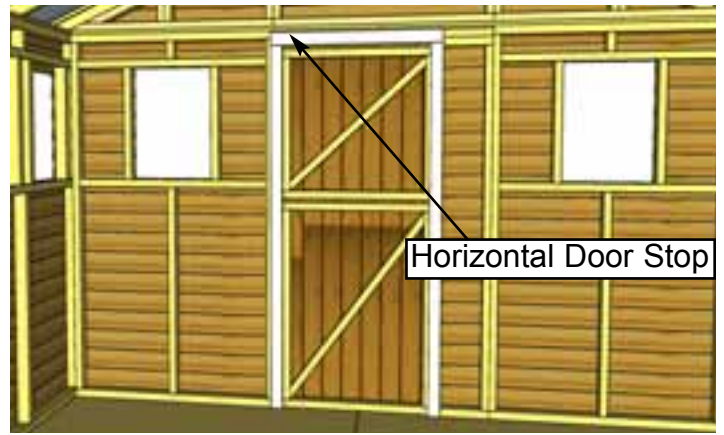

Horizontal Door Stop

**E23.** Attach Interior Vertical and Horizontal Door Stops to door framing from inside of shed. Use 4 - 2" Screws to secure each Stop. Stops should overlap door by approx. 1/2"

<p><u>Parts</u>  <b>Vertical Door Stops</b>          (1/2" x 2 1/2" x 72") x 2  <b>Horizontal Door Stop</b>          (1/2" x 2 1/2" x 36") x 1</p>	<p><u>Hardware</u>  <b>2" Screws</b>          x 12 total</p>
--	--

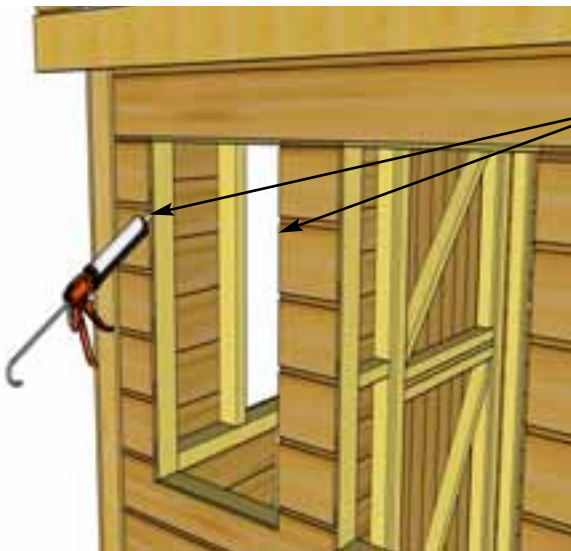

Caulk channel in siding on both sides of window.

**Note:** We recommend you wait to install the windows last, so they don't get damaged during construction.

**Important:** Lineup window insert in cavity and **pre-drill** holes into the filler strip at the top of the window.

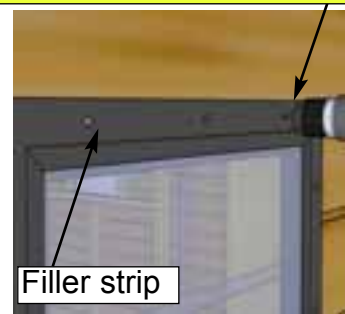
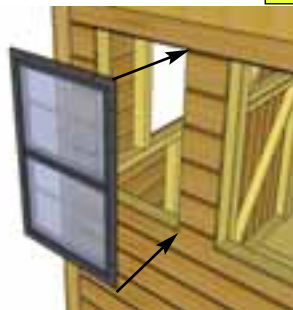

Filler strip

**E24.** Locate Window Inserts for Double Window Walls. Before installing, dab caulk in channel on both sides of window opening. This will prevent water from getting in behind window. Position window in cavity. **Important:** Pre-drill holes in filler strip at top of window with 1/8" drill bit before fastening window inserts. Secure with 8 - 1 1/4" Screws. Caulk gap between siding and window at top. This requires a large amount of caulking but is important to fill. Later, Window Trims will be installed to hide caulking. Complete for **Regular Window Walls**.

<p><u>Parts</u>  <b>Small Window Inserts x 6</b>  <b>Regular Window Inserts x 4</b></p>	<p><u>Hardware</u>  <b>1 1/4" Screws</b>          x 80 total</p>
---	--

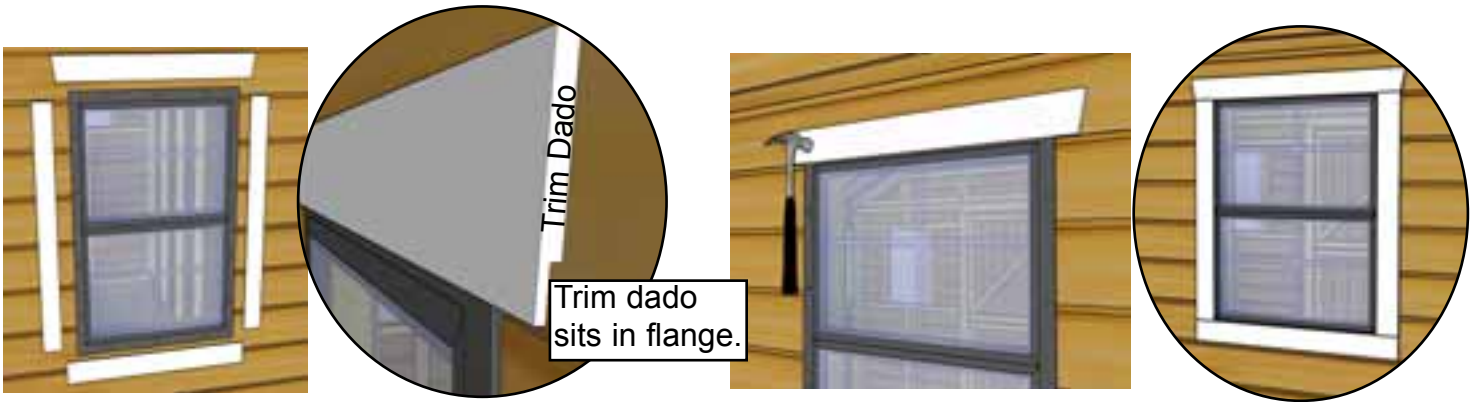

Trim Dado  
Trim dado sits in flange.

**E25.** Position Window Trim around window doing a dry run first and attach with **4 - 1 1/2" Finishing Nails** per piece. There are two Trim Kits (Regular / Narrow). The regular window kit = 1 x 24 1/16" = top (angle cut on ends) / 3 x 23" = Sides & Bottom. Narrow window kit = 1 x 19 7/8" Top, 2 x 21 7/16" Sides, 1 x 18 3/4" Bottom. Window trim has a small dado on reverse face. Outside flange of window will roughly sit in the dado to give a better fit.

<u>Parts</u>	<u>Hardware</u>
<p><b>Regular Window Trim Package x 4</b>            (Top - 24 1/16" Long - <i>Angle Cut Ends</i>) x 1            (Sides &amp; Bottom - 23" Long) x 3</p> <p><b>Narrow Window Trim Package x 6</b>            (Top - 19 7/8" Long - <i>Angle Cut Ends</i>) x 1            (Sides - 21 7/16") x 2            (Bottom - 18 3/4" Long) x 1</p>	<p><b>1 1/2" Finishing Nails</b>            x 160 total</p>



**E26.** Assemble **Flower Box Kit** with Assembly Instructions included on Page 68. Position completed Flower Box below bottom of window trim and secure with **2 - 2 1/2" Screws**. Screw from inside of box into the center wall stud. Attach second screw 2" underneath first screw and once again into the wall stud. Install Flower Box Kits underneath each window.

Hardware  
**2 1/2" Screws**  
 x 14 total

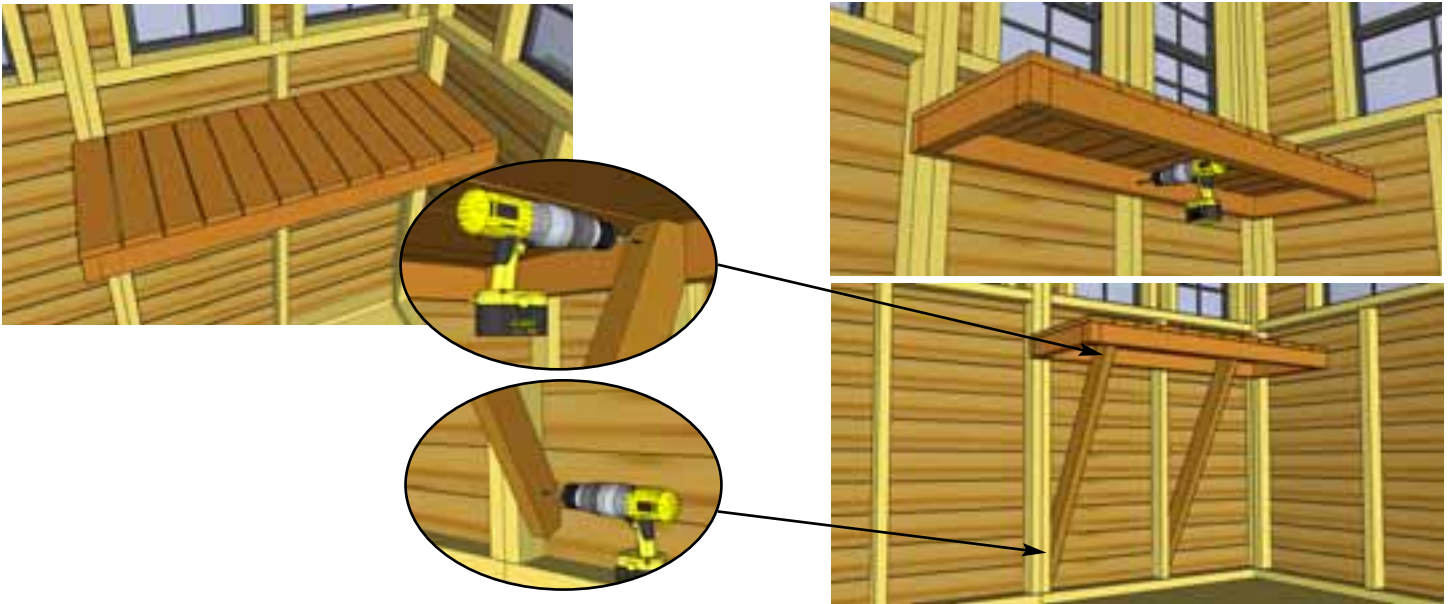

**E27.** Locate 1 Long Potting Shelf and 1 Leg. Position shelf in corner tight against wall framing. While supporting the shelf, attach shelf with 2 - 2 1/2" Screws. Place leg underneath shelf and attach to inside shelf frame and wall framing as illustrated above with 2 - 2 1/2" Screws.

<p><u>Parts (Steps 96 - 97)</u>  <b>Long Potting Shelves</b>          (16" x 45") x 3  <b>Short Potting Shelf</b>          (16" x 41") x 1  <b>Potting Shelf Legs</b>          (1/2" x 2 1/2" x 38") x 4</p>	<p><u>Hardware (Steps 96 - 97)</u>  <b>2 1/2" Screws</b>          x 16 total</p>
--	--

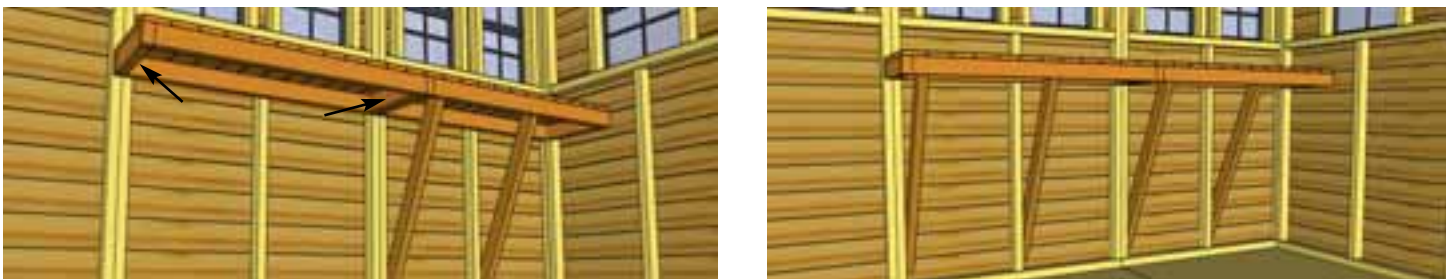

**E28.** Place Short Potting Shelf against wall framing and end of long shelf framing. Attach with 2 - 2 1/2 " Screws as per Step E28. Use a level to confirm shelving is square and level. Attach leg as previously illustrated. Screw to wall stud and up into the underside of the of shelf framing. Complete remaining long shelves as per Steps E27 & E28.



Completed Potting Shelf



# Outdoor Living Today Flower Box Assembly Instructions

## Parts Lists:

<b>A - Base, Rear &amp; Front Box Frames (3pcs)</b>	$3/4" \times 5 1/2" \times 23"$
<b>B - End Cap Frames (2pcs)</b>	$3/4" \times 5 1/2" \times 7" / 8"$
<b>C - Front Trim (1 pc)</b>	$3/4" \times 1 1/2" \times 26"$
<b>D - Side Trims (2 pc)</b>	$3/4" \times 1 1/2" \times 8 3/4"$
<b>E - Brackets (2 pc)</b>	$1 1/2" \times 5 1/2" \times 5 1/2"$
<b>F - 1 1/4" Screws (15 pc)</b>	(15 pc)
<b>G - 1 1/2" Nails (10 pc)</b>	(10 pc)

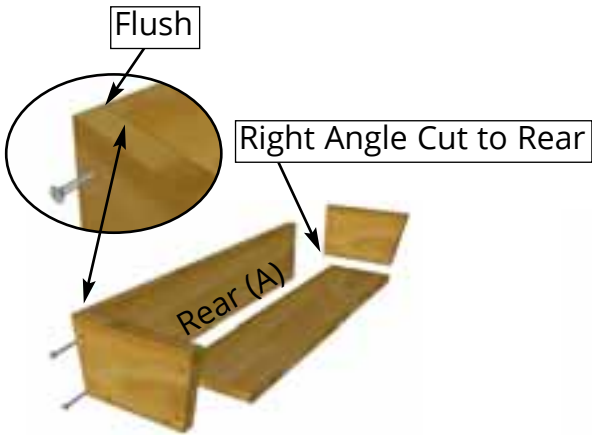
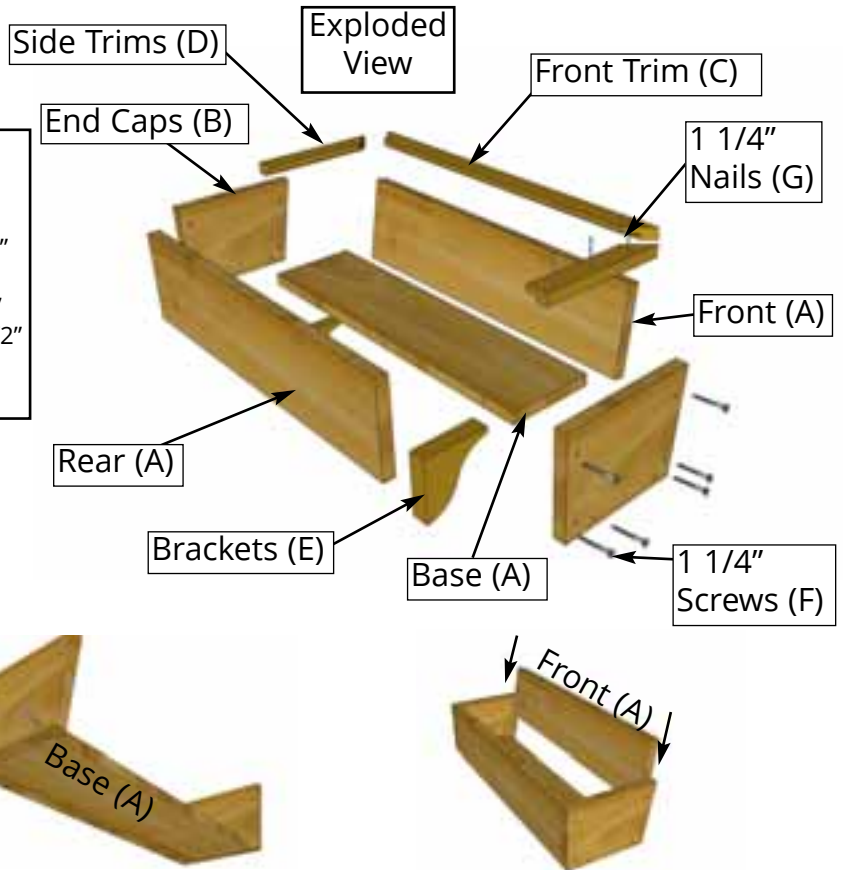

**1.** On a table position Rear Box and End Cap Frames together so flush at top. Fasten together with 2 - 1 1/4" screws. Place Base Frame tight against Rear and End Cap and flush at bottom. Secure with 2 - 1 1/4" screws. Complete attachment of remaining End Cap Frame. Slide Front Frame between End Caps.

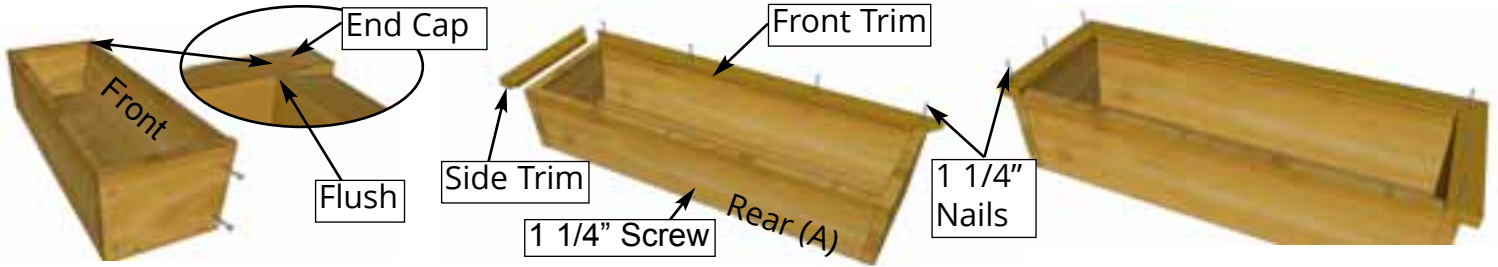

**2.** Position Front Frame Piece flush with End Cap. Attach both ends with 2 - 1 1/4" screws. Pilot hole Rear Box Frame near bottom center and secure to Base edge with 1 - 1 1/4" screw. Evenly position Front Trim (mitre cut on end and dado cut on inside bottom) tight against front frame and nail down with 4 - 1 1/4" nails. Position Side Trims as per Front and secure with 3 - 1 1/4" nails per side.

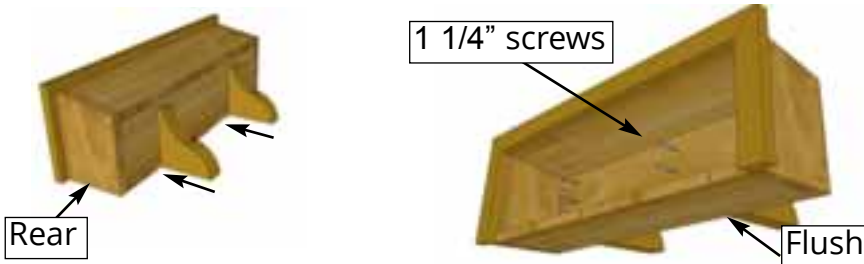

**3.** On a flat surface, flip Flower Box on it's rear face. Evenly space Brackets and secure through Base Frame and into the Brackets with 2 - 1 1/4" screws per Bracket. Position completed Flower Box beneath window trim and screw from inside of box into the center wall stud with 2 - 2" screws. (2" screws supplied with Base Kit.)



# Outdoor Living Today



Congratulations on assembling your 12x12 Sunshed!

**Note:** Our Sheds are shipped as an unfinished product. If exposed to the elements, the lumber will weather to a silvery-gray color. If you prefer to keep the lumber looking closer to the original color, we suggest that you treat the wood with a good oil base wood stain. You may also wish to paint your new shed rather than stain it. In both cases we recommend that you consult with a paint and stain dealer in your area for their recommendations.

We hope your experience constructing our **12x12 Sunshed** has been both positive and rewarding. We value your feedback and would like to hear back from you on how well we are doing in the following areas:

1. Customer Service
2. On Time Shipping
3. Motor Freight Delivery
4. Quality of Materials
5. Assembly Manual
6. Overall Satisfaction



The materials contained in this Assembly Manual may be downloaded or copied provided that ALL copies retain the copyright and any other proprietary notices contained on the materials. No material may be modified, edited or taken out of context such that its use creates a false or misleading statement or impression as to the positions, statements or actions.

Please call, write or email us at:

Canadian Address  
9393 287th Street  
Maple Ridge, British Columbia  
Canada V2W 1L1

United States Address  
P.O. Box 96  
Sumas, Washington  
USA 98295

Toll Line: 1.888.658.1658 | Fax: 1.604.462.5333 | [sales@outdoorlivingtoday.com](mailto:sales@outdoorlivingtoday.com)