

Assembly Instruction

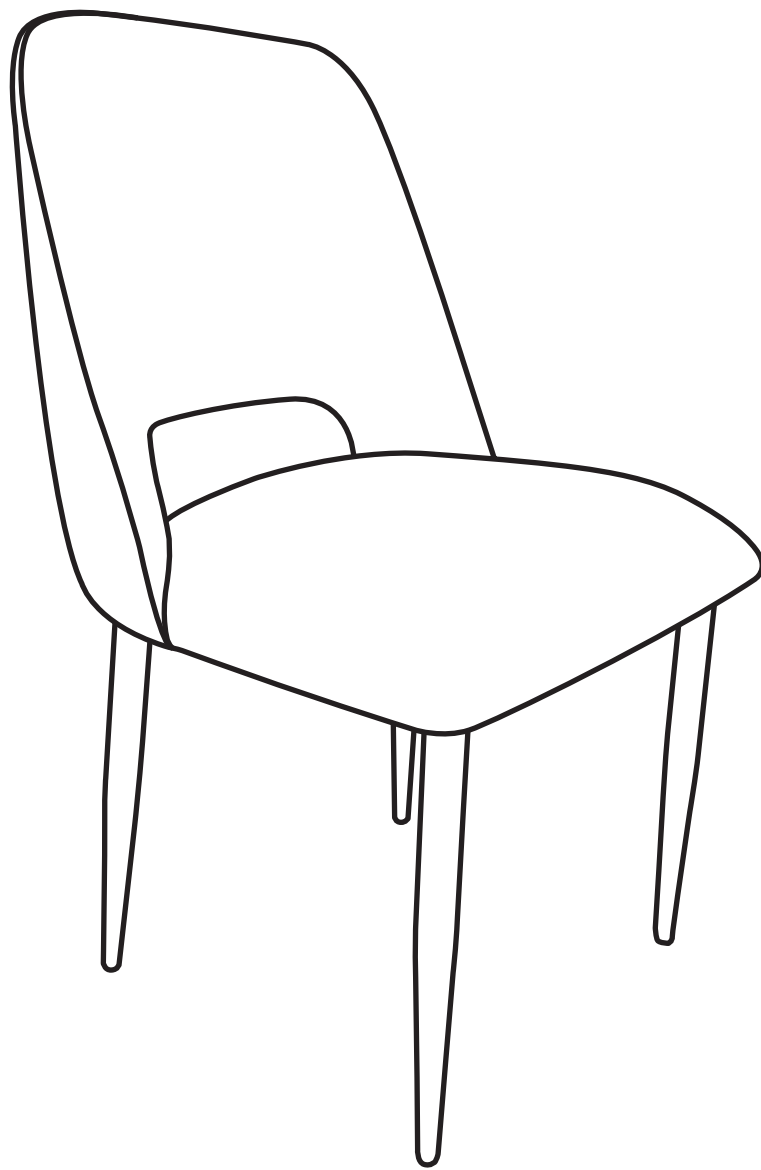

Guide of Manual

- Thanks for your choice. **We will do our best to provide customer service for everyone.**
- Please check to make sure all parts are included as stated when you unpack. If there are parts missing or wrong, please contact us, **we will expeditiously provide reissue accessories, compensation or other services.**
- Instruction should be read carefully. But the manual may not cover every detail of all possible situations and steps. **Please contact us if further information and help are needed. We will respond in a timely manner.**
- **Please be patient that the other items are on the way if you buy more than one product.**

Warning

- It's kindly advised to assemble this product on a carpeted floor to protect it from being scratched.
- Small parts are included. Please keep the product away from children while assembling. Do not let children play or jump on the product. Do not stand on the item or use as a step ladder.
- Please pay attention to the sharp corners during assembly. We recommend the use of gloves to prevent the undesired injury.
- Prior to use, please check to see if there's any loosening screw or part. Make sure that each screw and part is correctly installed and securely fastened.
- It's unnecessary to use electric drill. Please at a low gear if you need.

Care and Maintenance

- Use a soft, clean cloth that will not scratch the surface when dusting.
- There' s no need to use furniture polish. If you need, test it first in an inconspicuous area. Using solvents of any kind on your furniture may damage the finish. Never use water to clean your furniture as it may cause damage to the finish.
- Liquid spills should be removed immediately. Gently blot the spill with a soft clean cloth to avoid rubbing.

Further Advice about the Furniture Care

- It is best to keep your furniture in a climate-controlled environment.
- We recommend to keep furniture from sunlight exposure to avoid possible surface damage.
- Following these important and helpful tips will help retain your furniture's performance even when it ages.
- Periodically (every 90 days) make sure the screws are fully tightened.

Max Weight Capacity

- 300lbs [Do not stand on the item]



Parts and Hardware List:

o Make sure all the parts are in the package

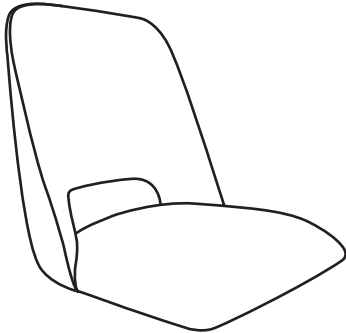
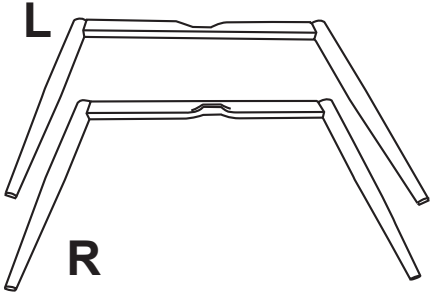
Part List:

<p>(A) Seat</p> 	<p>(B) Leg*2pcs</p> 
--	---

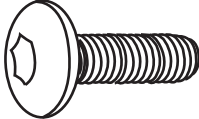
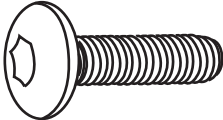
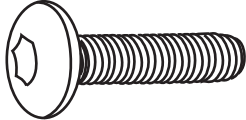
Hardware List:

<p>(C) Bolt M6*30*1pcs</p> 	<p>(D) Bolt M6*50*2pcs</p> 	<p>(E) Bolt M6*60*2pcs</p> 
<p>(F) Allen Key M6</p> 		

Step 1

Step1: Place the **(B) Leg*2pcs** in the position like the figure below. Use **(C) Bolt M6*30*1pc** to fasten them (tighten to 80%).

(B) Leg*2pcs

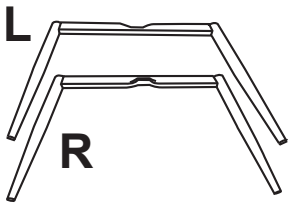

(C) Bolt M6*30*1pc

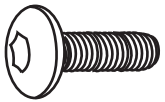

(F) Allen Key M6

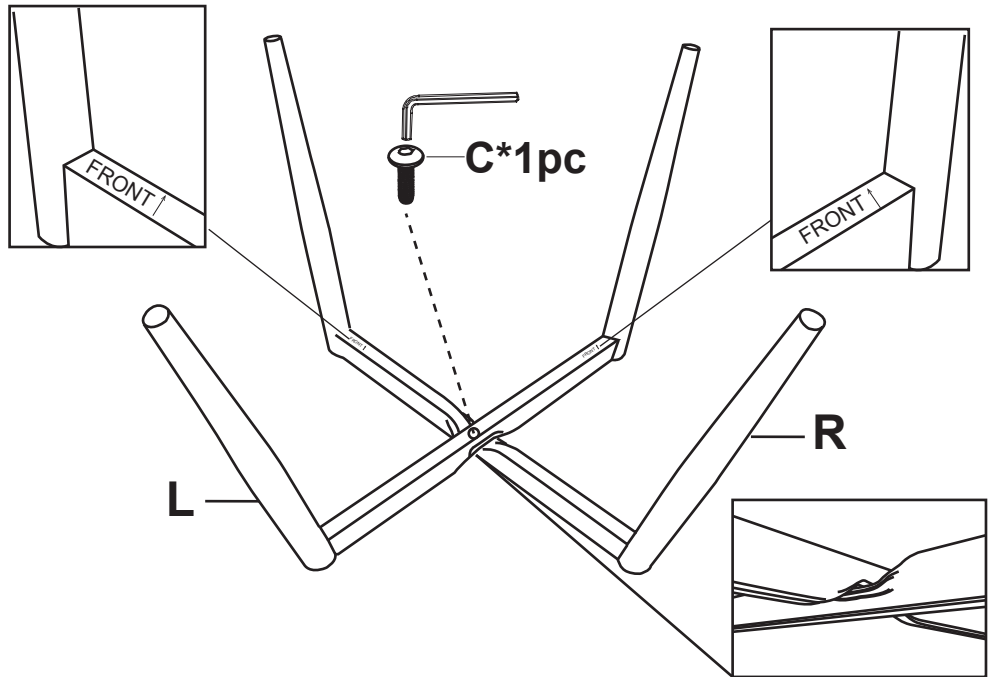

Step 2

Step2: Align the holes of the **(B) Leg*2pcs** with the **(A) Seat**, use **(D) Bolt M6*50*2pcs** and **(E) Bolt M6*60*2pcs** to fasten them. Tighten all bolts to 100%.

(A) Seat



(D) Bolt M6*50*2pcs

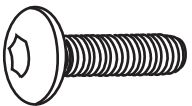

(E) Bolt M6*60*2pcs

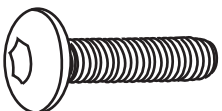

(F) Allen Key M6

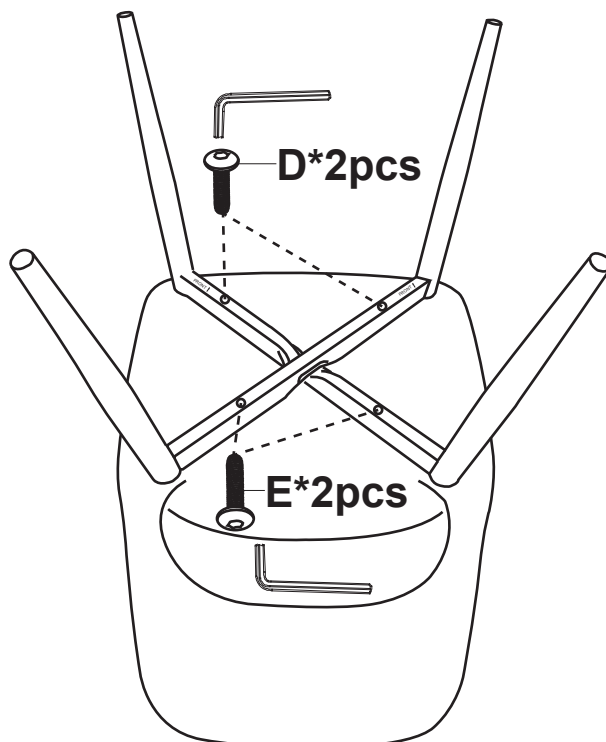
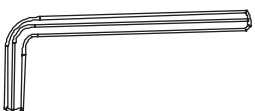

Finished

Done! Enjoy your new dining chair!

