

WARRANTY

We strive to offer high-quality products, and we also try our best to satisfy each and every customer that orders from us with product or service as needed. We provide 30 days warranty starting from the time you receive the item. Each customer must provide a record of their order such as the order number, or item receipt for any items that are out of the warranty period you may also still receive replacement parts by purchasing them with our company if they are available.

• Cautions

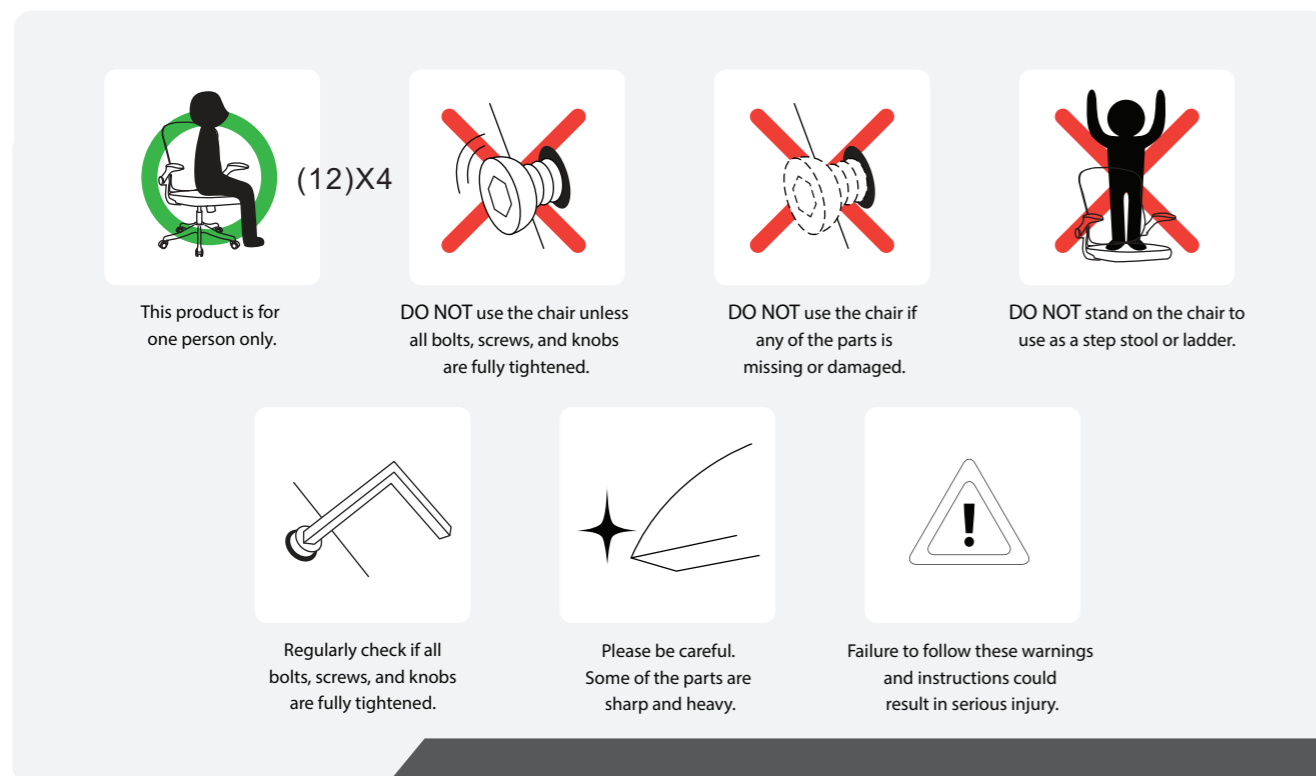

(12)X4

This product is for one person only.

DO NOT use the chair unless all bolts, screws, and knobs are fully tightened.

DO NOT use the chair if any of the parts is missing or damaged.

DO NOT stand on the chair to use as a step stool or ladder.

Regularly check if all bolts, screws, and knobs are fully tightened.

Please be careful. Some of the parts are sharp and heavy.

Failure to follow these warnings and instructions could result in serious injury.

MESH OFFICE CHAIR

ASSEMBLY INSTRUCTION

Contents

- Instructions
- Cautions

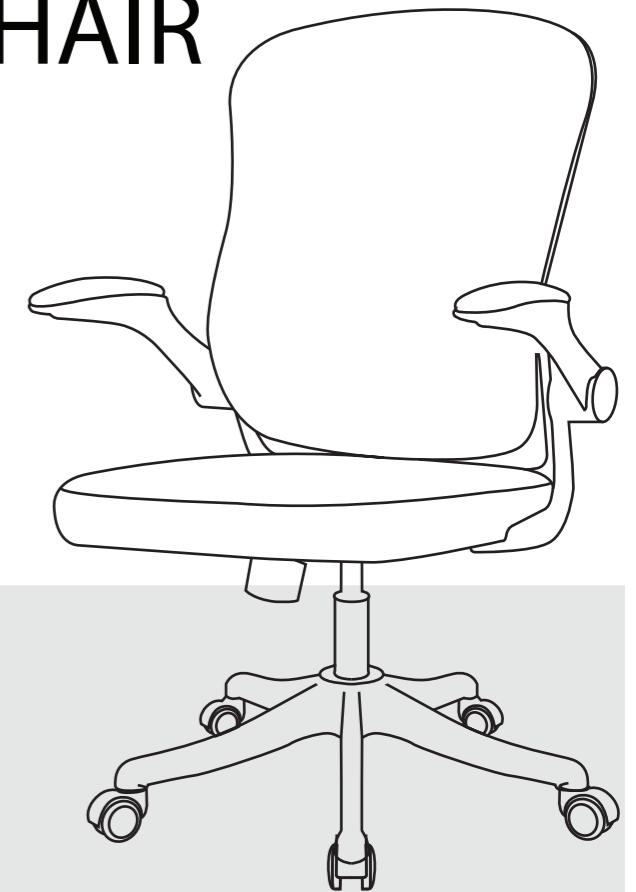

Please make sure all the parts are included.

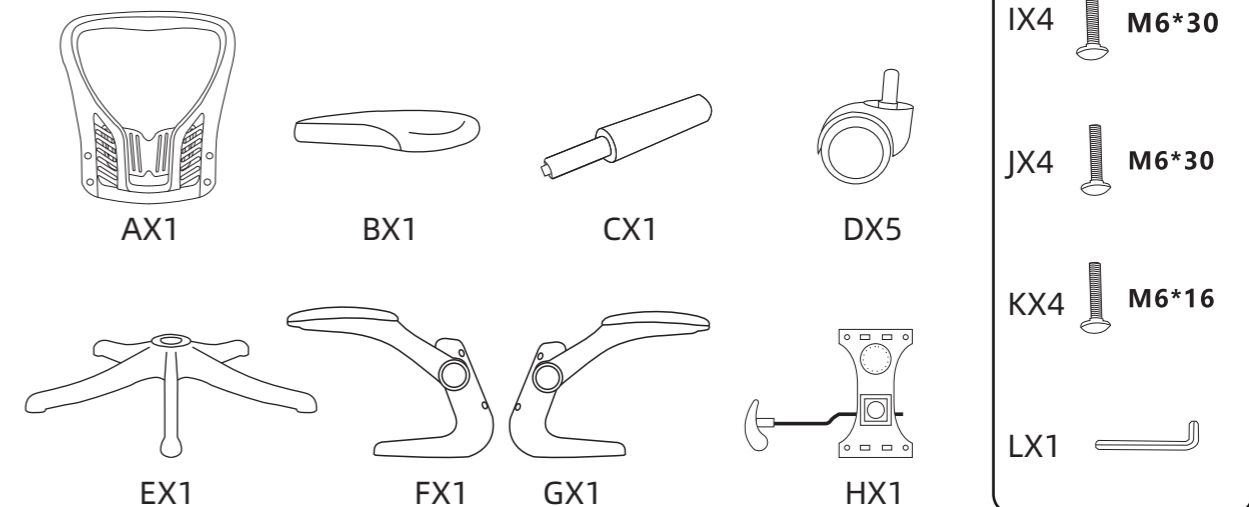

Read the instructions carefully.



Follow the assembly steps.

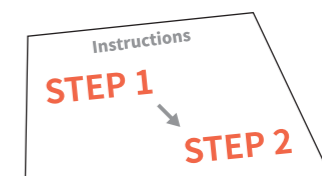

• Instructions

✘ NOTICE

Please use the allen key included instead of an electric drill.

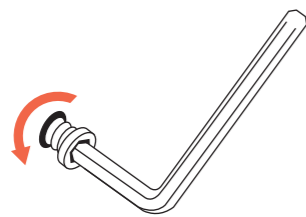

TIPS!

Use the box for an easier assembly.

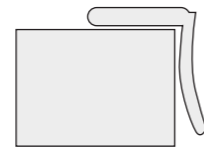

We recommend two people for the assembly process.



STEP 1

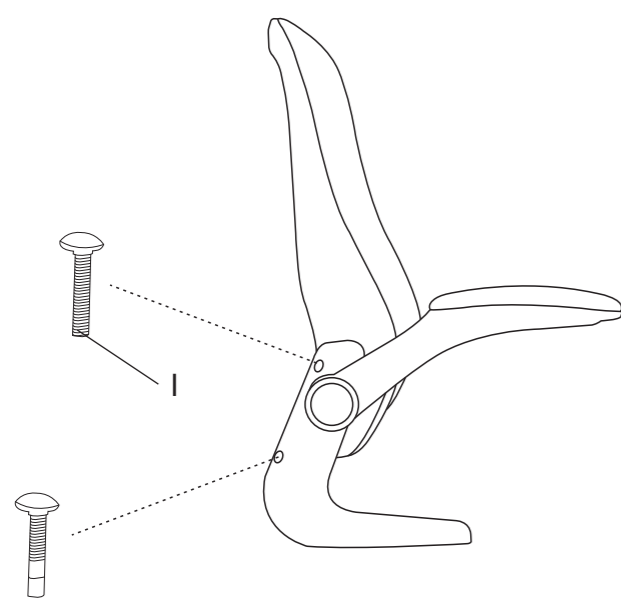

STEP 2

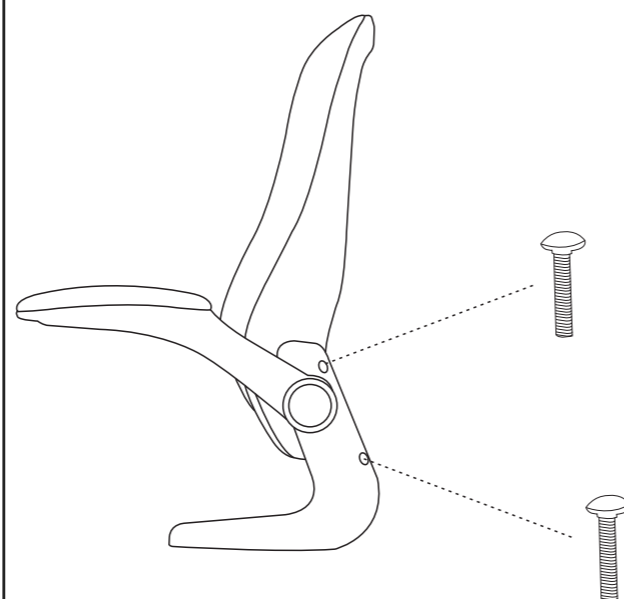

STEP 3

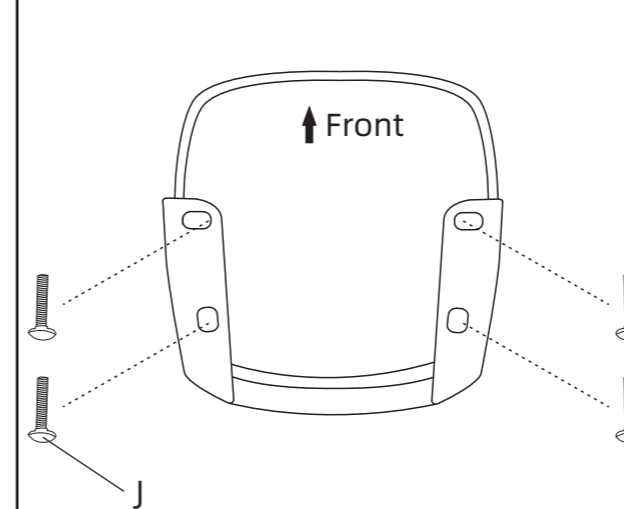

STEP 4

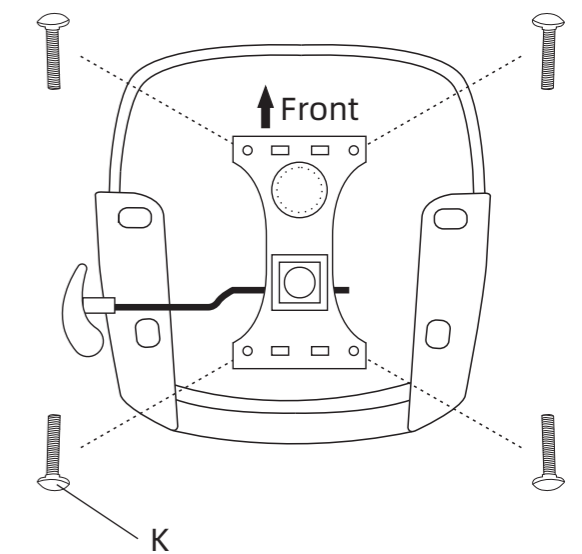

STEP 5

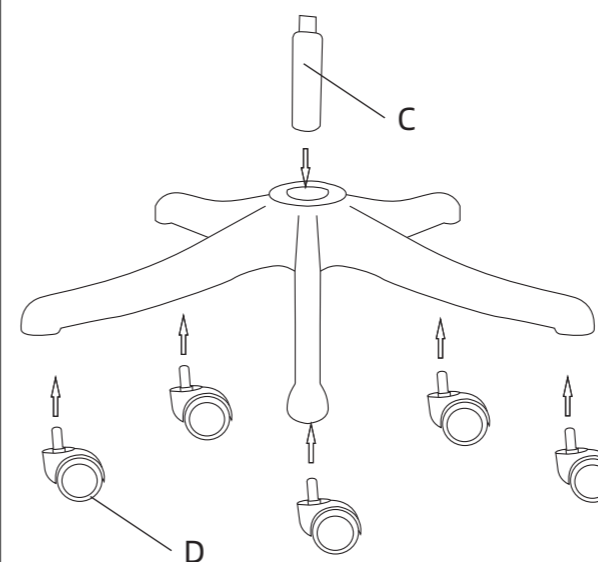

STEP 6

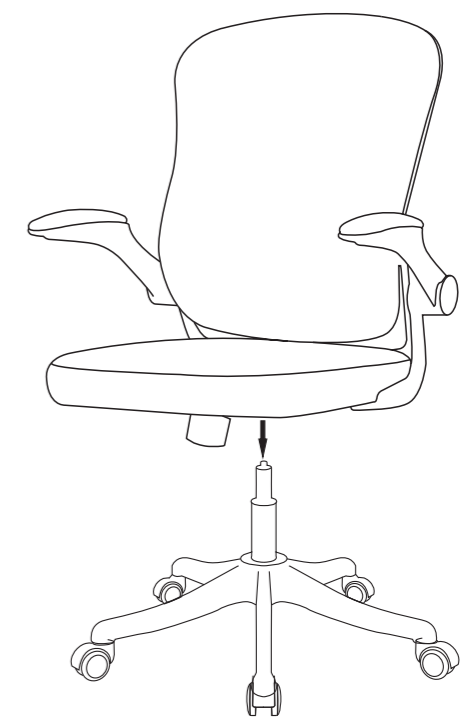

Enjoy your new favorite chair

Our goal is to create a perfect customer experience.

Let us know if you have any feedback.

Your comment motivates us to become a better team.