

## NOTICE

- \* Please make sure that you have all parts indicated and they are in good condition before you begin assembly of this item. Refer to part list and hardware list below for guidance.
- \* This item should be assembled on a soft surface to prevent scratching the finish during assembly.
- \* This item may require periodic tightening.
- \* If you are having difficulty, our friendly Customer Care team is always here to help. Please email [customersupport@safavieh.com](mailto:customersupport@safavieh.com)





## PREPARATION

- \* Before beginning assembly of product, make sure all parts are present. Compare parts with part contents list and hardware contents list.
- \* If any part is missing or damaged, do not attempt to assemble the product.
- \* Estimated assembly time: 15-20 Minutes
- \* Require 1-2 person for assembly.
- \* Tools Required for Assembly (included): Allen Key

## CARE AND MAINTENANCE

Adhesive felt pads should always be applied to areas of furniture which make direct contact with flooring, said application will prevent damage to the furniture and/or surfaces on which the furniture lies. Objects placed on articles of furniture should rest on non-abrasive material as to prevent damage to the wood finish. Objects whose composition consists of plastic and rubber are known to discolor and damage the wood surfaces on which they rest. Wipe up spills immediately and avoid common hazards such as hot dishes, harsh solvents and abrasives. Cleaning should be done with a soft lint-free cotton cloth dampened with water or furniture polish. On highly used surfaces we recommend applying a quality paste wax which should be used on a regular basis to provide additional protection from scratches and spills. How often you apply the wax depends on how much wear the furniture receives.

## CARE AND MAINTENANCE

Piece	Description	Picture	Quantity
A	Marble top		1x
B	Wooden Base		1x
Hw1	JCB Bolt 4x1.25x20 mm		4x
Hw2	Washer		4x
Hw3	Allen key		1x

# SAFAVIEH FURNITURE

Item Id - COF2903A

Dimension - 31.50"X31.50"X18"

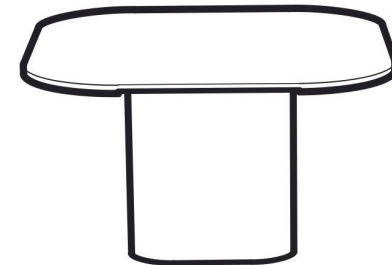

**⚠WARNING⚠**

**Weight Capacity : 15 LBS**

**WARNING : DO NOT STAND ON COFFEE TABLE**

**WARNING : DO NOT OVER TORQUE BOLTS/SCREWS**

**WARNING : HEAVY PRODUCT**

## PREPARATION

- \* Before beginning assembly of product, make sure all parts are present. Compare parts with part contents list and hardware contents list.
- \* If any part is missing or damaged, do not attempt to assemble the product.
- \* Estimated assembly time : 15-20 Minutes.
- \* Tools Required for Assembly (included): Allen Key
- \* If you are having difficulty, our friendly Customer Care team is always here to help. Please email [customersupport@safavieh.com](mailto:customersupport@safavieh.com)

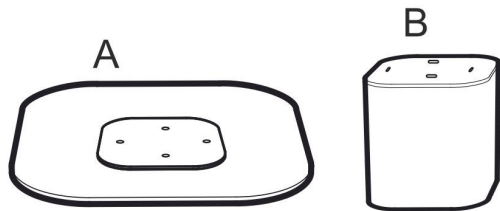

Step 1 : Turn Marble top upside down. Be careful as marble can be heavy and fragile.

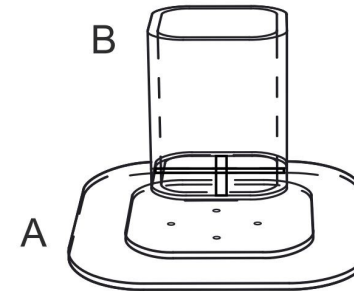

Step 2 : Position wooden Base B over the bottom of Marble top A. Ensure that the attachment points on Base B align with the corresponding points on Marble top A.

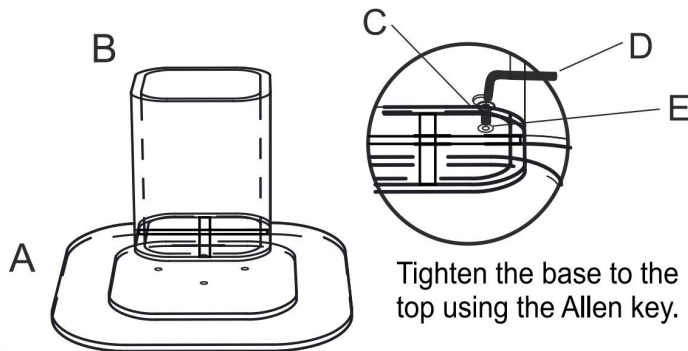

Tighten the base to the top using the Allen key.

Step 3 : Use the JCB Bolt(HW1) to attach Marble Top A and Base B. "You'll" need an Allen key for this step. Insert the Allen key into the screw head and turn clockwise until tight. Be careful not to overtighten as this could damage the marble or the wood.

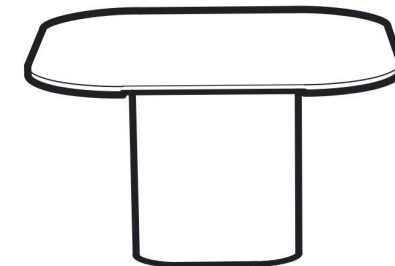

Step 4 : Once Base B is securely attached to Marble top A, carefully turn the assembly right side up. You may need assistance for this step due to the weight of the Marble.