

# MANUAL INSTRUCTION

Metal Garden Shed  
IS302BK02

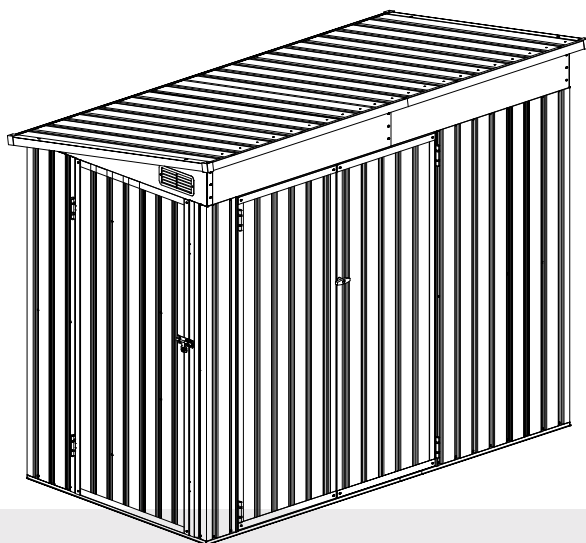

## **Outdoor Furniture**

---

We are a professional furniture provider with top-notch factories and outstanding designs, Our mission is to provide consumers with new lifestyles. By collecting consumer feedback, we constantly improve our products and create more choices for consumers. If you want to create your space, We are an ideal choice.

---

Always.

---



## WARNING

All the Products have passed strict quality inspections before delivery . Read this manual carefully to ensure proper usage

---

Ensure that all parts and hardware are available before beginning assembly

# BEFORE YOU START

## Owner's Manual

Prior to installation, it is important that you contact your local government authority to determine if building approval is required. Study and understand this owner's manual. Important information and helpful tips will make your construction easier and more enjoyable.

## Assembly instructions

Instructions are supplied in this manual and contain all appropriate information for your building model. Review all instructions before you begin. During assembly, follow the step sequence carefully for correct results.

## Parts

Check to be sure that you have all the necessary parts for the building.

Separate contents of the carton by the part number while reviewing parts list.

Familiarize yourself with the hardware and fasteners for easier use during construction. These are packaged within the carton. Note that extra fasteners have been supplied for your convenience.

# TOOLS MAY REQUIRED

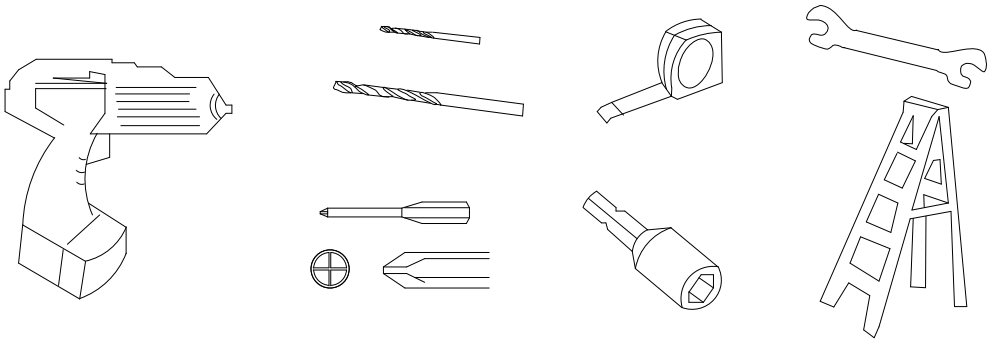

Use heavy duty gloves when handling steel sheets and flashing

# PLAN AHEAD

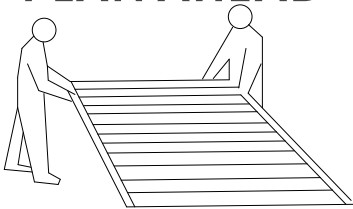

## Watch the weather :

Please be sure the day you select for installation is dry and calm.

## DO NOT attempt to assemble your shed in windy weather

because of risk of damage to panels, or personal injury. Be care of wet or muddy ground.

## Teamwork :

Whenever possible, two or more people should work together to assemble the building. One person can position parts or panels while the other is able to handle the fasteners and the tools.

# PLAN AHEAD

## Site Selection

- Avoid overhanging trees as much as possible as leaves will make regular cleaning necessary and broken branches are a potential hazard.
- Small trees, bushes or fences nearby can be helpful, acting as a wind break.

## Site Preparation

The site must be prepared so that the base of the shed is level all round and checking with a spirit level is required.

The base can be constructed by treated timber or concrete, in order to stop the moisture getting into the shed. **The shed is not designed to be built onto lawn directly**. Also the ground will get muddy during rainy days.

If a concrete pad is made, it is important that this slopes towards the edges to prevent water ingress.

Time must be allowed for any concrete or cement to dry before building the shed on top.

Bases can also be constructed from bricks, blocks, or mounted on a concrete pad.

The bricks blocks should be cemented onto and level concrete footings and greenhouse frame drilled and screwed to the base.

# IMPORTANT NOTES

- Find someone to help you: it is much easier with someone to hold parts, pass tools etc. Also some steps require two people to lift structures together. This is not very heavy work so would suit most able-bodied people.

Allow plenty of time: rushing often causes errors and the re-doing of incorrect assemblies. If you have never

- built a shed before, it can take most of a day to carefully complete the construction.
- Have the right tools to hand.
- Safety clothing as recommended in the 'tools' section.
- Ideally lay out the parts and check that all are present before commencing construction. Lay on cloths or plastic sheets if there is any risk of scratching the parts.
- Tighten all nuts carefully, being sure not to miss any. Check the frame is square and using a spirit level to check that it is upright.

# TOOLS REQUIRED



Electric  
Screwdriver



+Manual  
Screwdriver



Ladder







2-4 Persons Assembly



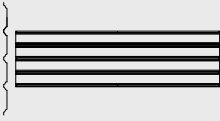

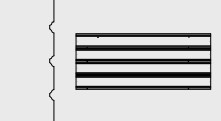
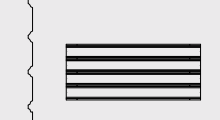
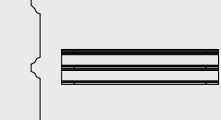
Up to 120 Minutes For Assembly

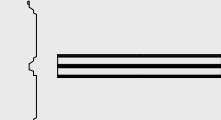
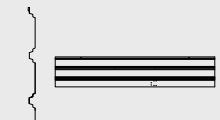
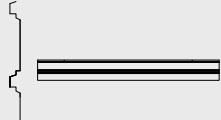
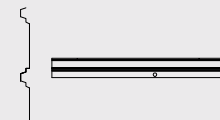
## PARTS LIST A

<b>W5</b>  7 PCS	<b>W5-X</b>  1 PCS	<b>W5-K</b>  2 PCS	<b>Y48-8</b>  2 PCS
<b>Y48-8M</b>  3 PCS	<b>Y48-8MM</b>  1 PC	<b>W3-C</b>  4 PCS	<b>W3</b>  4 PCS
<b>W3-HX</b>  1 PC	<b>W2-HL</b>  1 PC	<b>W2-HR</b>  1 PC	

## PARTS LIST B

<b>K48-1L</b>  2 PCS	<b>K48-1R</b>  2 PCS	<b>C46-2</b>  2 PCS	<b>C46-3</b>  2 PCS
--	---	--	---

# PARTS LIST B

Y48-4L



1 PC

Y48-4R



1 PC

Y48-5L



1 PC

Y48-5R

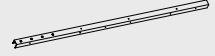

1 PC

C46-6L

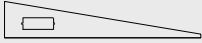

1 PC

C46-6R

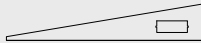

1 PC

C48-7L



1 PC

C48-7R



1 PC

Y48-9



2 PCS

Y48-10L



2 PCS

Y48-10R



2 PCS

ULA



1 PC

URA



1 PC

DX1

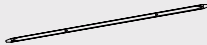

2 PCS

DLA1



1 PC

DRA1



1 PC

DD

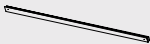

2 PCS

UA



2 PCS

DA













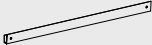

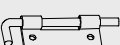

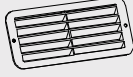
2 PCS

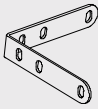
DLA

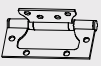

1 PC

# PARTS LIST B

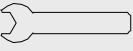
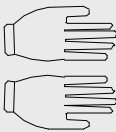
<b>DRA</b>  1 PC	<b>DDA</b>  4 PCS	<b>DBA</b>  4 PCS	<b>DC</b>  2 PCS
<b>GL</b>  1 PC	<b>GC</b>  4 PCS	<b>GF</b>  2 PCS	<b>T-F</b>  4 PCS
<b>C2</b>  4 PCS	<b>C14</b>  1 PC	<b>F1</b>  259 PCS	<b>F2</b>  52 PCS
<b>F3</b>  48 PCS	<b>V2</b>  78 PCS	<b>DH</b>  6 PCS	<b>DCS</b>  1 PC
<b>M20</b>  1 PC	<b>ST</b>  2 PCS		

## PARTS

Before installation, please place the parts in the position as shown in the figure below.

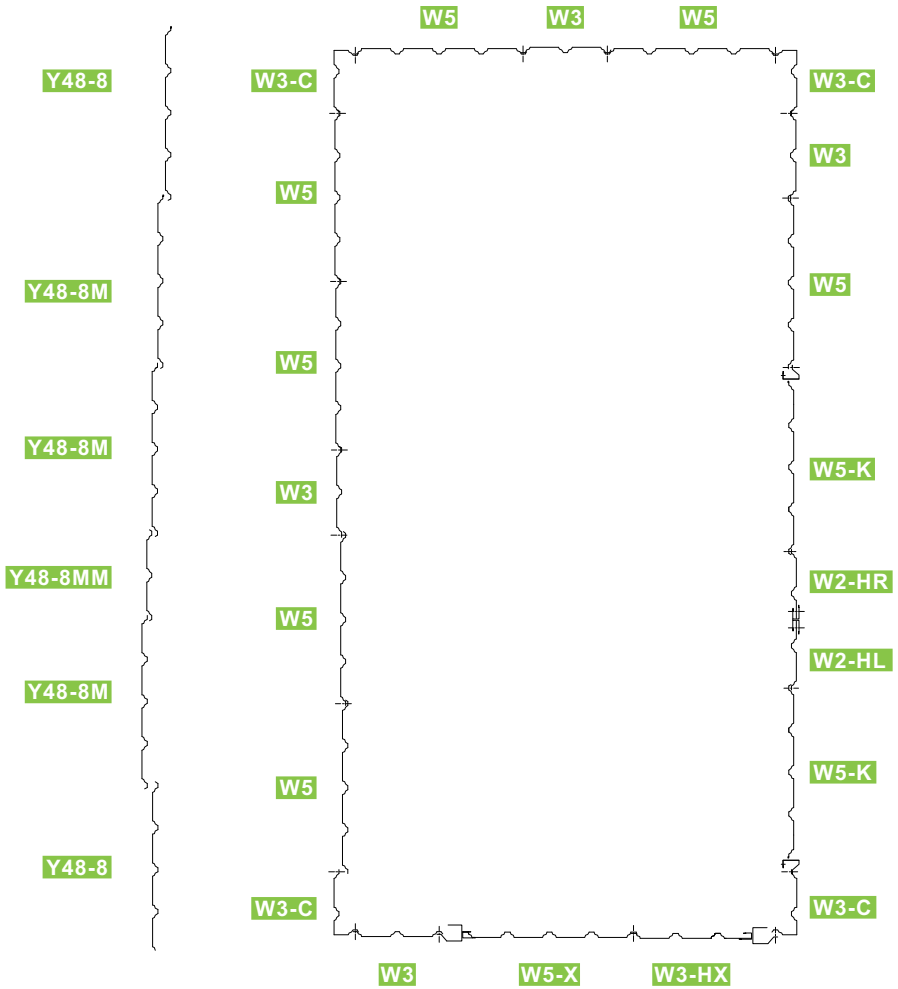





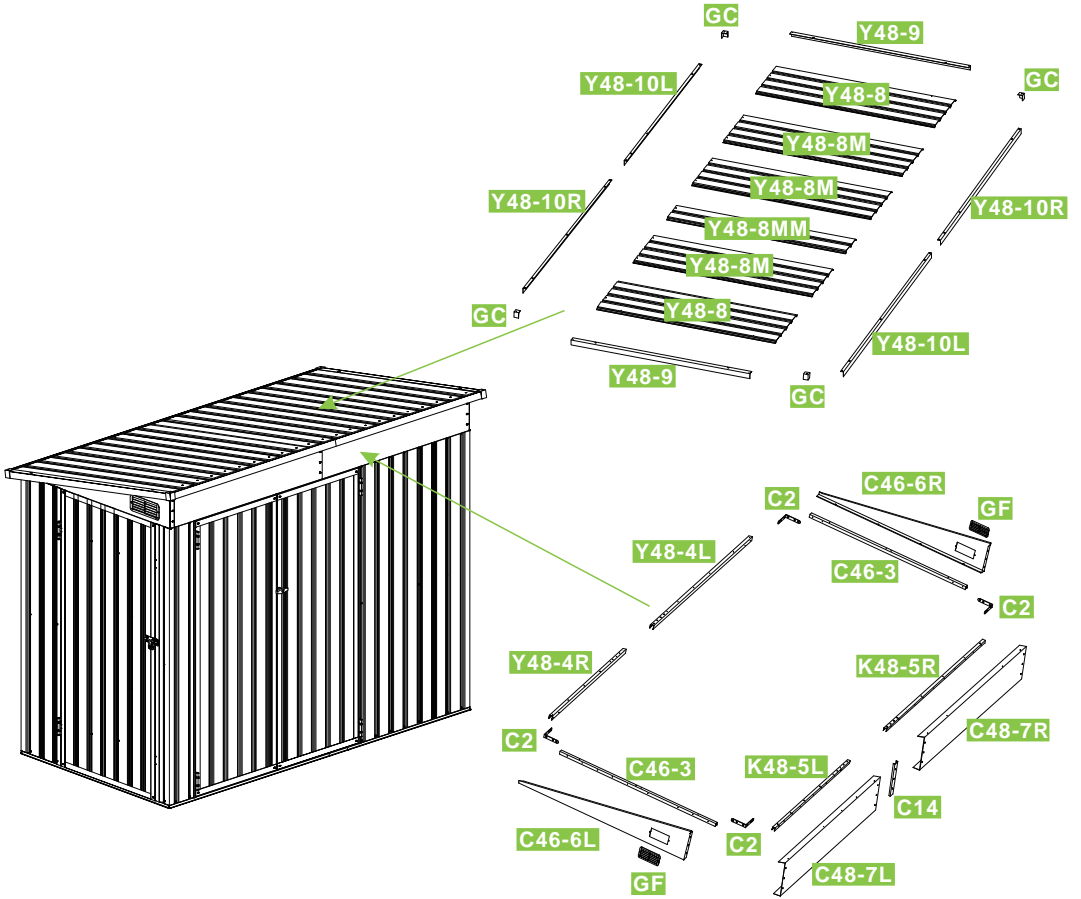

# PARTS

Before installation, please place the parts in the position as shown in the figure below.



# PRODUCT ASSEMBLY

1

PART	NO.	QTY.
	K48-1L	2
	K48-1R	2
	C46-2	2
	T-F	4
	F1	30

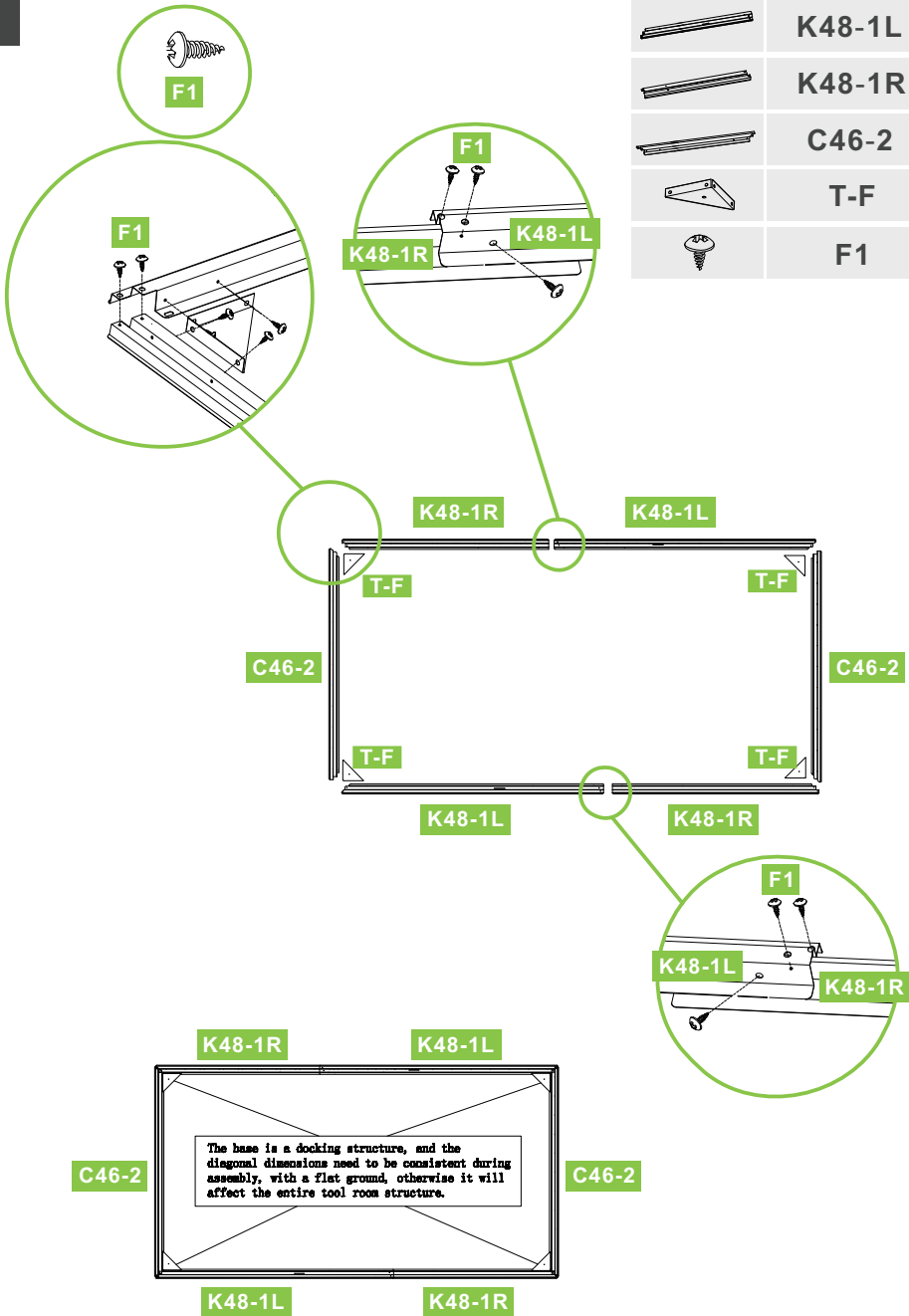

# PRODUCT ASSEMBLY

2

PART	NO.	QTY.
	W3-C	4
	F1	4

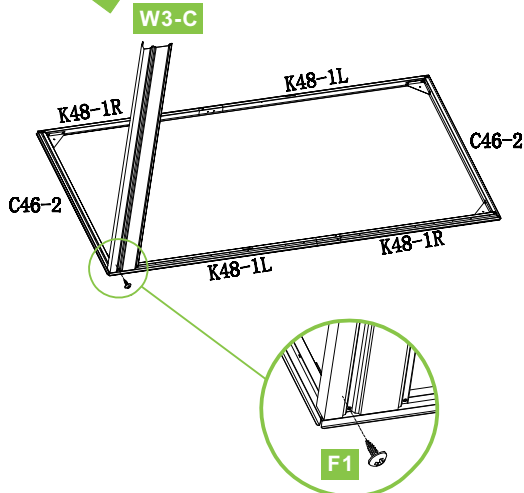
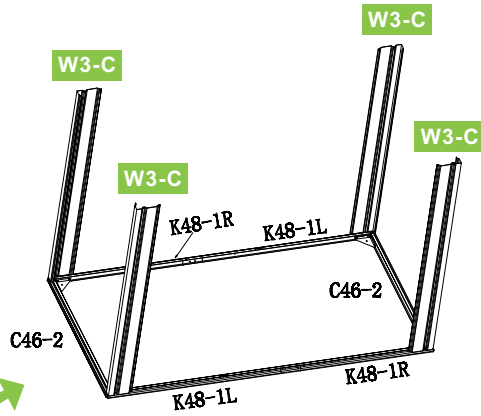
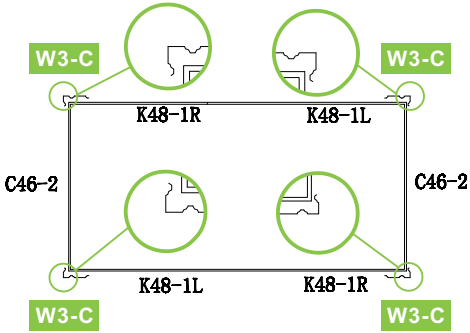

# PRODUCT ASSEMBLY

3

PART	NO.	QTY.
	Y48-4L	1
	Y48-4R	1
	K48-5L	1
	K48-5R	1
	C46-3	2
	C2	4
	F1	24

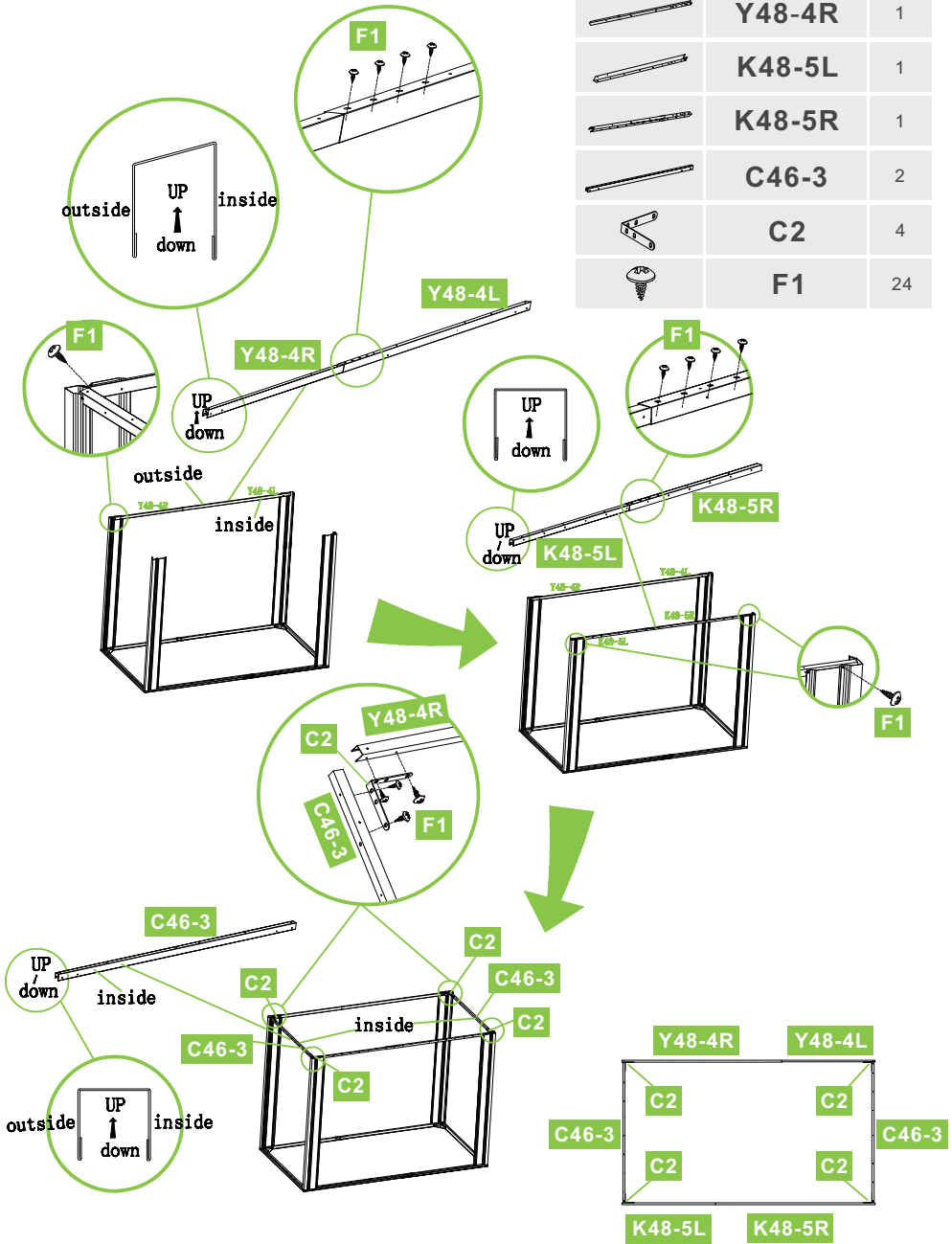

# PRODUCT ASSEMBLY

4

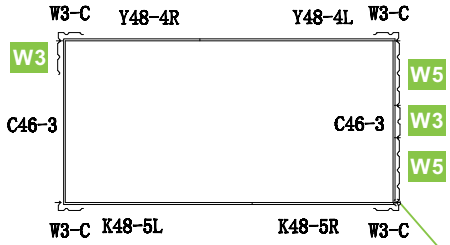



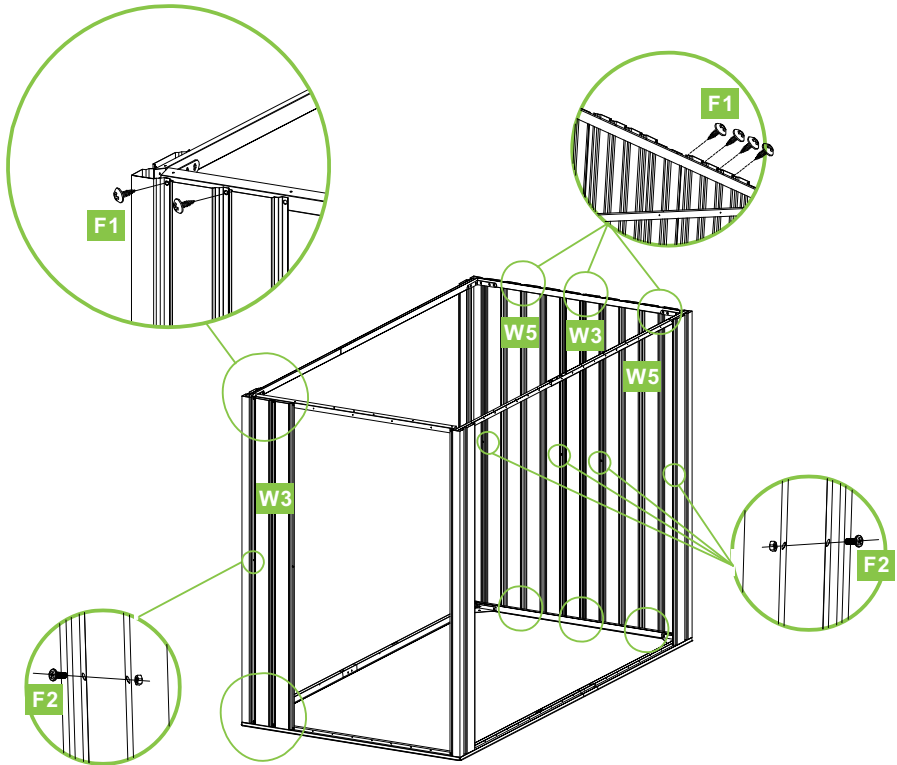

PART	NO.	QTY.
	W5	2
	W3	2
	F1	26
	F2	5



# PRODUCT ASSEMBLY

## 5

PART	NO.	QTY.
	<b>W5</b>	4
	<b>W3</b>	1
	<b>F1</b>	38
	<b>F2</b>	6

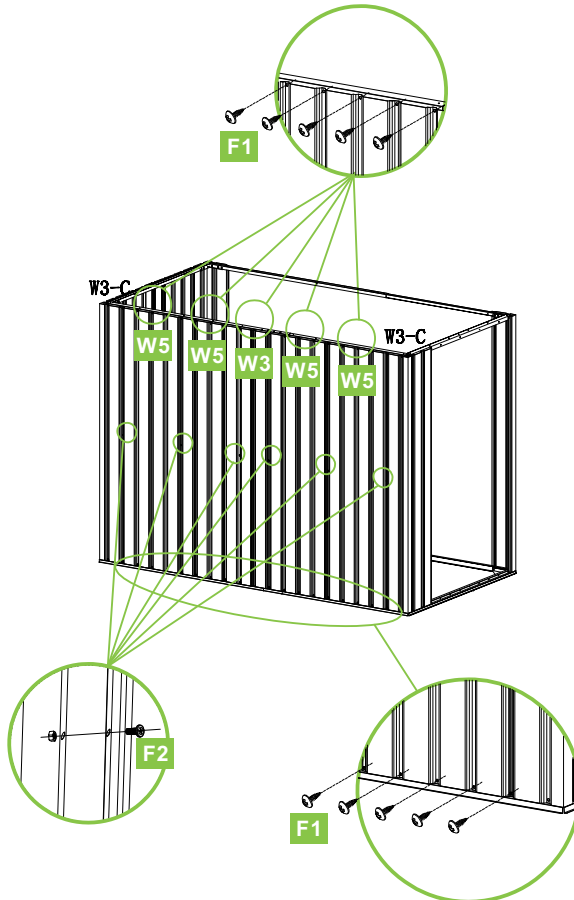
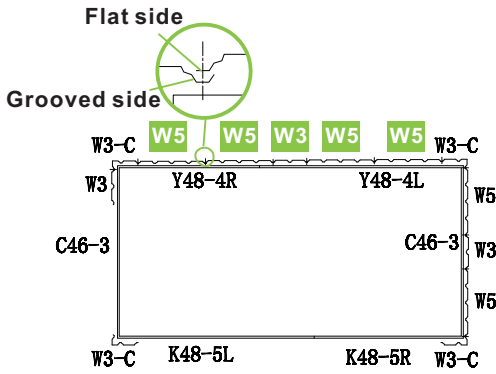

# PRODUCT ASSEMBLY

6

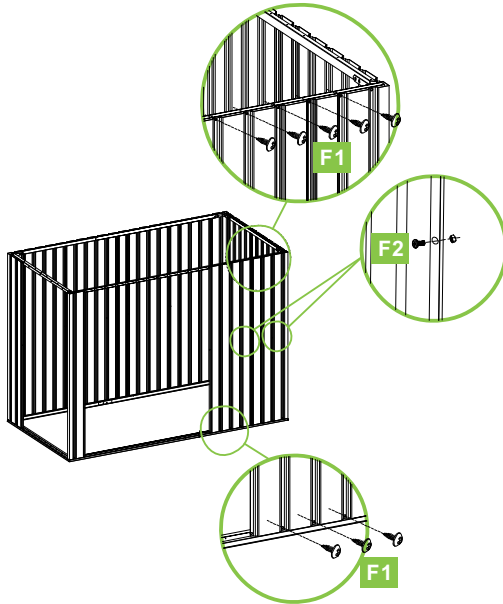

PART	NO.	QTY.
	W5	1
	W3	1
	F1	12
	F2	2

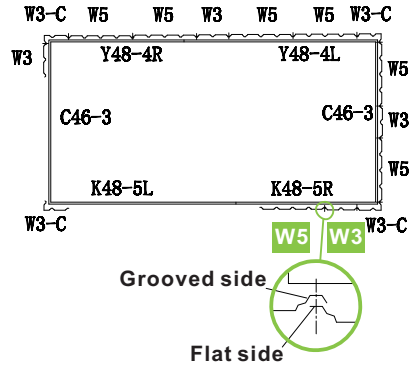

7

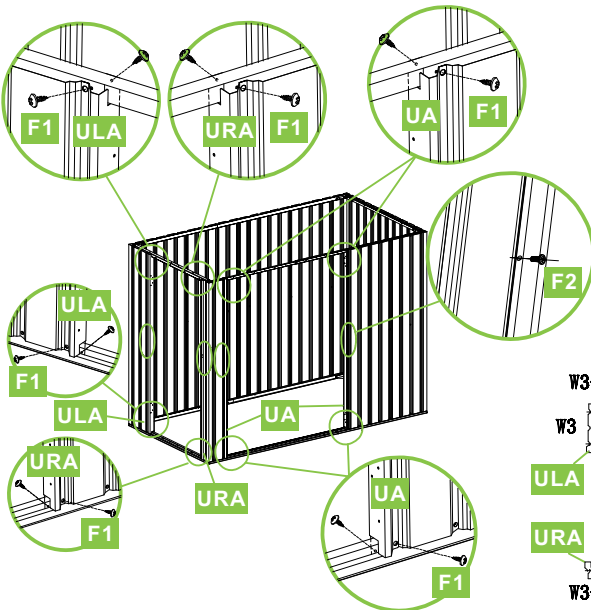

PART	NO.	QTY.
	UA	2
	ULA	1
	URA	1
	F1	16
	F2	4

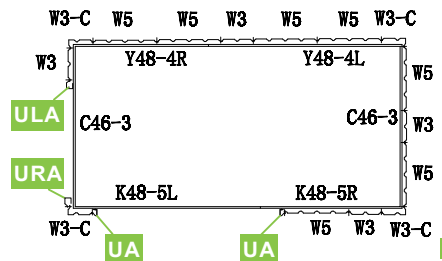

# PRODUCT ASSEMBLY

8

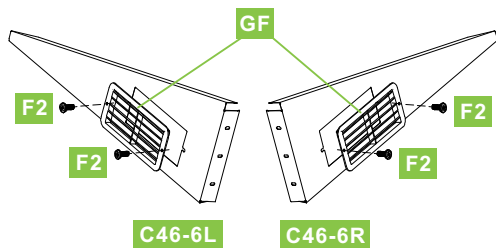

PART	NO.	QTY.
	C46-6L	1
	C46-6R	1
	F1	6
	F2	4
	V2	6
	GF	2

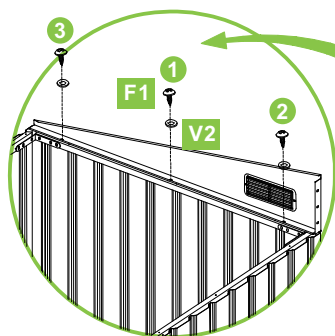



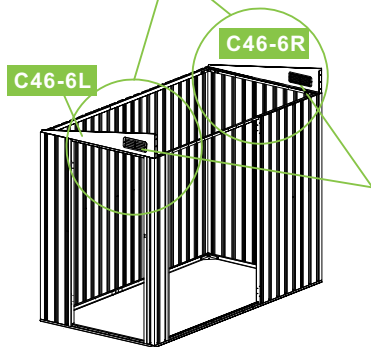



Assemble the screws of the ventilation plate in the order shown in the figure, and install the middle hole first to avoid misalignment.



Pay attention to the installation direction of the ventilation panel as shown in the diagram.

# PRODUCT ASSEMBLY

9

PART	NO.	QTY.
	C48-7L	1
	C48-7R	1
	C14	1
	F1	10
	F2	9
	V2	10

C14 is the roof load-bearing support member and is connected to the joints of C48-7L and C48-7R.

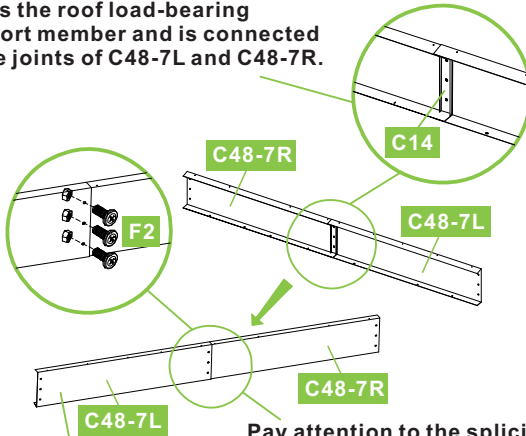



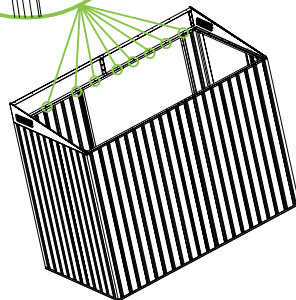
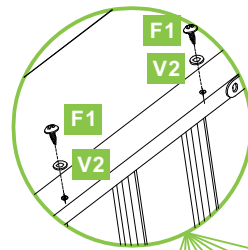
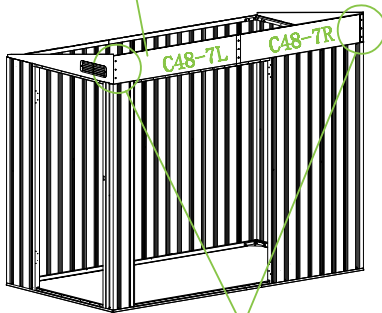

Pay attention to the splicing method of C48-7L and C48-7R. C48-7R is small in width and size. It should be inserted into C48-7L and connected with 3 F2 screws.



# PRODUCT ASSEMBLY

## 10

PART	NO.	QTY.
	Y48-8	2
	Y48-8M	3
	Y48-8MM	1
	V2	42
	F1	42

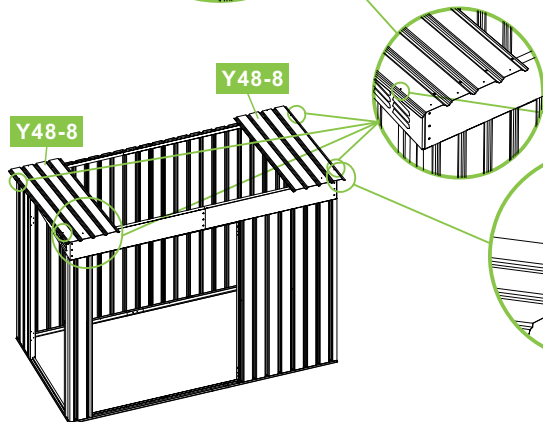
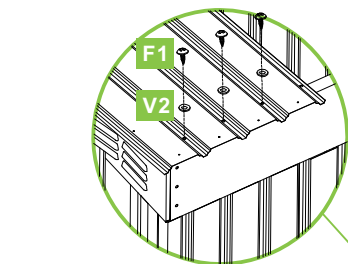

The flat side has a small hole for mounting on the outside. The small hole is the Y48-9 accessory assembly hole.

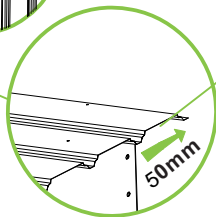

Install as shown in the picture: the edge extends outward by about 50mm.

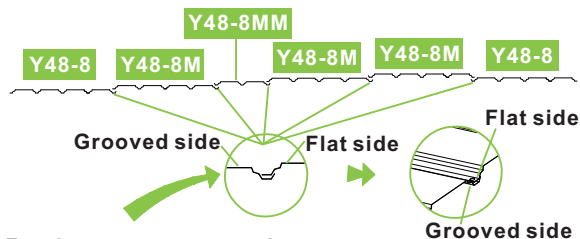



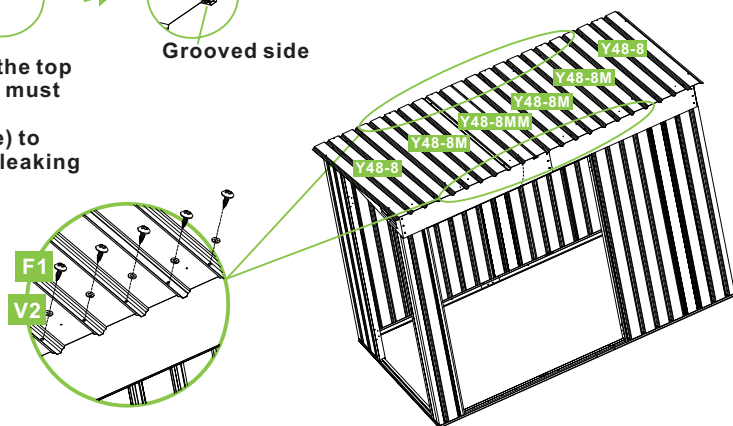



For the way to connect the top cover, the grooved side must be below the flat side (as shown in the picture) to prevent rainwater from leaking through the overlap.



# PRODUCT ASSEMBLY

## 11

PART	NO.	QTY.
	Y48-9	2
	Y48-10L	2
	Y48-10R	2
	V2	20
	F1	20
	GC	4

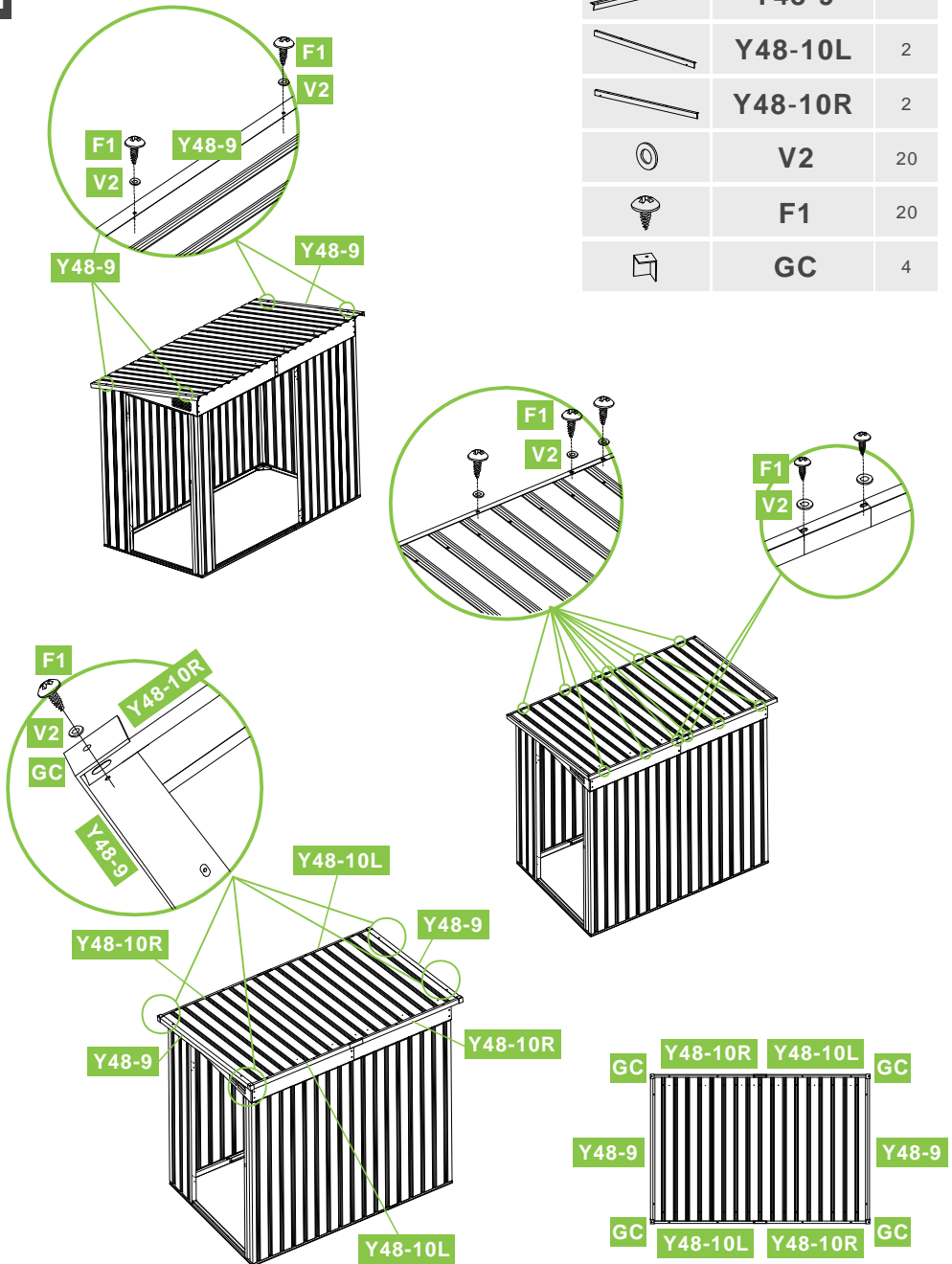

# PRODUCT ASSEMBLY

## 12

PART	NO.	QTY.
	W5-K	1
	W2-HL	1
	F2	2

**Left door panel splicing**

## 13

PART	NO.	QTY.
	DA	1
	DLA	1
	DDA	2
	DBA	2
	F1	9
	F2	2

# PRODUCT ASSEMBLY

## 14



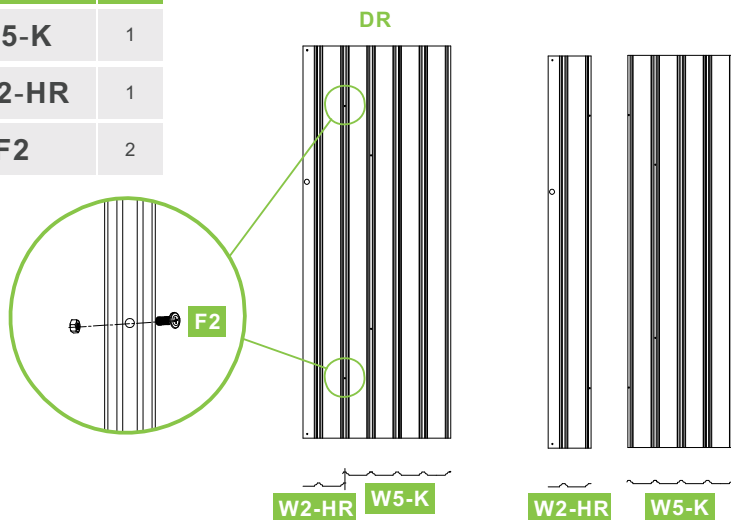



PART	NO.	QTY.
	W5-K	1
	W2-HR	1
	F2	2

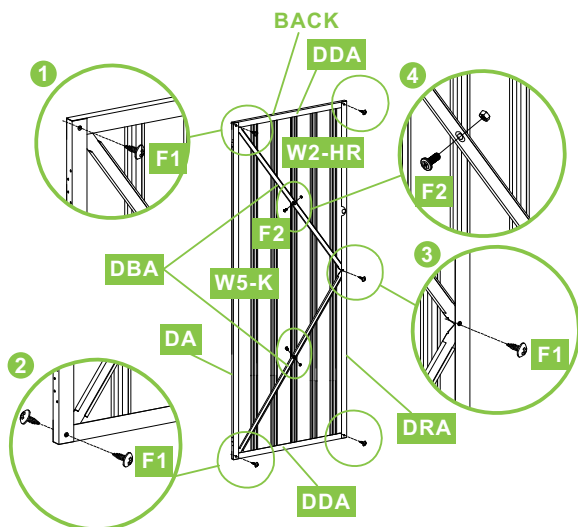

Right door panel splicing





## 15



PART	NO.	QTY.
	DA	1
	DRA	1
	DDA	2
	DBA	2
	F1	9
	F2	2

# PRODUCT ASSEMBLY

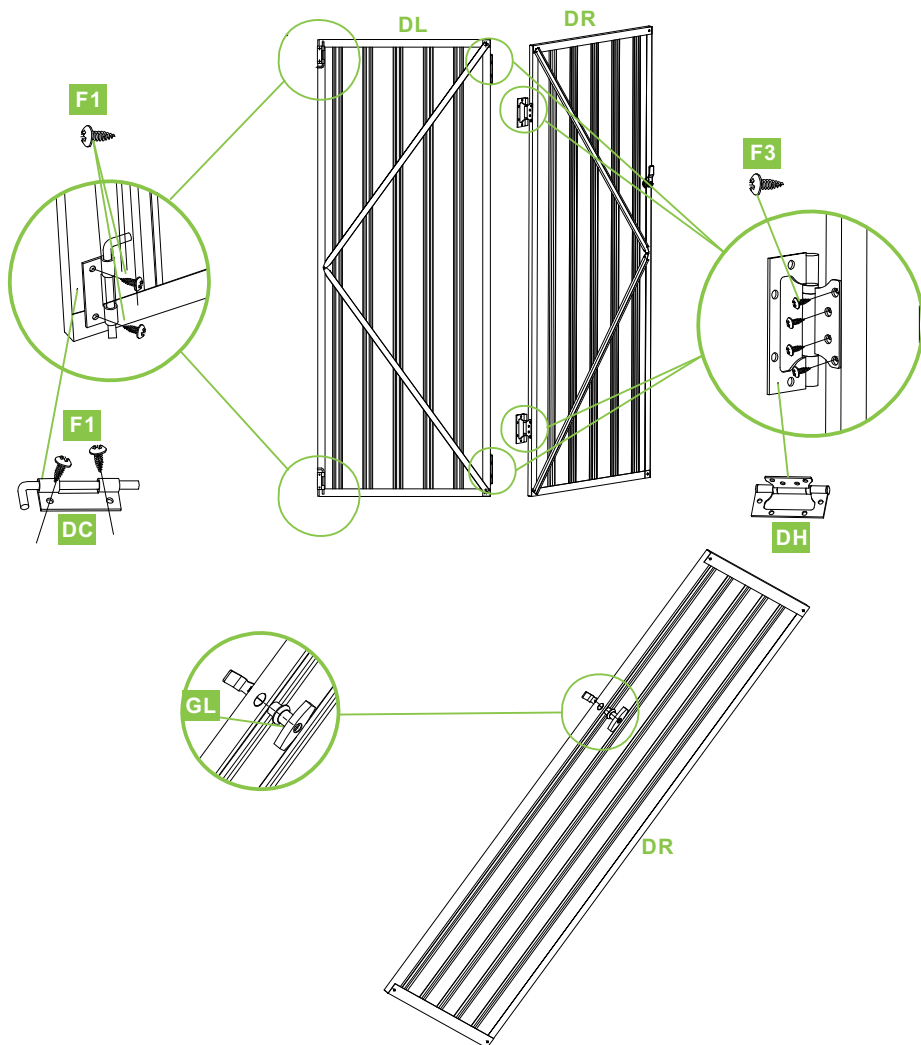

## 16

PART	NO.	QTY.
	DH	4
	DC	2
	F3	16
	GL	1
	F1	4



# PRODUCT ASSEMBLY

17

PART	NO.	QTY.
	DL	1
	DR	1
	F3	16

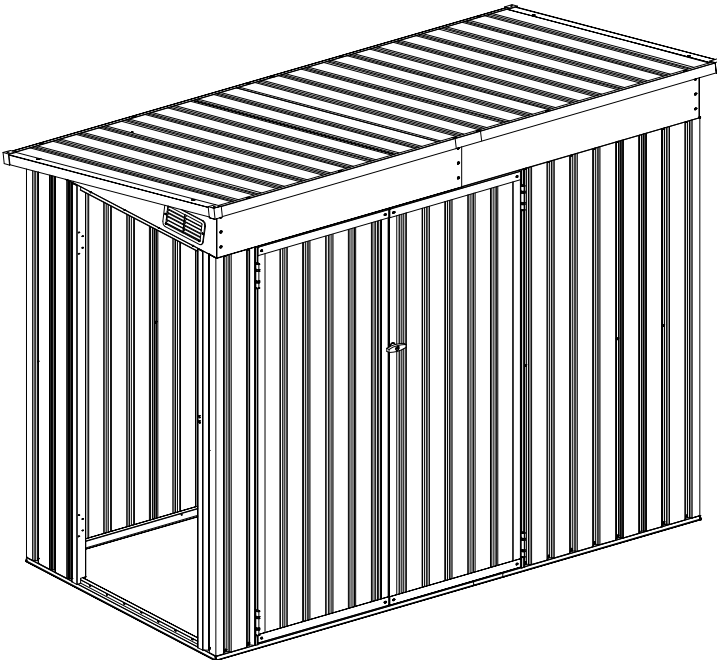
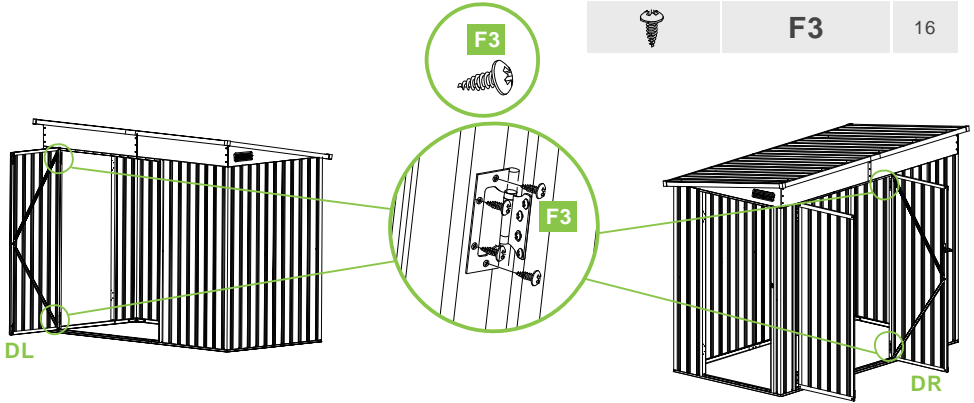

# PRODUCT ASSEMBLY

## 18

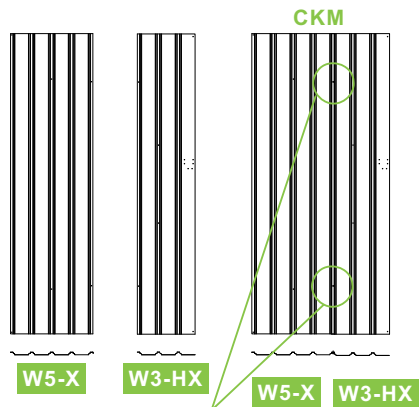



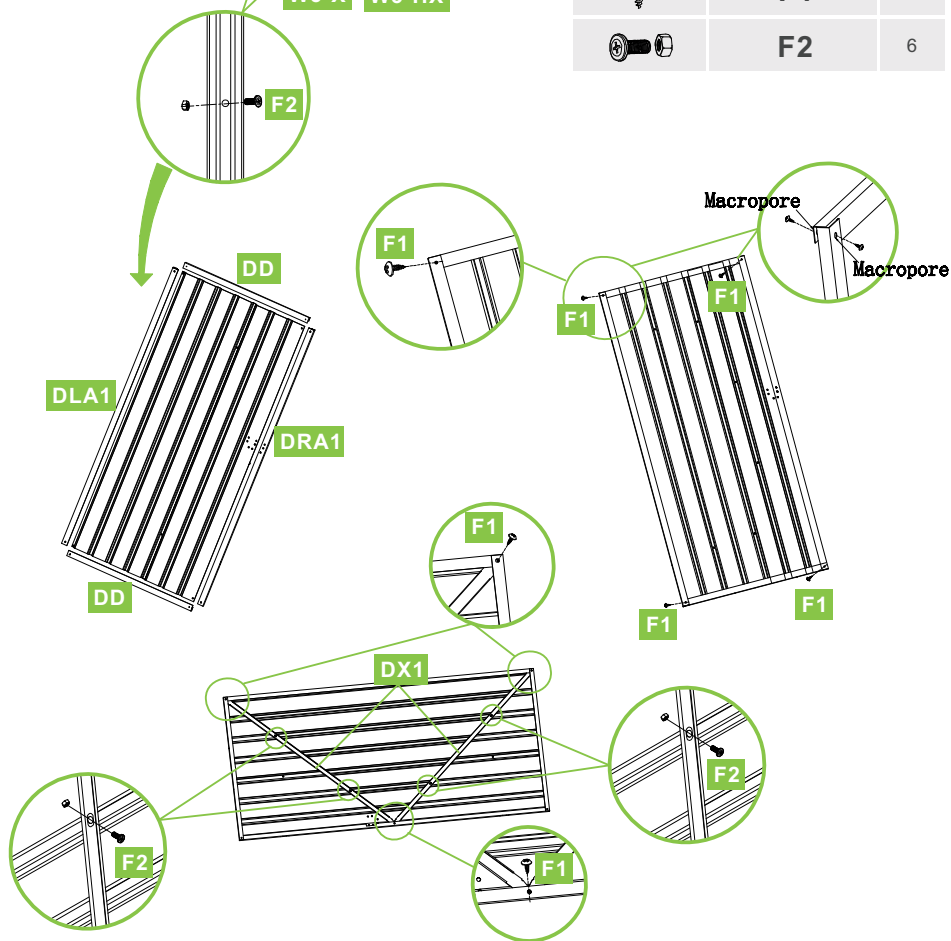

PART	NO.	QTY.
	W5-X	1
	W3-HX	1
	DD	2
	DLA1	1
	DRA1	1
	DX1	2
	F1	9
	F2	6



# PRODUCT ASSEMBLY

## 19



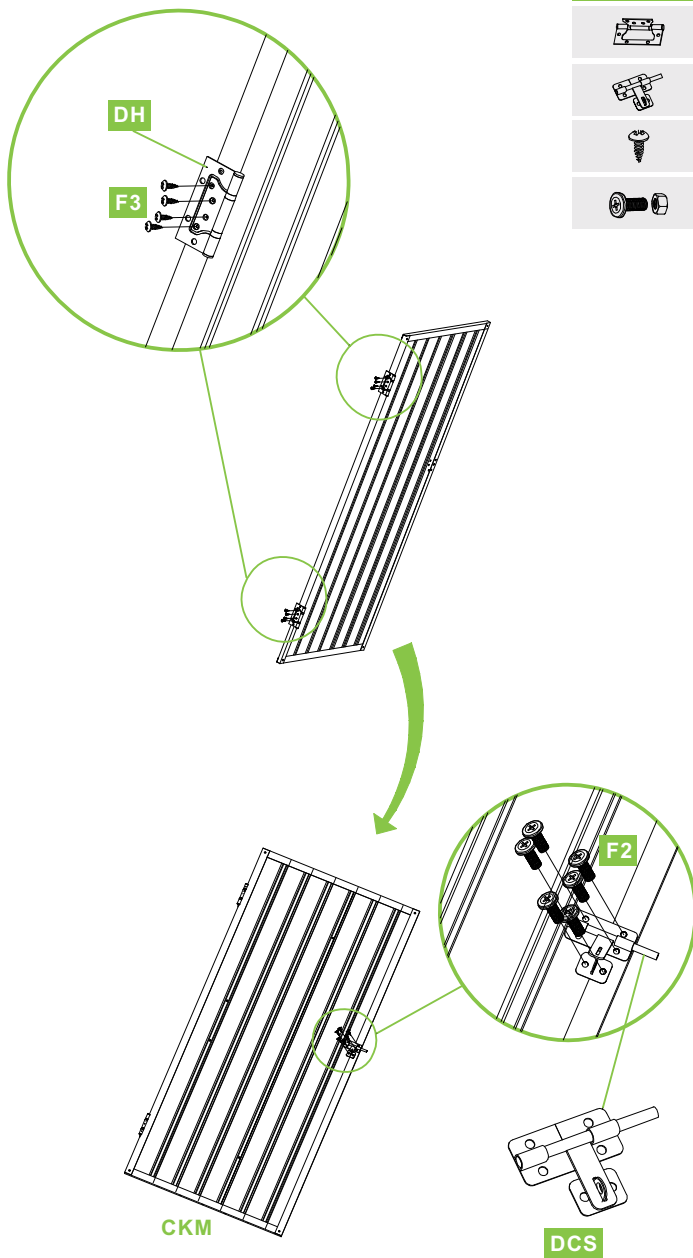

PART	NO.	QTY.
	DH	2
	DCS	1
	F3	8
	F2	6

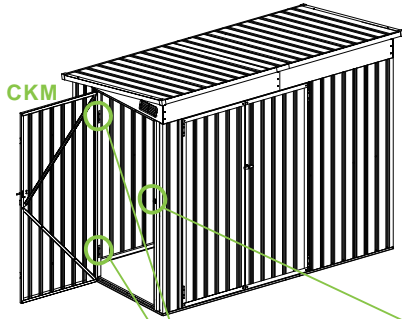

# PRODUCT ASSEMBLY

20



PART	NO.	QTY.
	<b>CKM</b>	1
	<b>DCS</b>	1
	<b>F3</b>	8
	<b>F2</b>	2

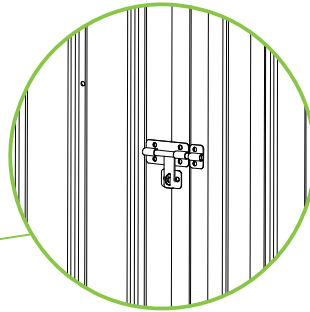
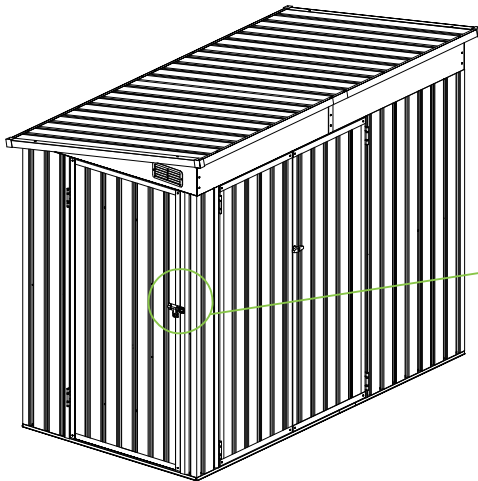
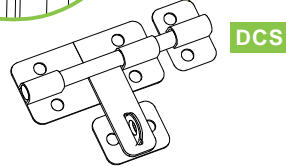
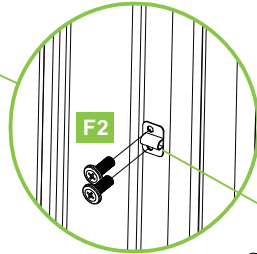
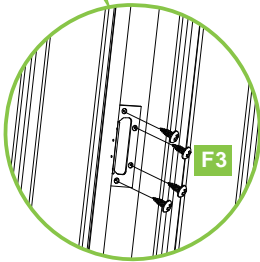

# HELP CENTER

Question about your product? We're here to help. Visit us at:

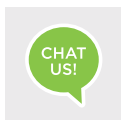

Chat Support

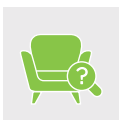

Product Inquiry

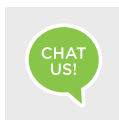

Orders FAQ



Product Assembly



Returns & Refunds

## We Stand Behind the Quality of Their Furniture

If you have any issues with your item please let us know! We will always do our best to come up with a solution that you will be happy with.

Please get in touch with our customer service team before returning the product.

And pls do not throw the original box(es) if you have not finished assembling or confirmed no quality issues.

Length of return period:

Items can be returned within 30 days of purchase.

In the meanwhile, everything you purchased from us comes with a one-year warranty.

Who is responsible for the return shipping fee:

We will cover the return shipping fees if:

1. Your item has a manufacturing defect in its materials or workmanship. For example, torn wicker or misaligned screw holes. We will send you a prepaid shipping label after photos are sent.
2. Your item has been damaged in transit. For example, glass is broken or wicker is damaged. We will send you a prepaid shipping label after photos are sent.
3. You receive the wrong box(es) due to a warehouse error. We will send you a prepaid shipping label after photos are sent of the wrong SKU numbers on the outer box(es).
4. One or more boxes are lost in transit. We will send you a prepaid shipping label if you no longer want the item.

\*However, we still hope to work with you for a better solution instead of a return. Please don't hesitate to contact our customer service team.

Customer will cover the return shipping fees if:

1. You don't like the product(s) after receiving the box(es).
2. You no longer need the product(s) but you have received the box(es).
3. You buy the product(s) by mistake but you have received the box(es).
4. Order/Shipment cancellation failed and you have received the box(es).

---

## Return Request

In order to get a full refund as described in this return policy, all items must be: (1) In a brand new/unused condition, please provide photos before and after packaging. (2) When returning, all accessories and parts are firmly packed in all original packaging.

If your return does not meet the requirements, you may not get a full refund.

When will I be refunded?

The refund is released once the goods have been returned to our warehouse.

What if the product is damaged/defective outside of the valid return period?

We want you to be a happy customer. Please reach out to us by email and we will come up with a solution to make sure you are satisfied.