

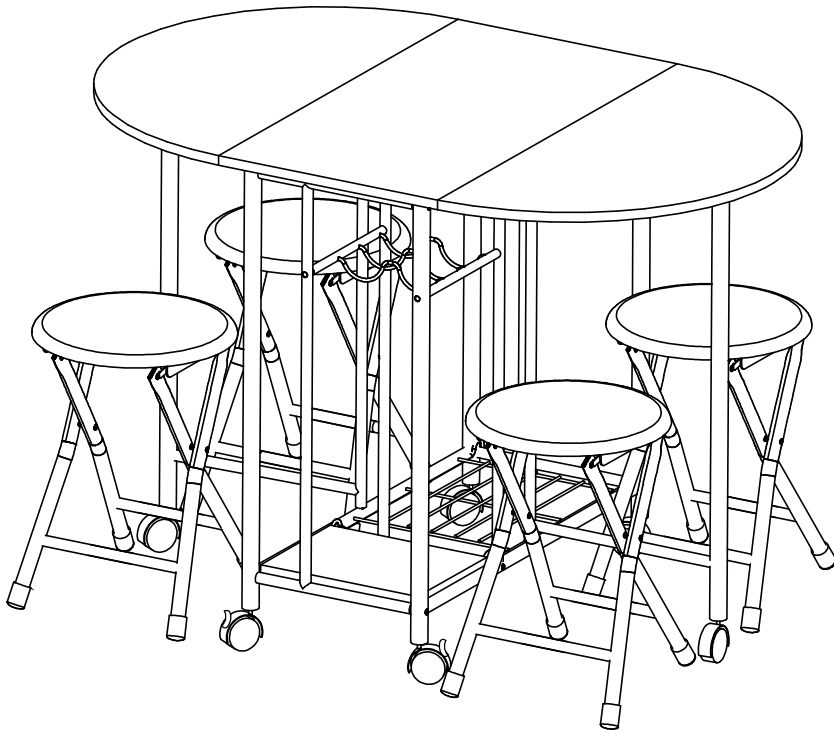

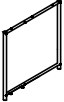

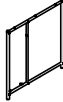















ASSEMBLY INSTRUCTIONS





| | | | | | | |
|--|--|---|--|---|---|---|
| 1  1 PCS | 2  1 PCS | 3  2 PCS | 4  1 PCS | 5  1 PCS | 6  2 PCS | 7  1 PCS |
| 8  1 PCS | 9  1 PCS | 10  2 PCS | 11  1 PCS | 12  1 PCS | | |
| A  M6×35mm 9 PCS | B  M6×35mm 4 PCS | C  M6×28mm 13 PCS | D  28 PCS | E  4 PCS | F  4 PCS | G  4 PCS |
| H  2 PCS | I  M6×12mm 2 PCS | J  1 PCS | | | | |

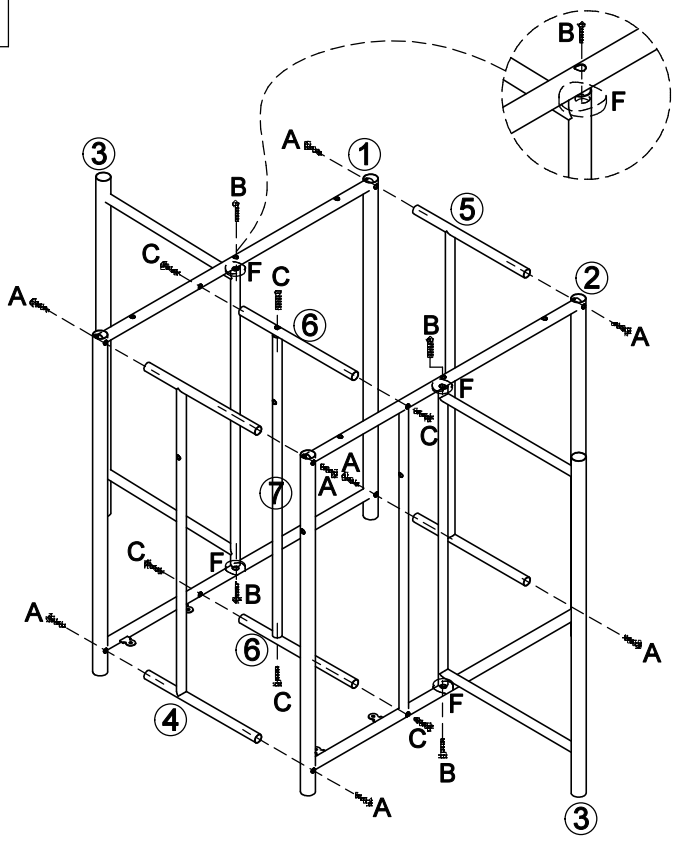

1

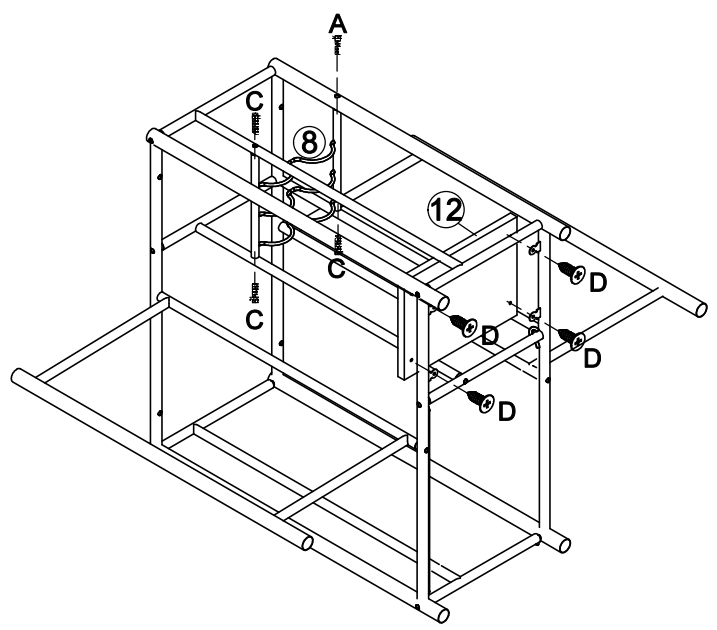

2







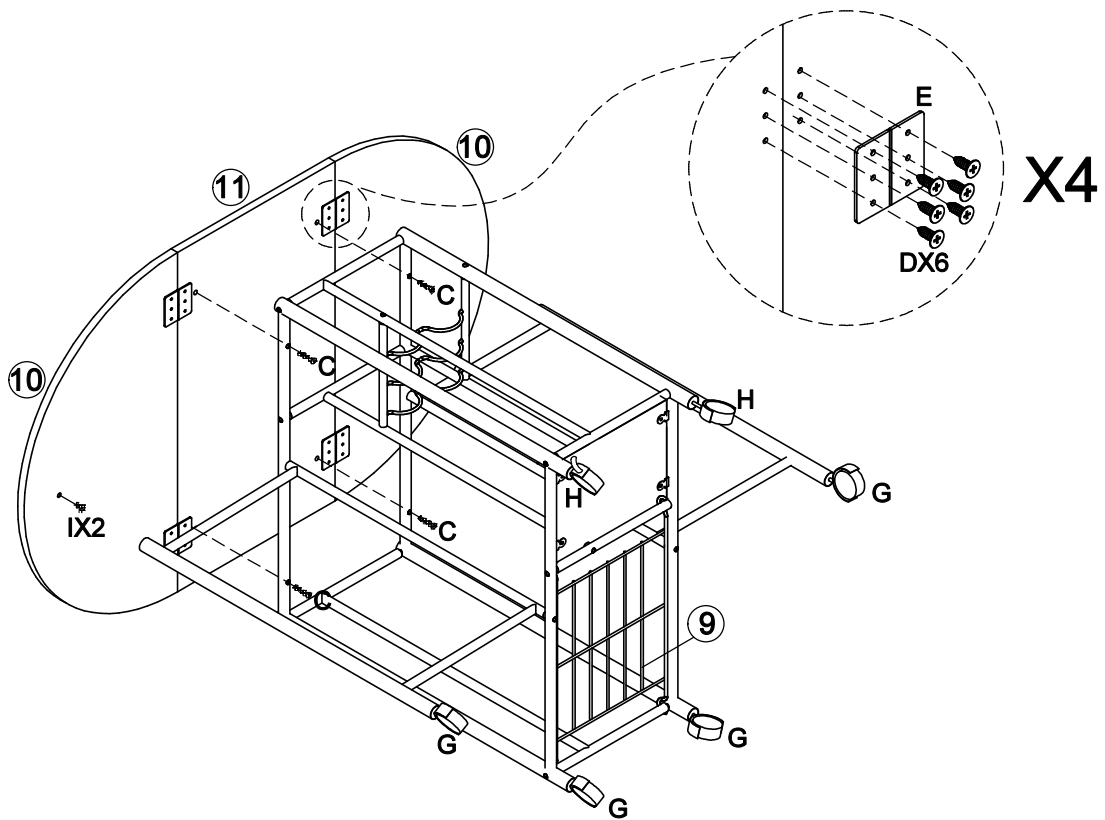

| | | | |
|--|---|---|---|
| <p>A</p>  <p>M6×35mm 8 PCS</p> | <p>B</p>  <p>M6×35mm 4 PCS</p> | <p>C</p>  <p>M6×28mm 6 PCS</p> | <p>F</p>  <p>4 PCS</p> |
|--|---|---|---|

| | | |
|---|---|---|
| <p>A</p>  <p>M6×35mm 1 PCS</p> | <p>C</p>  <p>M6×28mm 3 PCS</p> | <p>D</p>  <p>4 PCS</p> |
|---|---|---|

3



| | | | | | |
|--|---|--|--|--|--|
| <p>C</p>  <p>M6×28mm 4 PCS</p> | <p>D</p>  <p>24 PCS</p> | <p>E</p>  <p>4 PCS</p> | <p>G</p>  <p>4 PCS</p> | <p>H</p>  <p>2 PCS</p> | <p>I</p>  <p>M6×12mm 2 PCS</p> |
|--|---|--|--|--|--|