

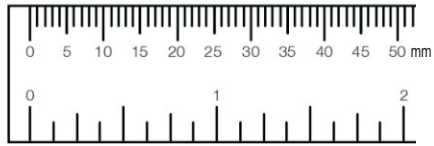







 <p>1 TABLE TOP X1</p>		 <p>2 LEGS X4</p>			
 <p>A Connecting X1</p>	 <p>B Bolt 8X16 X8</p>	 <p>C Washer X8</p>	 <p>D Washer 8XØ16X2 X8</p>	 <p>E Allen Key X1</p>	 <p>F Bolt 8X20 X4</p>
 <p>G Washer 8XØ18X1 X4</p>	 <p>H Nut X4</p>	 <p>I Allen Key X1</p>	 <p>J Foot Pad X8</p>		



Safety and Care Advice

Important – Please read these instructions fully before starting assembly

Check you have all the components and tools listed.

Remove all fittings from the plastic bags and separate them into their groups.

Keep children and animals away from the work area, small parts could choke if swallowed.

Make sure you have enough space to layout the parts before starting.

Assemble the item as close to its final position (in the same room) as possible.

Do not overtighten the nuts to avoid causing damage to the threads.



We do not recommend the use of power drill/drivers **for inserting screws**, as this could damage the unit. Only use hand screwdrivers and Allen keys.

Care and maintenance

Only clean using a damp cloth and mild detergent, do not use bleach or abrasive cleaners.

From time to time check that there are no loose screws on this unit.

This product should not be discarded with household waste. Take to your local authority waste disposal centre.

1

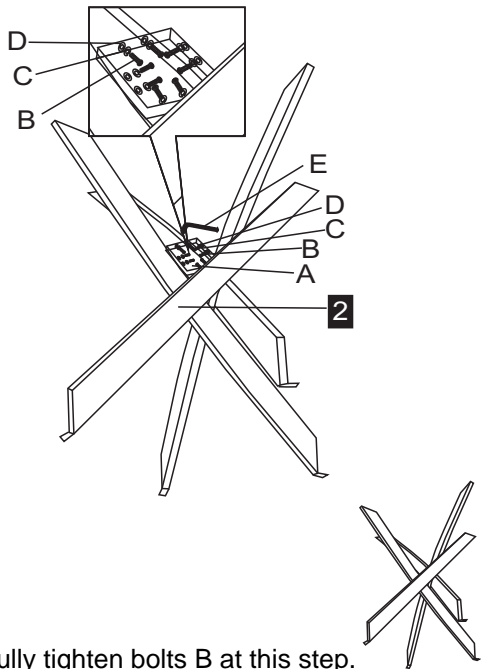

Please do not fully tighten bolts B at this step.

2

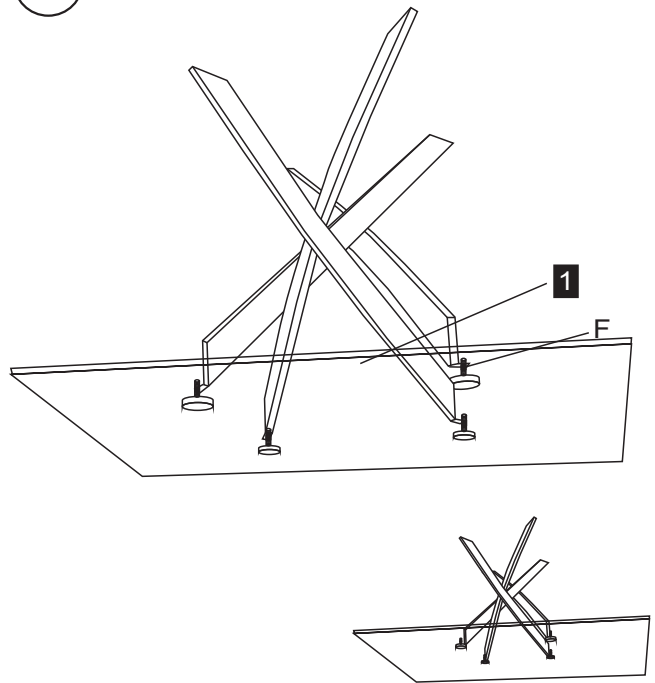

3

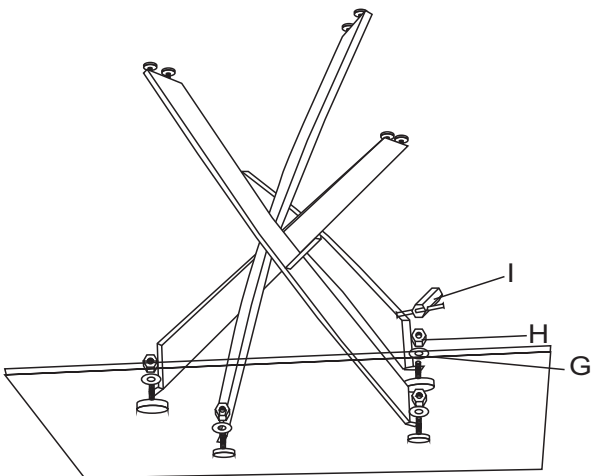

Please tighten bolts B fully after fixing nut H.

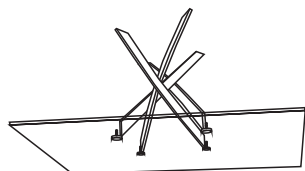

4

