

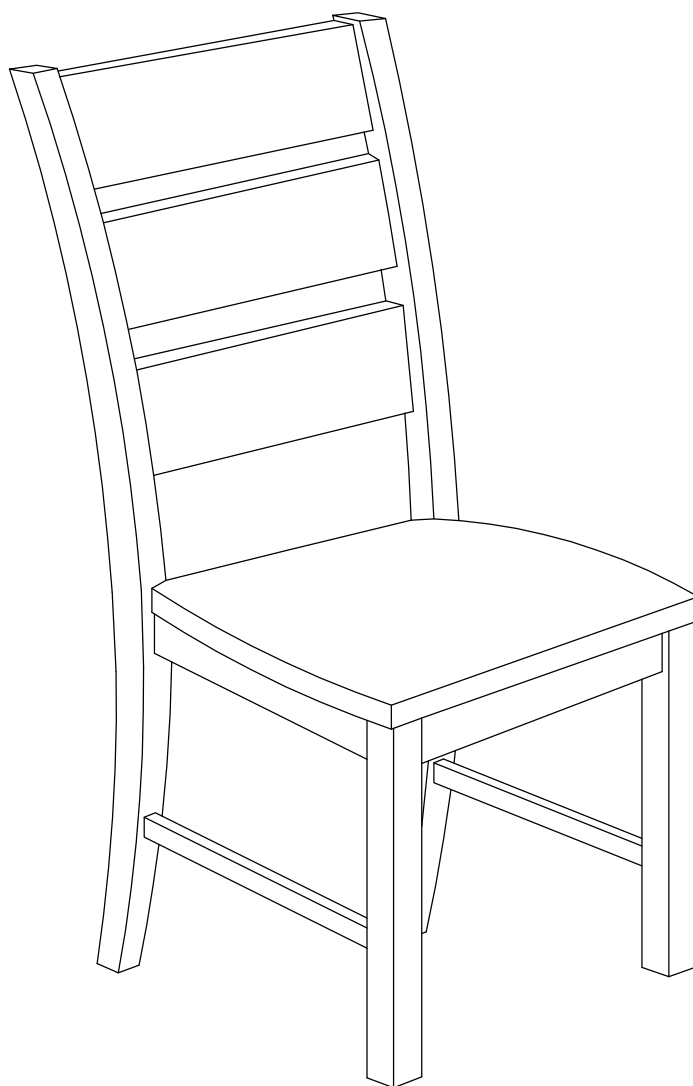



# ASSEMBLY INSTRUCTIONS / INSTRUCTIONS D'ASSEMBLAGE / INSTRUCTIVO DE ARMADO





3-00083

# NOTES ON ASSEMBLY / NOTES POUR L'ASSEMBLAGE / NOTAS SOBRE EL ENSAMBLE

- To ensure ease of assembly read all instructions before assembly and follow step by step illustrations.
- Keep instructions for future use.
- Adult assembly required.  2 person required. 
- Due to the presence of small parts during assembly, keep out of reach of children until assembly is complete.

- Pour assurer l'assemblage facile veuillez lire toutes les instructions avant l'assemblage et veuillez suivre les illustrations pour chaque etapes.
- Veuillez garder ces instructions pour l'usage ulterieur.
- Assemblage requis pas un adulte.  2 personnes requises. 
- Due a la presence de petite pieces durant l'assemblage, veuillez garder hors de porter des enfants jusqu'a ce que l'assemblage soit completer.

- Para garantizar la facilidad de ensamble lea las instrucciones antes de iniciar y siga paso a paso las ilustraciones.
- Guarde las instrucciones para futuras referencias.
- El ensamble requiere de un adulto.  2 personas requeridas. 
- Debido a que hay piezas pequeñas, mantenga fuera del alcance a los niños durante el ensamble, hasta que haya terminado.

## MAINTENANCE TIPS / CONSEILS D'ENTRETIEN / CONSEJOS DE MANUTENIMIENTO

- Never let liquids or damp cloths sit on this furniture.
  - Never use chemical cleaning products. They can damage the finish. For cleaning, use only a slightly damp cloth and wipe dry.
  - To avoid dulling of the finish, do not place furniture in direct sunlight.
  - Do not put plastic or rubber rings under appliances. Use cloth or felt protectors.
  - To clean, use a soft or slightly damp cloth, then wipe with a clean, dry cloth.
- Ne jamais laisser de liquide ou linge humide sur le meuble.
  - Ne jamais utiliser de nettoyeurs à base de produits chimiques, cela va endommager le fini. Utiliser seulement un linge légèrement humide.
  - Ne pas placer le meuble directement au soleil pour prévenir le ternissement.
  - Évitez de déposer des appareils avec des rondelles de plastique ou de caoutchouc. Utilisez un protecteur en tissu ou en feutre.
  - Pour nettoyer, utilisez un linge doux ou légèrement humecté. Essuyez par la suite avec un linge propre et sec.
- Nunca deje un líquido o un trapo húmedo sobre el mueble.
  - Nunca utilice limpiadores a base de químicos, estos dañaran le acabado. Use sólo un paño húmedo.
  - No exponga el mueble directamente al sol para prevenir empañamiento.
  - Evite apoyar aparatos con redondeles de plástico o de goma. Utilizar un protector de tela o de fieltro.
  - Para limpiar, utilice un trapo suave o ligeramente humedecido. Seque luego con un trapo limpio y seco.

# **WARNING** **AVERTISSEMENT / ADVERTENCIA**

Please use your furniture correctly and safely. Improper use can cause safety hazards, or damage to your furniture or household items.

- Follow the assembly steps in order. Do not skip any steps.
- Be sure to check all packing materials carefully for small parts may have come loose inside the carton during shipment. If parts are missing, contact the retailer from which you purchased the product to obtain any missing parts. **DO NOT USE SUBSTITUTE PARTS.**
- Periodically check to ensure that all connectors (bolts, screws, etc.) are tight.
- Keep the instruction for future reference.
- Do not stand on tables, including but not limited to, end table, coffee tables, and dinner tables, as tables are not to support the weight of a person.
- Where assembly instructions state that the assembly requires two or more people, do not attempt by yourself as there is a risk of injury.

Prière d'utiliser le mobilier à bon escient et avec prudence. Une mauvaise utilisation peut être à l'origine de risques d'accident ou peut endommager le mobilier et les articles ménagers.





- Suivez l'ordre des étapes de montage. N'en sautez aucune.
- Assurez-vous de vérifier attentivement tous les matériaux d'emballage parce que les petites pièces peuvent se détacher à l'intérieur de la boîte lors de l'expédition. Faites l'inventaire attentif de toutes les pièces. Si une ou plusieurs pièces manquent, contactez votre revendeur pour obtenir les pièces en question. **N'UTILISEZ PAS DE PIÈCES DE SUBSTITUTION.**
- Vérifiez régulièrement que tous les connecteurs (boulons, vis, etc.) sont serrés.
- Gardez ces instructions pour pouvoir les consulter ultérieurement.
- Ne vous tenez pas sur les tables, ce qui comprend mais pas uniquement, les tables d'extrémité, les tables basses, les tables à dîner, car elles ne sont pas destinées à supporter le poids des personnes.
- Lorsque les instructions de montage mentionnent que l'installation nécessite deux personnes ou plus, n'essayez pas de monter vous-même le produit, car vous risqueriez de vous blesser.

Por favor use el mobiliario correcta y seguramente. El mal uso puede causar riesgos de seguridad o daño a las unidades o artículos domésticos.

- Siga los pasos de ensamble en orden. No salte ningún paso.
- Asegúrese de comprobar con cuidado todos los materiales de embalaje en busca de piezas pequeñas que hayan podido desprenderse dentro del cartón durante el envío. Revise la lista de partes. Si faltan partes, comuníquese con el surtidor del cual usted compró el producto para obtener las partes que le faltan. **NO USE PARTES SUBSTITUTAS.**
- Periódicamente revise para asegurarse que todos los conectores (pernos, tornillos, etc.) estén bien apretados.
- Guarde las instrucciones para referencia futura.
- No se pare en las mesas, incluyendo pero sin límite a, mesas laterales, mesas de centro, mesas de comedor, ya que estas mesas no están diseñadas para soportar el peso de una persona.
- Si las instrucciones dicen que se debe usar dos o más personas no trate de armarlo solo, ya que corre el riesgo de lastimarse.

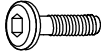
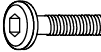
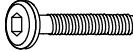
# HARDWARE

## QUINCAILLERIE / HERRAJE

(G) JCBC Bolt M6 x 35mm  3 Units	(H) JCBC Bolt M6 x 60mm  4 Units	(I) JCBC Bolt M6 x 80mm  4 Units
(J) 1/4" Spring Washer  11 Units	(K) 1/4" Flat Washer  11 Units	(L) CB Screw M4 x 38mm  4 Units
(M) Allen Key M4 x 65mm  1 Unit		

- Hardware quantity may supplied more than it required. Please keep spares and tools for future use.
- La cantidad de hardware puede suministrarse más de lo requerido. Guarde los repuestos y las herramientas para uso futuro.
- La quantité de matériel peut fournir plus que nécessaire. Veuillez conserver les pièces de rechange et les outils pour une utilisation future.

## TOOLS NOT INCLUDED

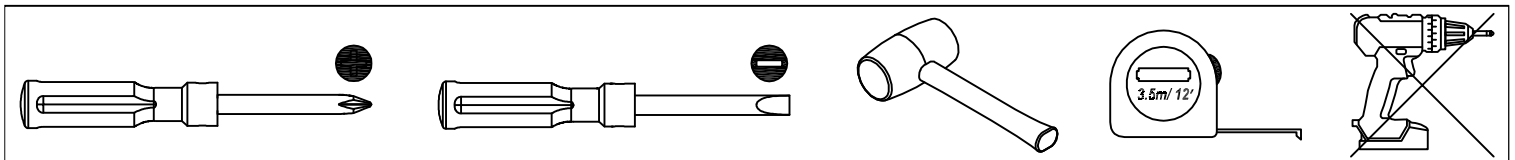

### OUTILS PAS INCLUS / HERRAMIENTAS NO INCLUIDAS

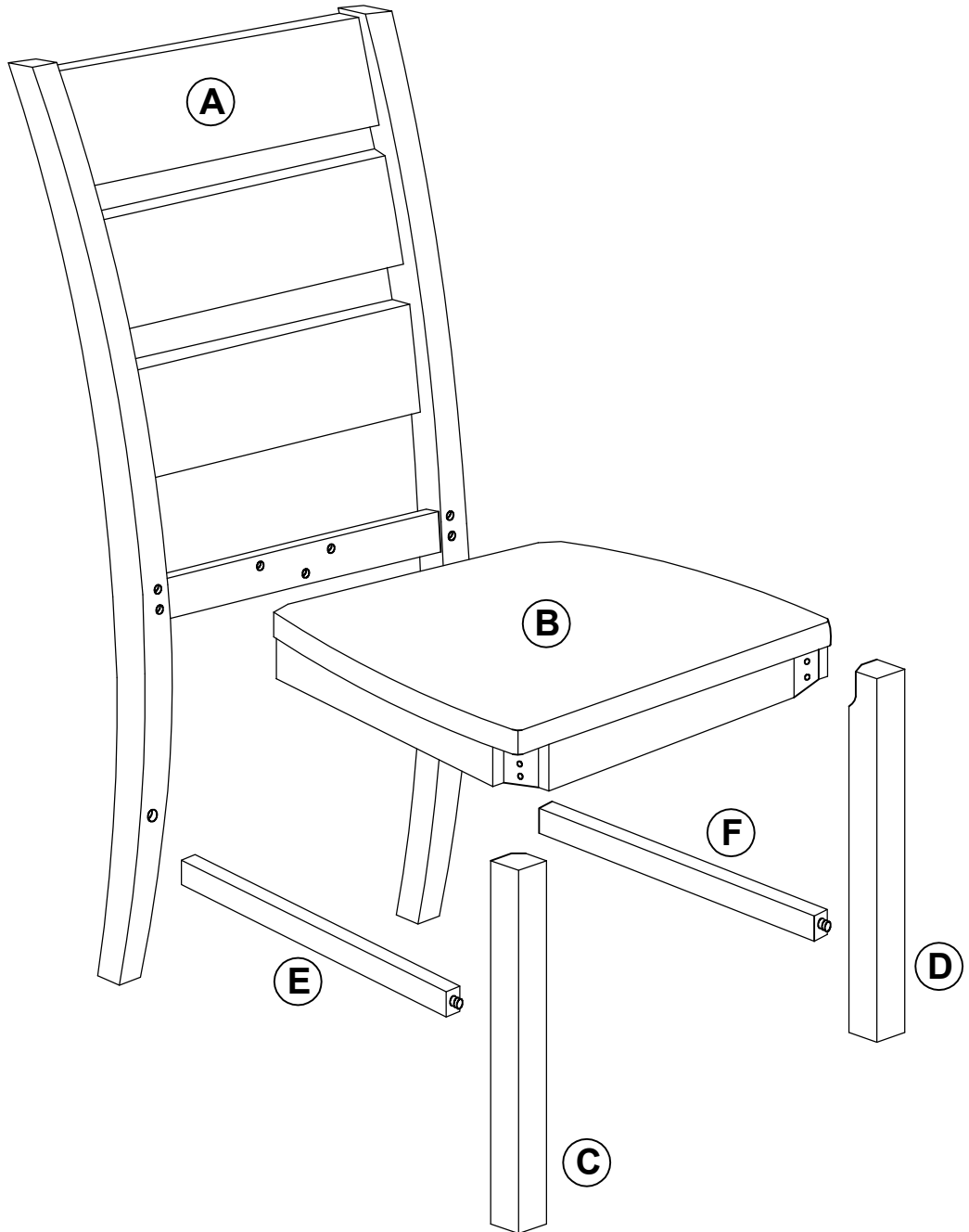

# PARTS IDENTIFICATION / IDENTIFICATION DES PIÈCES / IDENTIFICACIÓN DE LAS PARTS



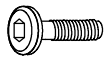

# STEP 1

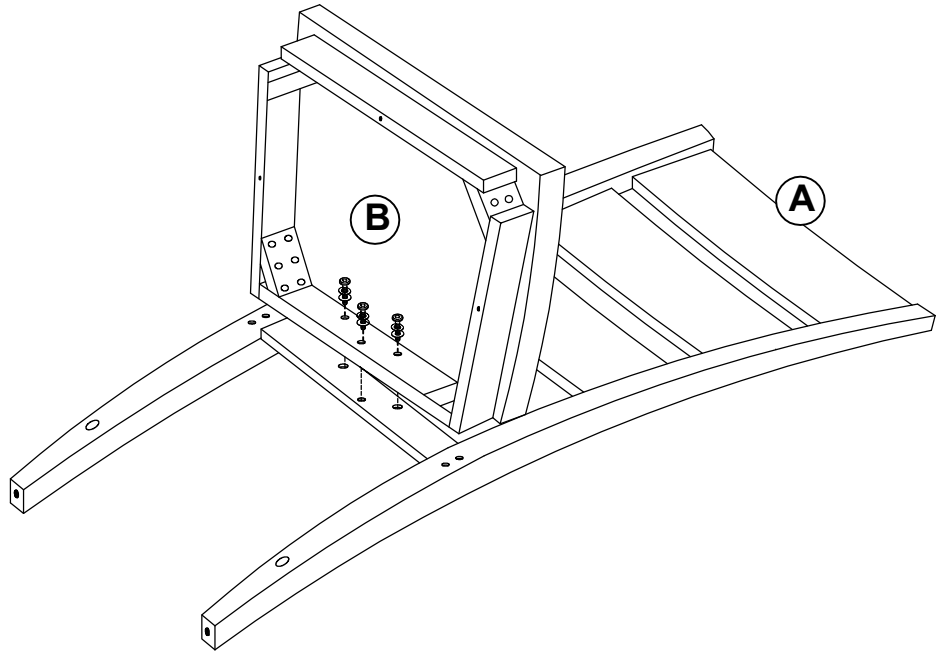
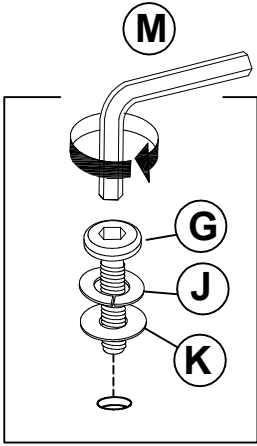
		
G x 3	J x 3	K x 3



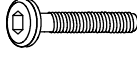

# STEP 2

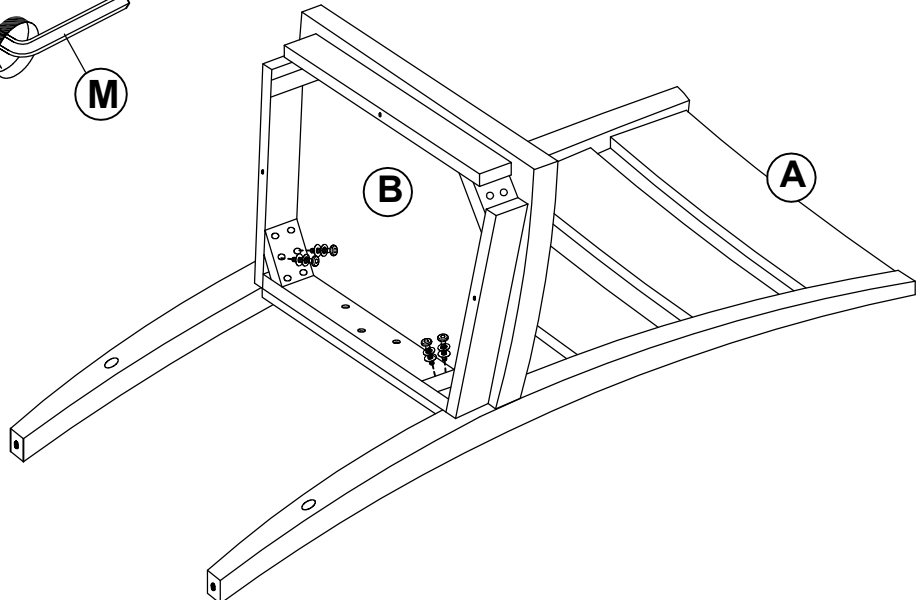
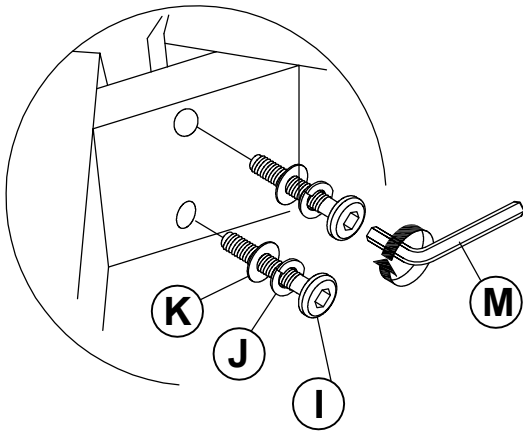
		
I x 4	J x 4	K x 4

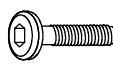

# STEP 3

\*Do not fully tighten on this step\*

		
H x 4	J x 4	K x 4

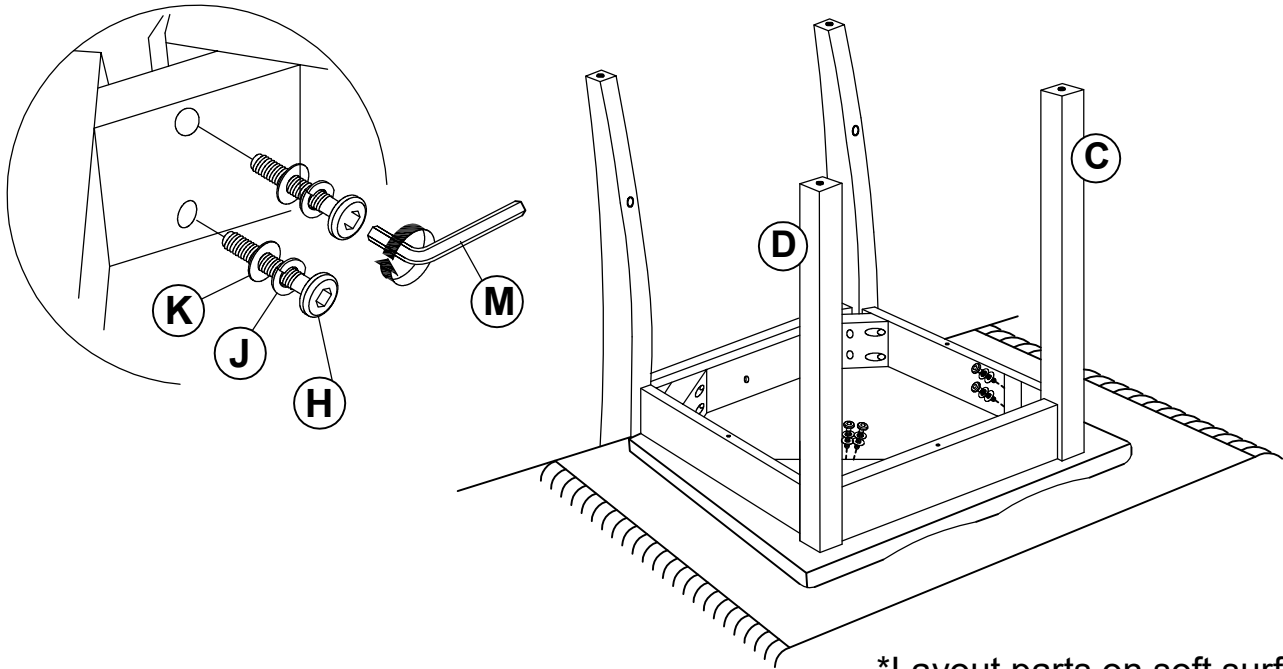

\*Layout parts on soft surface\*

# STEP 4

\*Fully tighten all the bolt and screw\*

L x 4

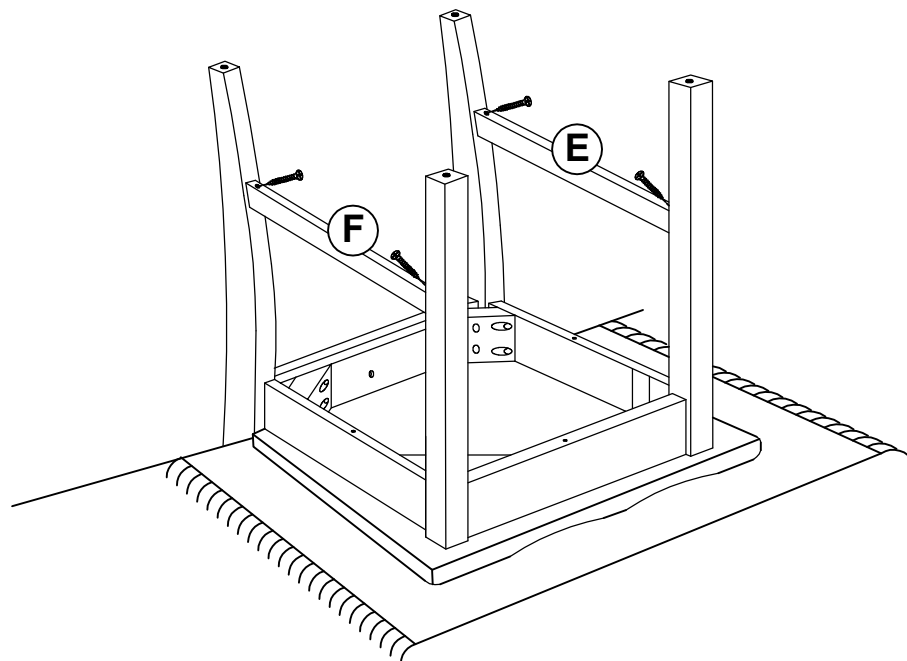
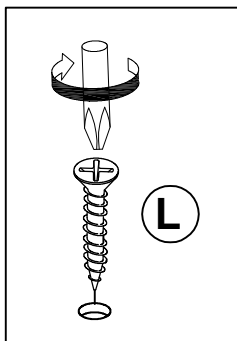

# MAXIMUM LOADS CHARGES MAXIMALES / CARGA MAXIMA

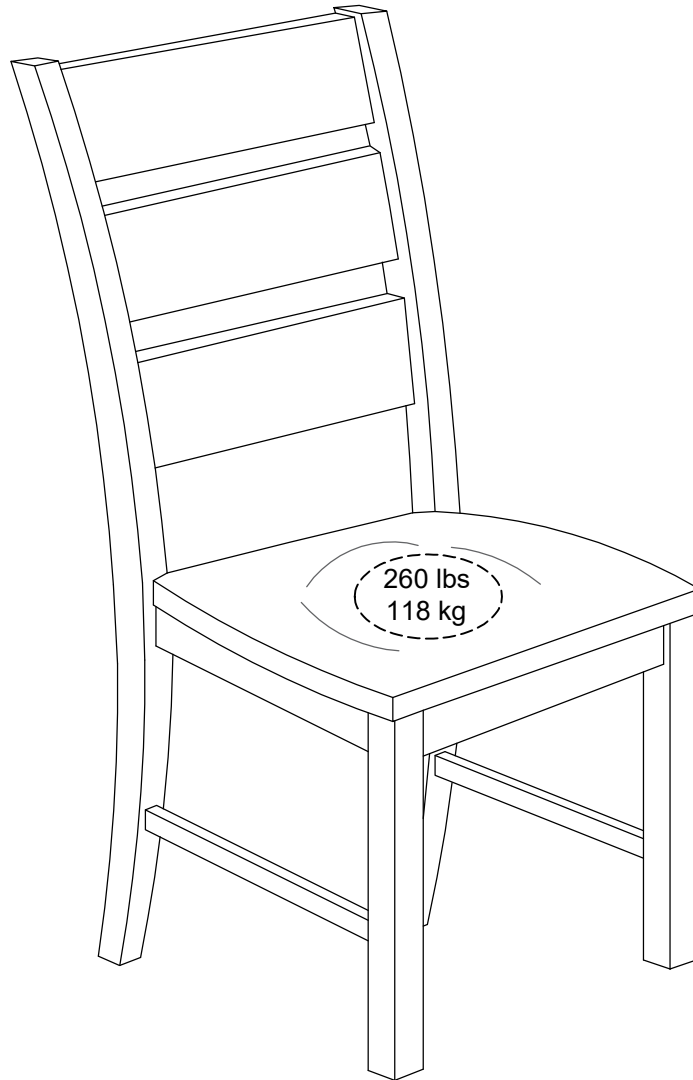

---

This unit has been designed to support the maximum loads shown. Exceeding these load limits could cause sagging, instability, product collapse, and/or serious injury.

---

Ce meuble a été conçu pour supporter les charges maximales indiquées. En excédant ces limites de charge, le meuble pourrait devenir instable, s'effondrer, et/ou causer des blessures graves.

---

Esta unidad ha sido diseñada para soportar la carga máxima anotada. El exceder estos límites puede causar inestabilidad, colapsarse y/o causar serias lesiones.

---