

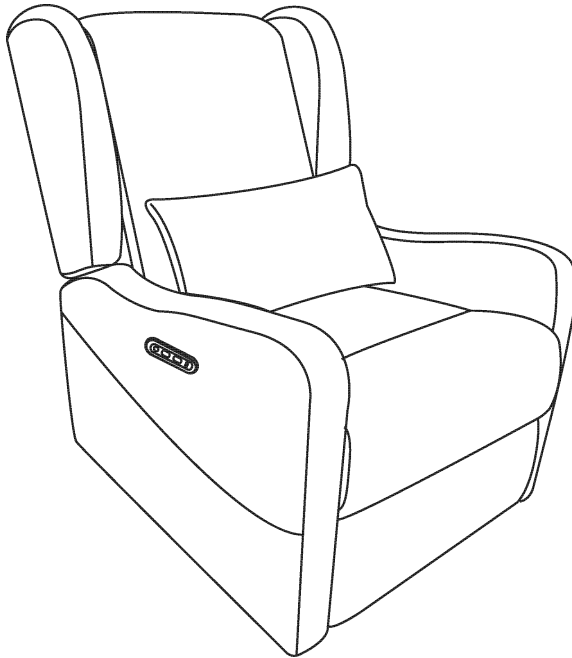

Owner Manual



NOTE:

This brochure contains **IMPORTANT** safety info. Please read and keep for future reference.

Maintenance and Warning

- We suggest you spend a short time reading through this leaflet and then follow the simple step-by-step instructions.
- Carefully check that you have all the parts before beginning assembly.
- Keep fittings out of children's reach and keep children well away from construction area.
- We suggest you retain these instructions for future reference.
- Keep furniture away from heat sources.
- Do not clean furniture with harsh cleaners or polishes.
- Do not use detergents, solvents, abrasives, spray packs or leather cleaners.
- Use non-color mild soap with warm water to clean spills (Mix 1:10 soap to water).
- Do not place furniture under direct sunlight, material will possibly fade over time.
- Do not use an on-site dry cleaning machine.
Children should not climb or jump on the furniture.
- Do not write on furniture that is not protected by a padded barrier.
- Not for commercial use, only for residential use.

Parts List



A Backrest x 1

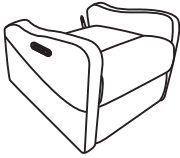

B Seat Cushion x 1



C Right ear x 1



D Left ear x 1



E Lumbar Pillow x 1

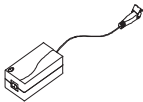

F Adapter x 1



G Plug x 1

ASSEMBLY INSTRUCTION

Step 1

Open the package and cut the holding string.

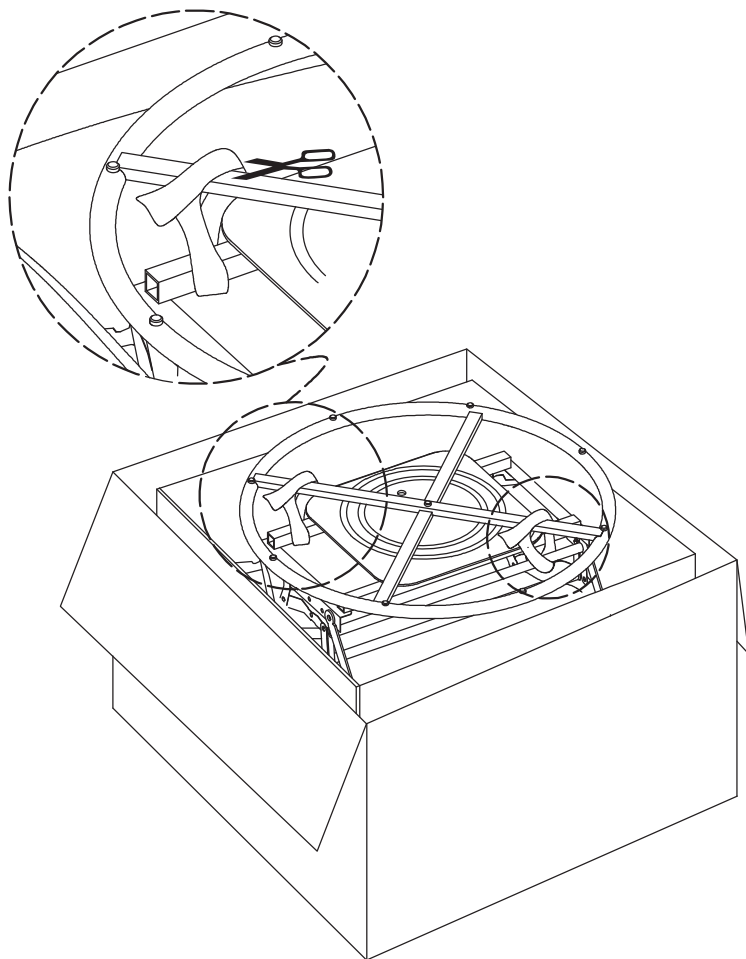

Step 2



NOTE:

Be sure to have an adult partner help.

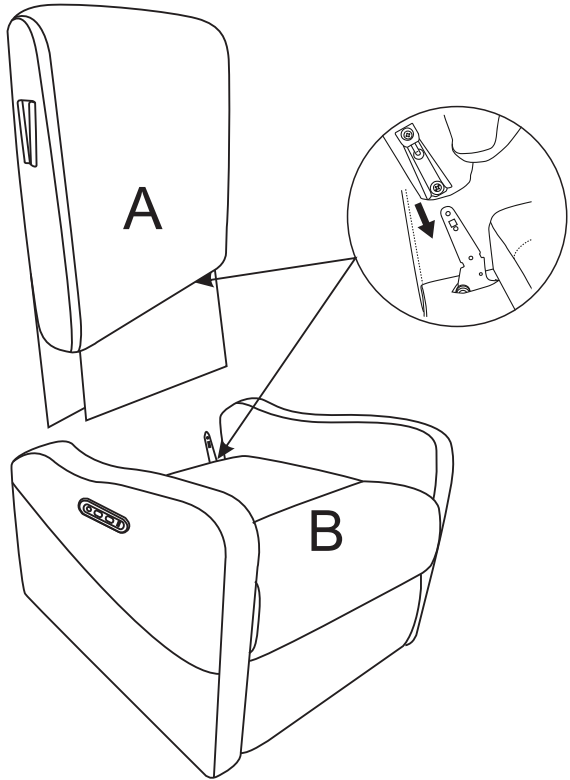

Step 3

Hold both armrests while aligning metal brackets on backrest or armrests.

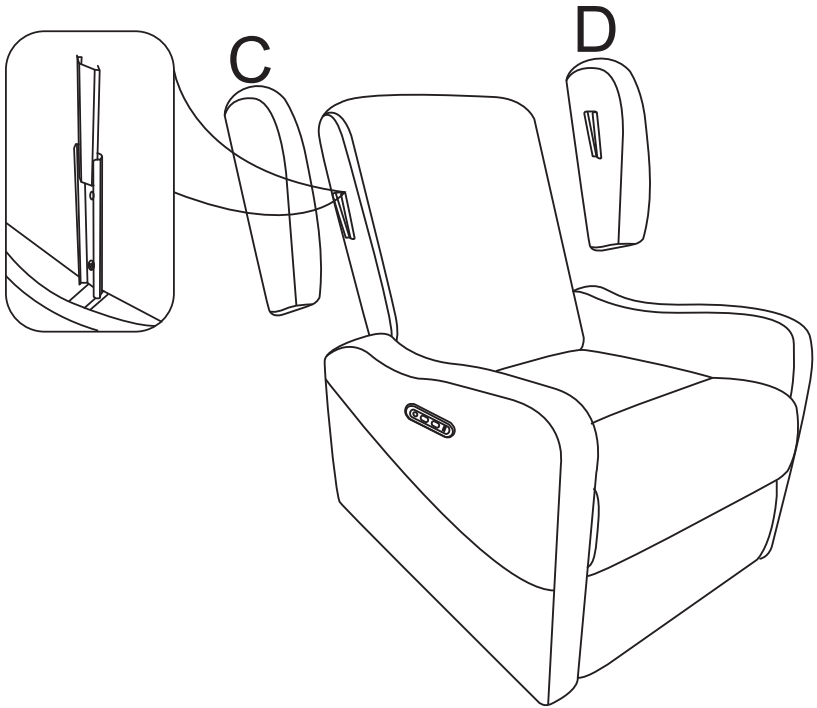

Step 4

Cover the back cloth.

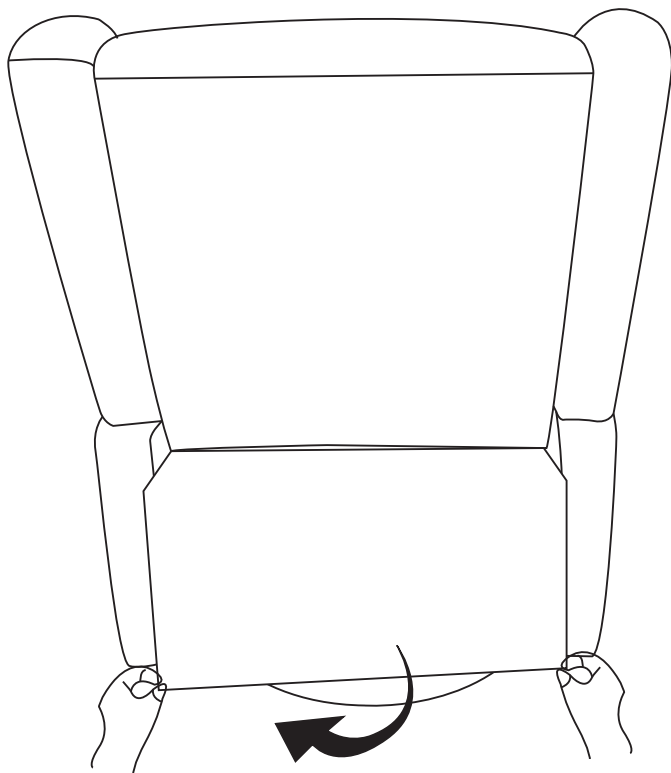

Step 5

Connect the power cord.

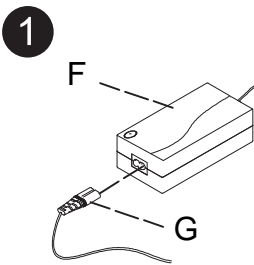
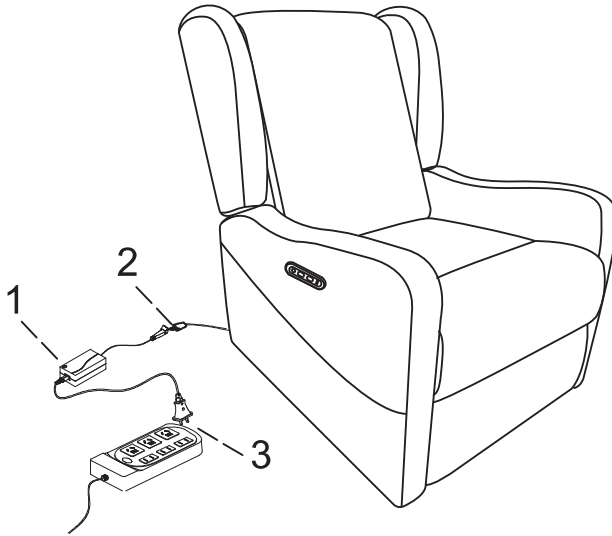

Connect D and E.

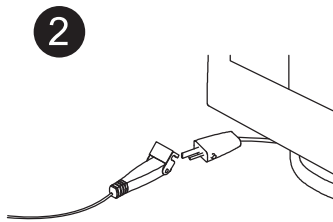

Connect the adapter cable to the bottom cable of the sofa.

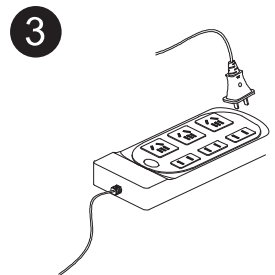

Power on the plug.

Step 6

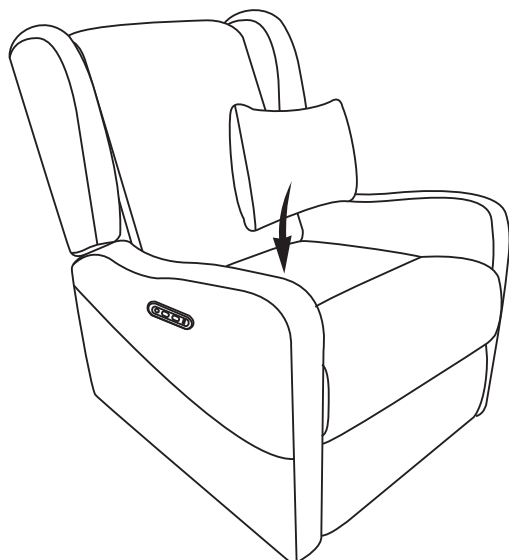
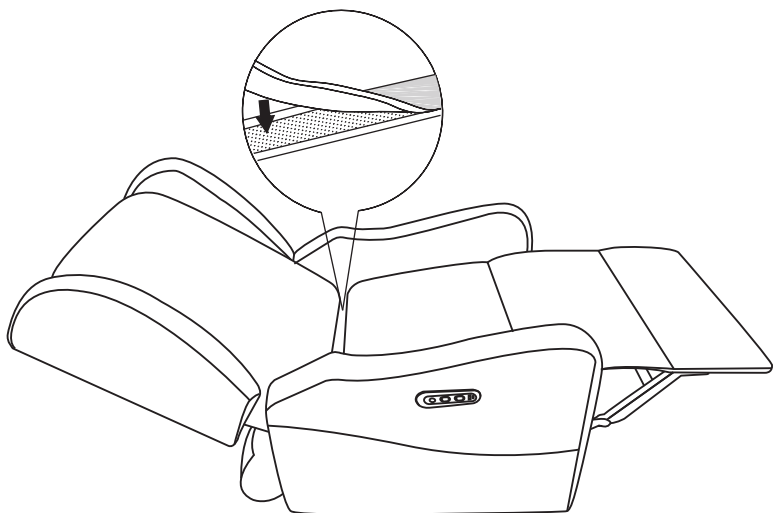

Adjust the Angle through Buttons

The backrest can be tilted from 105 to 140 degrees.

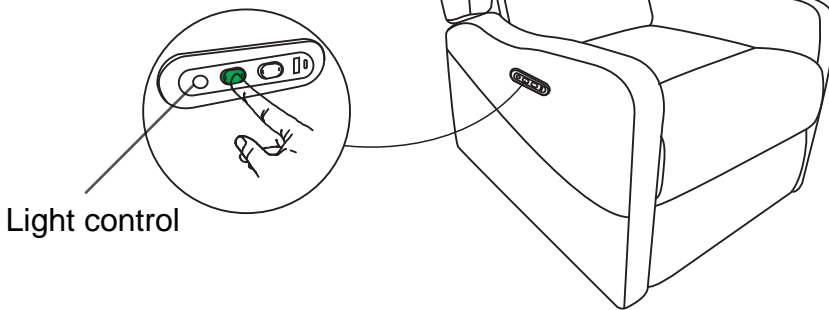
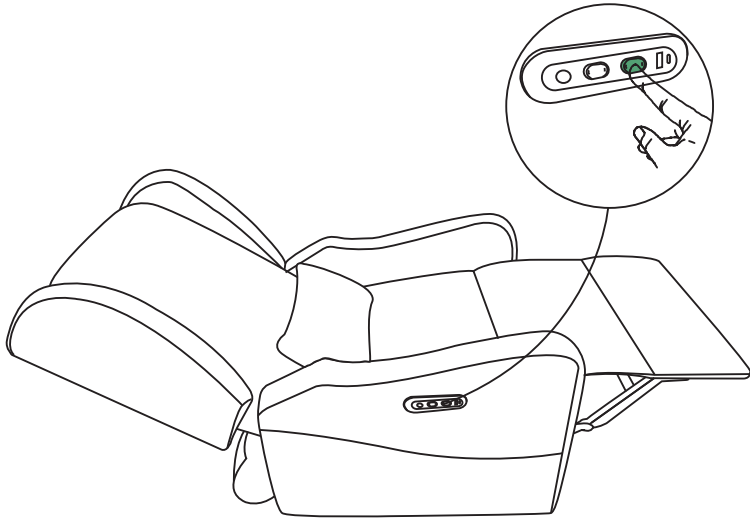

It offers a cozy spot for feeding, soothing, and relaxation.

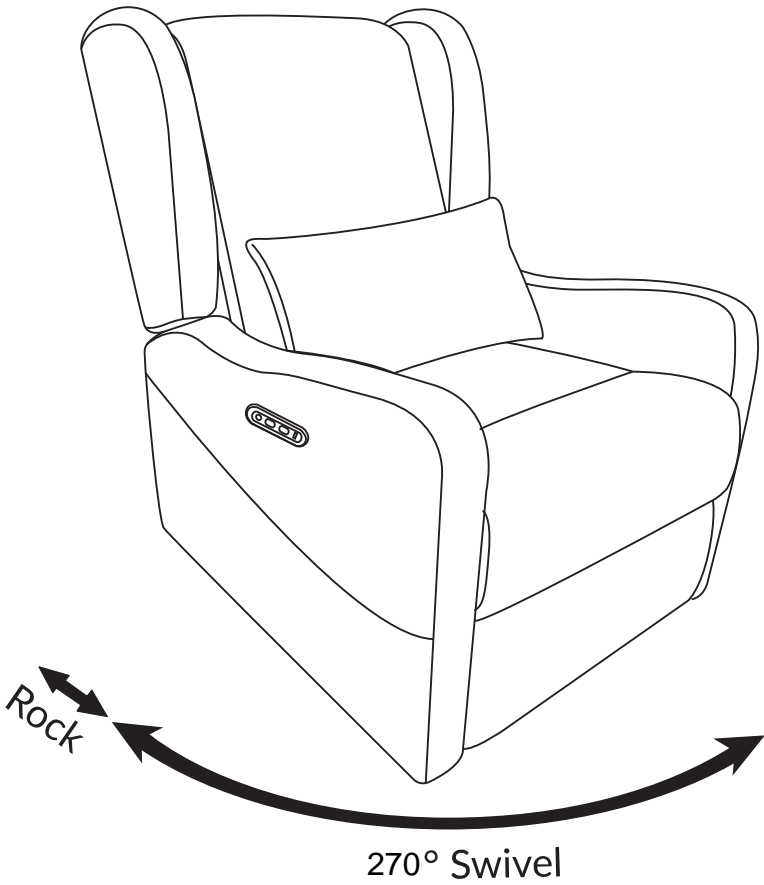

MATTERS NEEDING ATTENTION

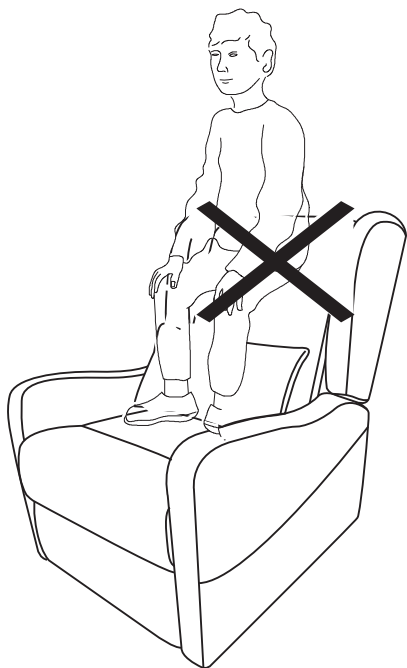

NOTE:
Do not sit on the backrest!



NOTE:
Do not sit on the armrest!

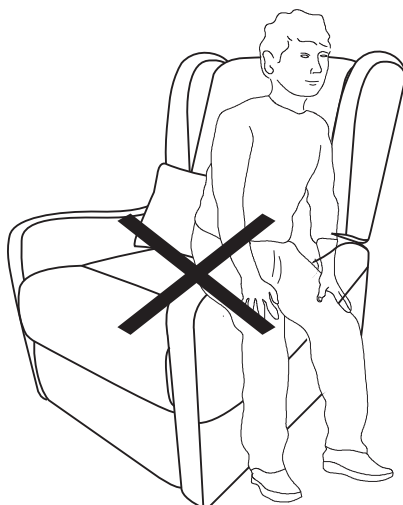



NOTE:

Do not sit on the foot pedal!

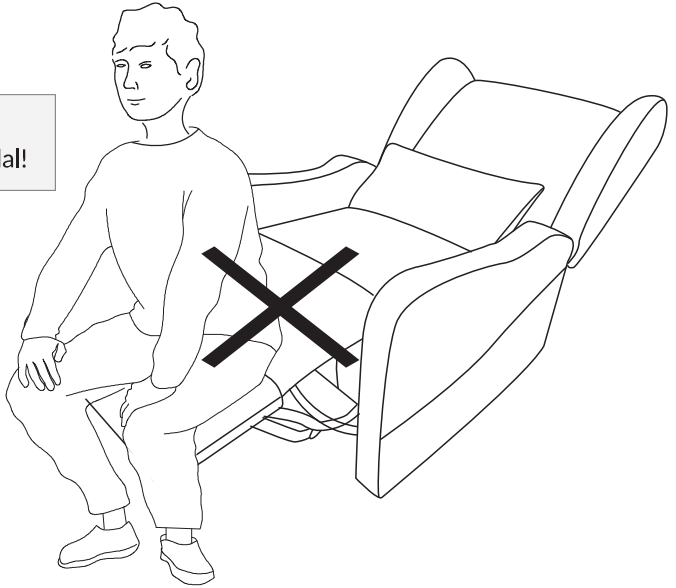

NOTE:

Do not place legs on handrails!

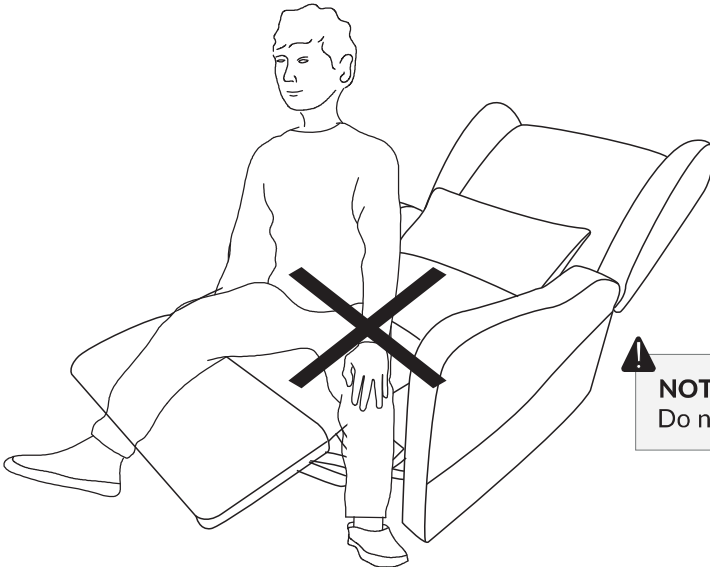

WARRANTY

- We strive to offer quality products, and we also try our best to satisfy every customer who orders from us with products or services as needed.
- We provide 30 days warranty starting from the time you receive the item. Each customer must provide a record of their orders such as the order number, or item receipt for any items that are out of the warranty period you may also still receive.
- Replacement parts by purchasing them from our company if they are available.