







1	1x
2	1x
3	1x
4	1x
5	1x

<p>A</p>  <p>M6*45MM 4x</p>	<p>B</p>  <p>M6*35MM 3x</p>	<p>C</p>  <p>M6*13MM 4x</p>	<p>D</p>  <p>1x</p>	<p>E</p>  <p>1x</p>	<p>F</p>  <p>M6*13MM 4x</p>
<p>G</p>  <p>4x</p>					

I.

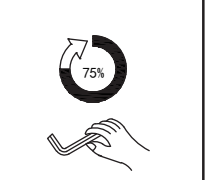
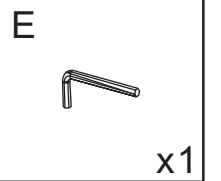
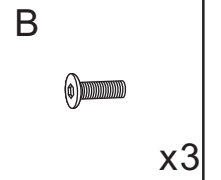
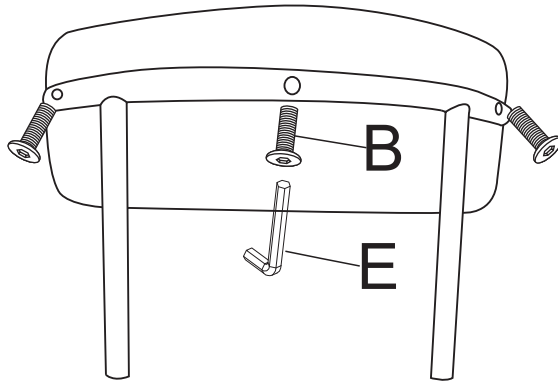

II.

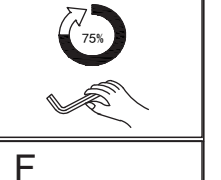
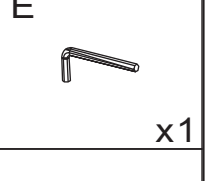
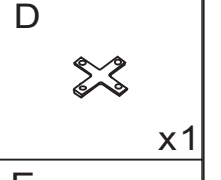
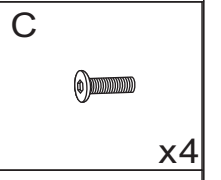
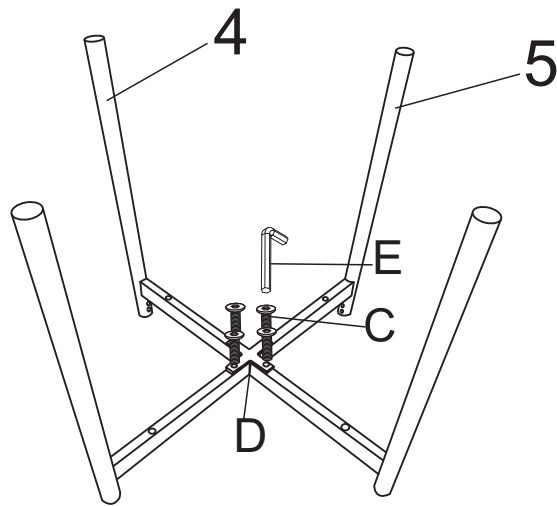

III.

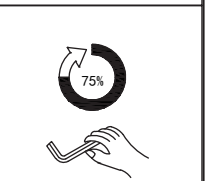
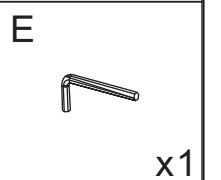
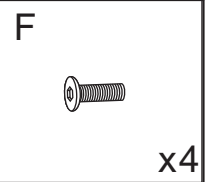
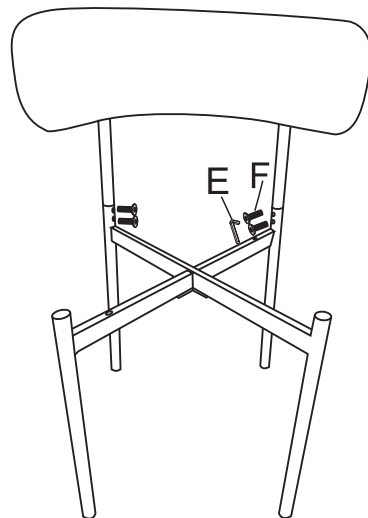

V

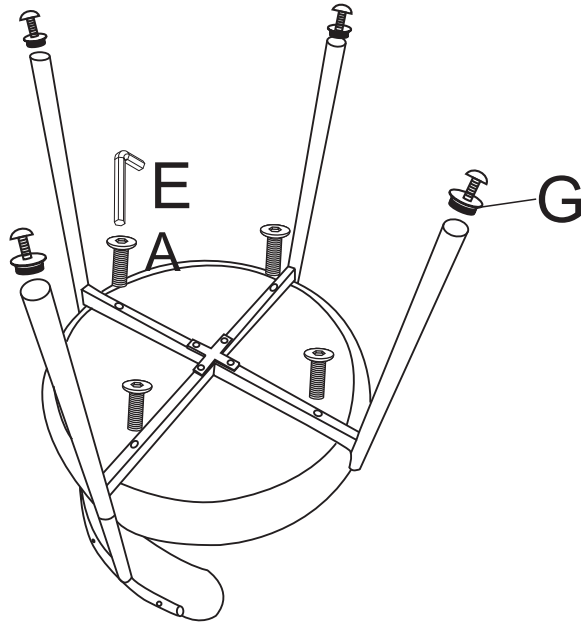

A



x4

E



x1

G



x4



VI

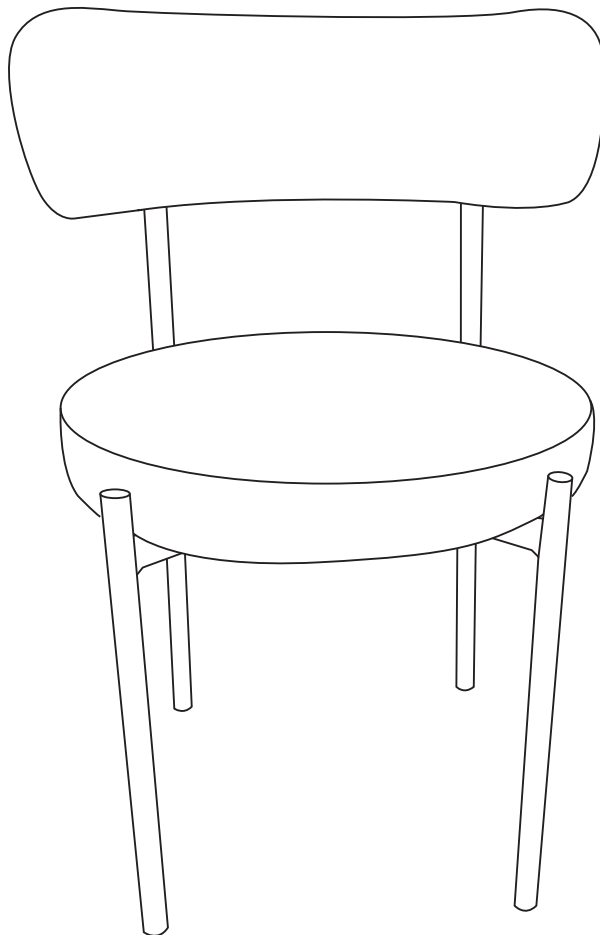

E



x1

