

## WARNING

- \* Switch off the main electrical supply from the main fuse box / circuit breaker before installation.
- \* Inspect item carefully before attempting to install.
- \* If there is any damages or obvious defects, do not install.
- \* Item may not be returned once it has been installed.













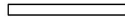



## CARE AND MAINTENANCE

- \* To clean the outside of the fixture, use a dry or slightly dampened clean cloth (use clean water, never a solvent) to wipe the surface of the fixture.
- \* To clean the inside of the fixture, first disconnect power to the fixture by turning off the circuit breaker or by removing the fuse at the fuse box. Next, use a dry or slightly dampened clean cloth (use clean water, never a solvent) to wipe the interior surface of the fixture.
- \* Do not use any cleaners with chemical, solvents or harsh abrasives. Use only a dry soft cloth to dust or wipe carefully.

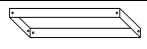
## NOTICE& IMPORTANT SAFETY INSTRUCTIONS

- \*\* WE RECOMMEND INSTALLATION OF THIS LIGHTING FIXTURE BE DONE BY A LICENSED ELECTRICIAN \*\*
- \* Please make sure that you have all parts indicated before you begin assembly of this item
- \* This item should be assembled on a soft surface to prevent scratching the finish during assembly
- \* To reduce the risk of fire, electrical shock or injury to persons or property, please follow the guideline below for safe use and installation
- \*The external flexible cable or cord of this lamp cannot be replaced  
If the cord is damaged, the lamp shall be destroyed

### Part List and Hardware List

PIECE	DESCRIPTION	PICTURE	QUANTITY	PIECE	DESCRIPTION	PICTURE	QUANTITY
A	Mounting Plate		1X	J	Top frame		1X
B	Mounting Screw		2X	L	rod		1X
C	Wire Nut		3X	M	Flat head Phillips screw		16X
D	canopy		1X	N	bulb		6X
E	Hanging Loop		1X	P	Frame support rod		4X
F	Canopy Nut		1X	Q	Bottom frame		1X
H	Chain		1X	R	Lamp holder		1X
G	Closable Link		2X		screwdriver		1X
I	Round loop		1X				

**Product Dimensions: 16"L X 16"W X 27-86"H**

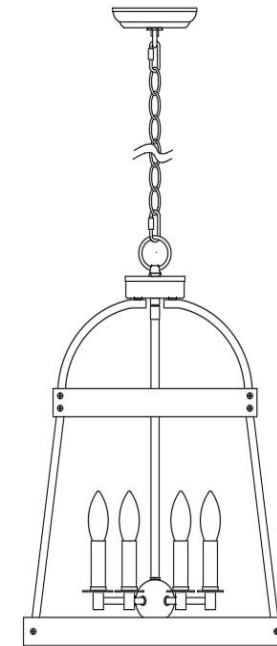

# PREPARATION

\* Before beginning assembly of product, make sure all parts are present. Compare parts with package contents list and hardware contents list.

\* If any part is missing or damaged, do not attempt to assemble the product.

\* Estimated Assembly Time: 20 minutes.

\* Tools Required for Assembly (not included): Screwdriver, Junction box

\* If you are having difficulty, our friendly Customer Care team is always here to help.

**NOTE: PLEASE USE TYPE "B" BULB MAX 40-WATT OR LED BULB MAX 9-WATT, THERE ARE 6\* LED 4-WATT BULB IN THE BOX**

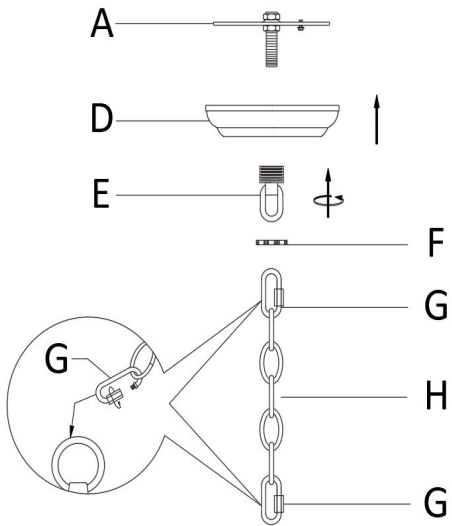

**Step 1:** Unpack all parts from cartons carefully. Place the Canopy(D) onto the Hanging Loop(E)  
Place the tube of Mounting Plate(A) into the threaded portion of the Hanging Loop(E) and fix it by turning the Canopy Nut(F) clockwise till tight.  
Attach the Closable Link(G) onto the Hanging Loop(E)

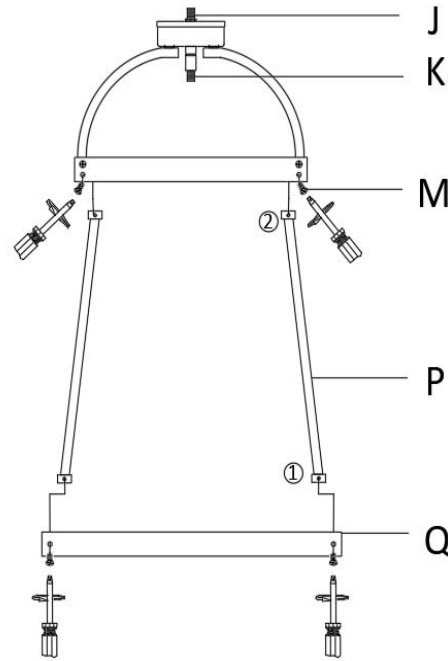

**Step 2:** Install Top frame(I) and Bottom frame(Q) with Frame support rod(P), using screw driver fasten these parts by Flat head Phillips screw(M)

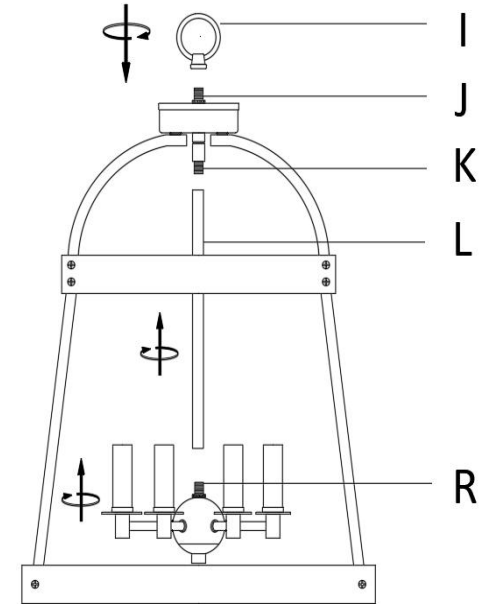

**Step 3:** Connecting lamp body with Lamp holder(R) by Rod(L) of the swivel and turn clockwise until firmly tightened. Fasten Round loop(H) on Top frame (J) nipple.

# PREPARATION

- \* Before beginning assembly of product, make sure all parts are present. Compare parts with package contents list and hardware contents list.
- \* If any part is missing or damaged, do not attempt to assemble the product.
- \* Estimated Assembly Time: 20 minutes.
- \* Tools Required for Assembly (not included): Screwdriver, Junction box
- \* If you are having difficulty, our friendly Customer Care team is always here to help.

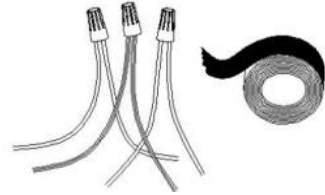
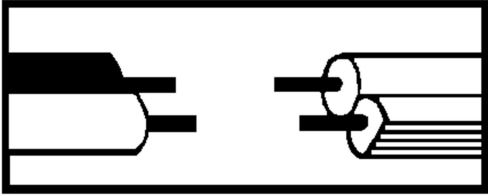

## Step 4: Wire connection

Connect fixture neutral wire (ribbed) to the outlet box neutral wire (usually white) using a wire nut. Connect fixture hot wire (smooth with markings) to the outlet box hot wire (usually black) using a wire nut. CAUTION: Do not reverse the hot and neutral connections

## Grounding Instructions:

Wrap ground wire from outlet box around green ground screw on mounting bracket, no less than 2" from wire end. Tighten ground screw. If fixture is supplied with a ground wire, connect to outlet ground wire with a wire connector.

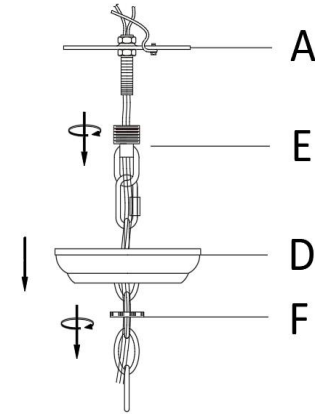

**Step 5:** Install the Mounting Plate(A) to the junction box with Mounting Screw (B). Separate the Mounting Plate(A) from the Canopy(D) by turning the Canopy Nut(F) anti-clockwise.

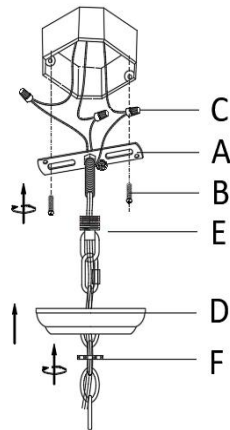

**Step 6:** Attach the Canopy(D) to the junction box and fix it by turning the Canopy Nut(F) clockwise.

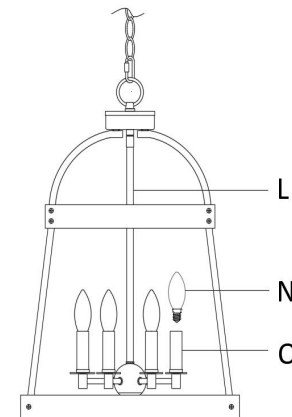

**Step 7:** Insert the bulbs (N) into the Sockets