

# ASSEMBLY INSTRUCTION

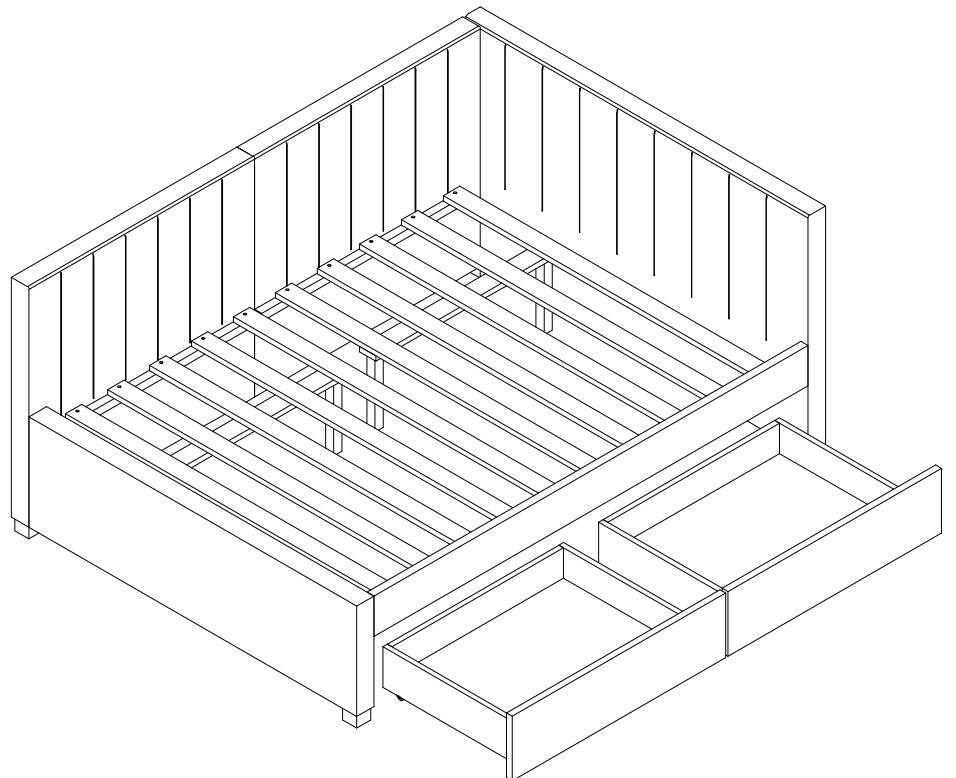

# Detail View - FULL BED WITH TWO DRAWERS

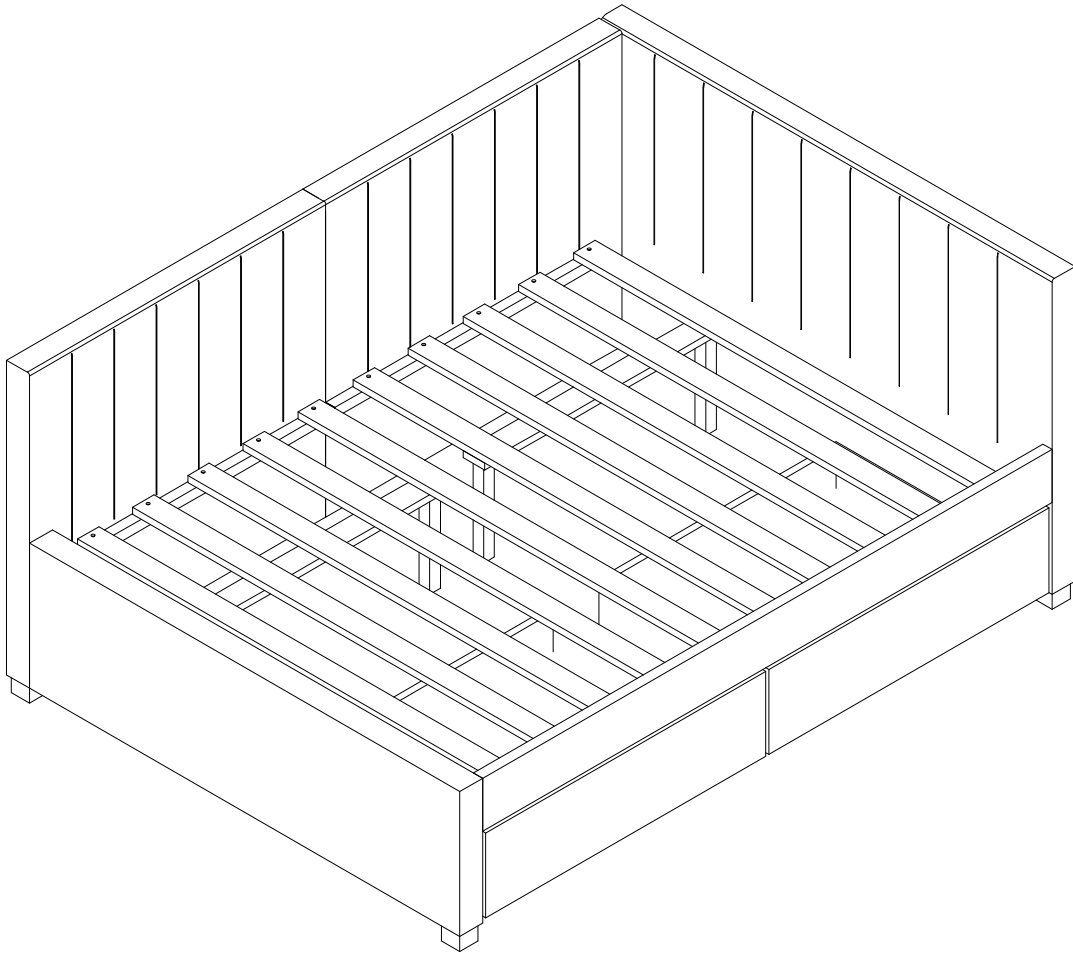

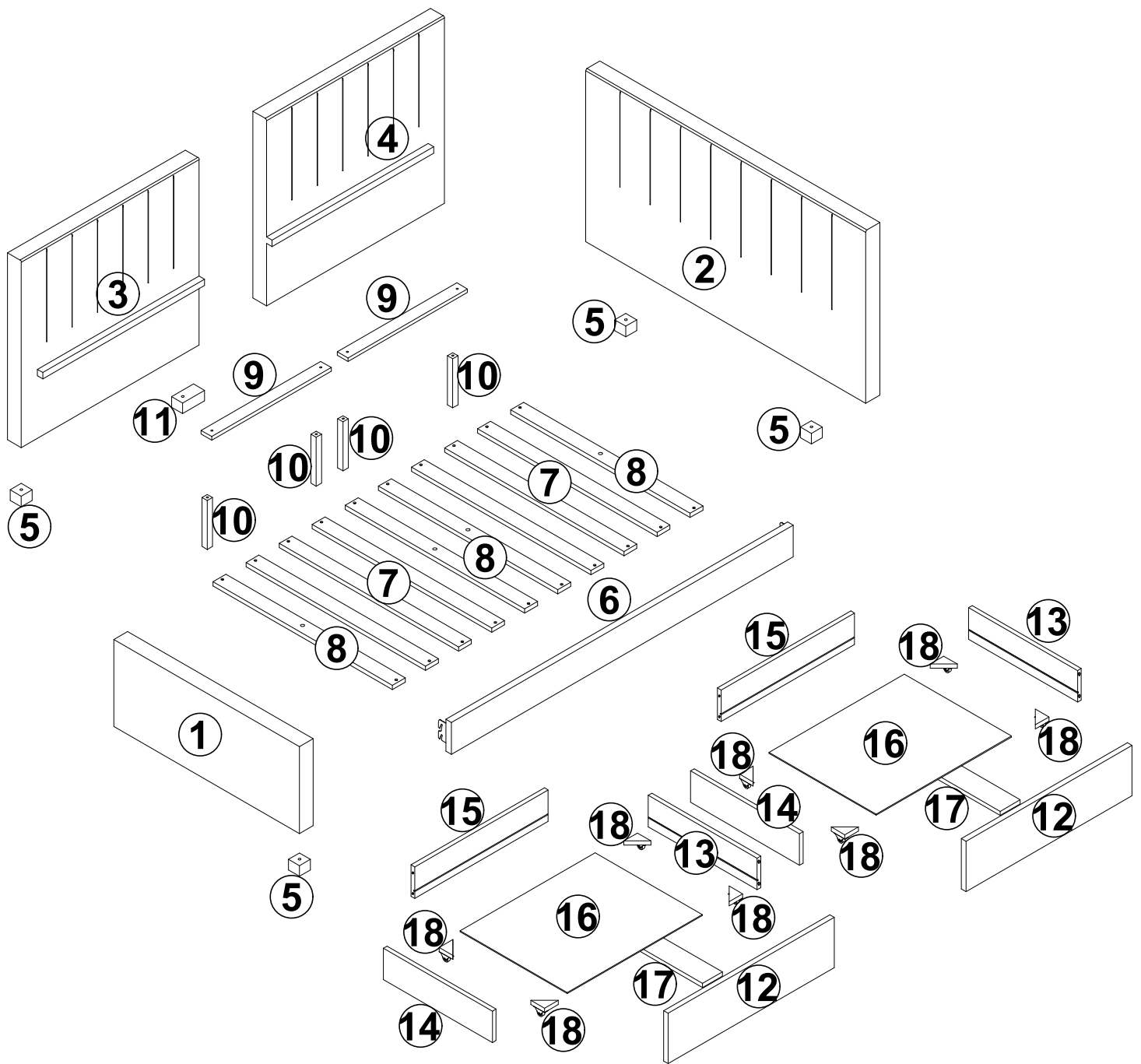

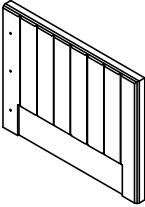
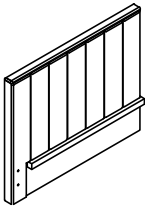
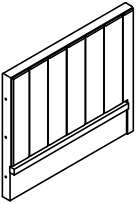
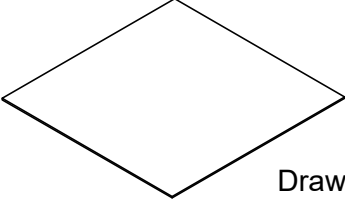

Identifying the Hardware - Identify the hardware using the illustrations below.



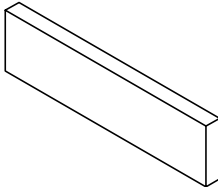

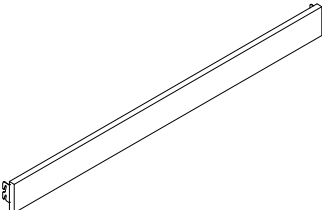
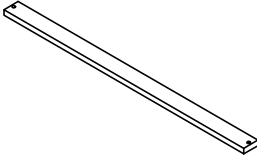
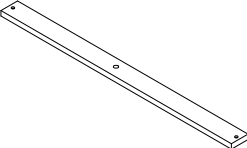
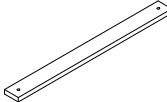

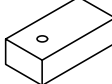
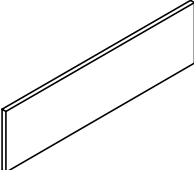
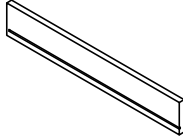
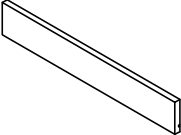
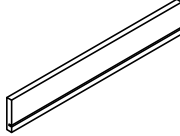
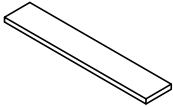
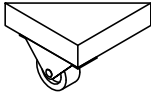



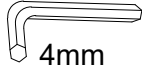
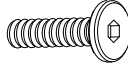
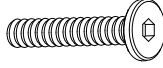
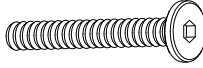

# Part Lists:

|           |   |                      |
|-----------|---|----------------------|
| <b>2</b>  |    | Headboard-1pc        |
| <b>3</b>  |  | Back panel 1 - 1pc   |
| <b>4</b>  |    | Back panel 2 -1pc    |
| <b>16</b> |   | Drawer bottom - 2pcs |

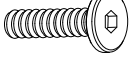
# Part Lists:

|   |   |
|---|---|
| <p><b>1</b></p>  <p>Footboard-1pc</p>                      | <p><b>5</b></p>  <p>Bed leg -4pcs</p>              |
| <p><b>6</b></p>  <p>Side rail -1pc</p>                     | <p><b>7</b></p>  <p>Bed slat 1 - 6pcs</p>          |
| <p><b>8</b></p>  <p>Bed slat 2 - 4pcs</p>                  | <p><b>9</b></p>  <p>Middle crossbar -2pcs</p>       |
| <p><b>10</b></p>  <p>Support leg -4pcs</p>                 | <p><b>11</b></p>  <p>Back bottom leg -1pc</p>      |
| <p><b>12</b></p>  <p>Drawer front - 2pcs</p>             | <p><b>13</b></p>  <p>Right drawer side - 2pcs</p> |
| <p><b>14</b></p>  <p>Left drawer side - 2pcs</p>         | <p><b>15</b></p>  <p>Drawer back - 2pcs</p>      |
| <p><b>17</b></p>  <p>Drawer bottom support bar -2pcs</p> | <p><b>18</b></p>  <p>Wheel support - 8pcs</p>    |

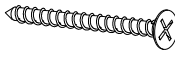
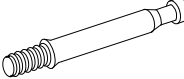
## HARDWARE LISTS:

|  |  |          |  |
|--|--|----------|--|
| <b>A</b>   | <br>4mm<br>Allen key (1pc)                | <b>B</b> | <br>Ø5/16" x 20mm<br>Hex-head bolt (4pcs) |
| <b>C</b>   | <br>Ø5/16" x 40mm<br>Hex-head bolt (6pcs) | <b>D</b> | <br>Ø5/16" x 50mm<br>Hex-head bolt (5pcs) |
| <b>E</b>   | <br>Ø5/16"<br>Spring washer (15pcs)       | <b>F</b> | <br>Ø5/16"<br>Flat washer(15pcs)          |
| <b>G</b>   | <br>Ø5/16" x 70mm<br>Hanger bolt (2pcs)   | <b>H</b> | <br>Half moon (2pcs)                      |
| <b>I</b>   | <br>Ø5/16"<br>Nut (2pcs)                  | <b>J</b> | <br>Wrench (1pc)                          |
| <b>K</b>   | <br>Ø1/4" x 45mm<br>Hex-head bolt (4pcs)  | <b>L</b> | <br>Ø1/4" x 50mm<br>Hex-head bolt (8pcs)   |
| <b>M</b>   | <br>Ø1/4"<br>Spring washer (4pcs)       | <b>N</b> | <br>Ø1/4"<br>Flat washer(4pcs)          |
| <b>Q</b>   | <br>Ø1/4"<br>Barrel nut (8pcs)          | <b>R</b> | <br>Ø4 x 30mm<br>Wood screw (44pcs)     |
| <b>S</b>   | <br>Cam bolt (8pcs)                     | <b>T</b> | <br>Cam lock(8pcs)                      |
|  |  |          |  |
| <b>ASSEMBLY TOOLS REQUIRED ( NOT INCLUDED )</b>                                      |  |          |  |

Read this instruction carefully. See hardware and furniture part list for guidance. Be sure all parts are complete, before you assemble. Place all wooden furniture parts on a clean and flat soft surface to prevent from being scratched.



Follow the figure to start assembling.

### CAUTIONS :

1. Do not FULLY - TIGHTEN the nut or nut bolt until all nut or bolt is ready assembled.
2. Do not OVER - TIGHTEN the nut or bolt to avoid causing damages to the thread.
3. Keep all hardware parts out of reach of children.

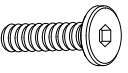

**NOTE : THE LIST AND QUANTITY SHOWN ARE FOR 1 UNIT ASSEMBLY.**

**STEP 1**

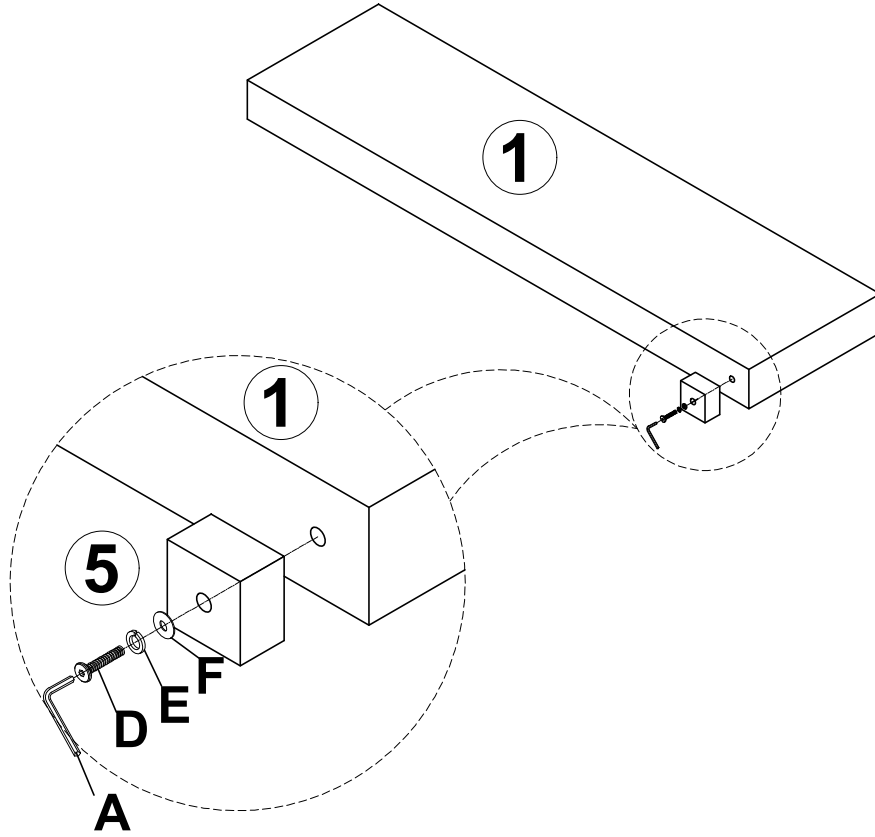
|          |  |          |  |          |  |
|----------|--|----------|--|----------|--|
| <b>F</b> |  | <b>E</b> |  | <b>D</b> |  |
|          | 1PC  |          | 1PC  |          | 1PC  |



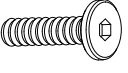

**STEP 2**

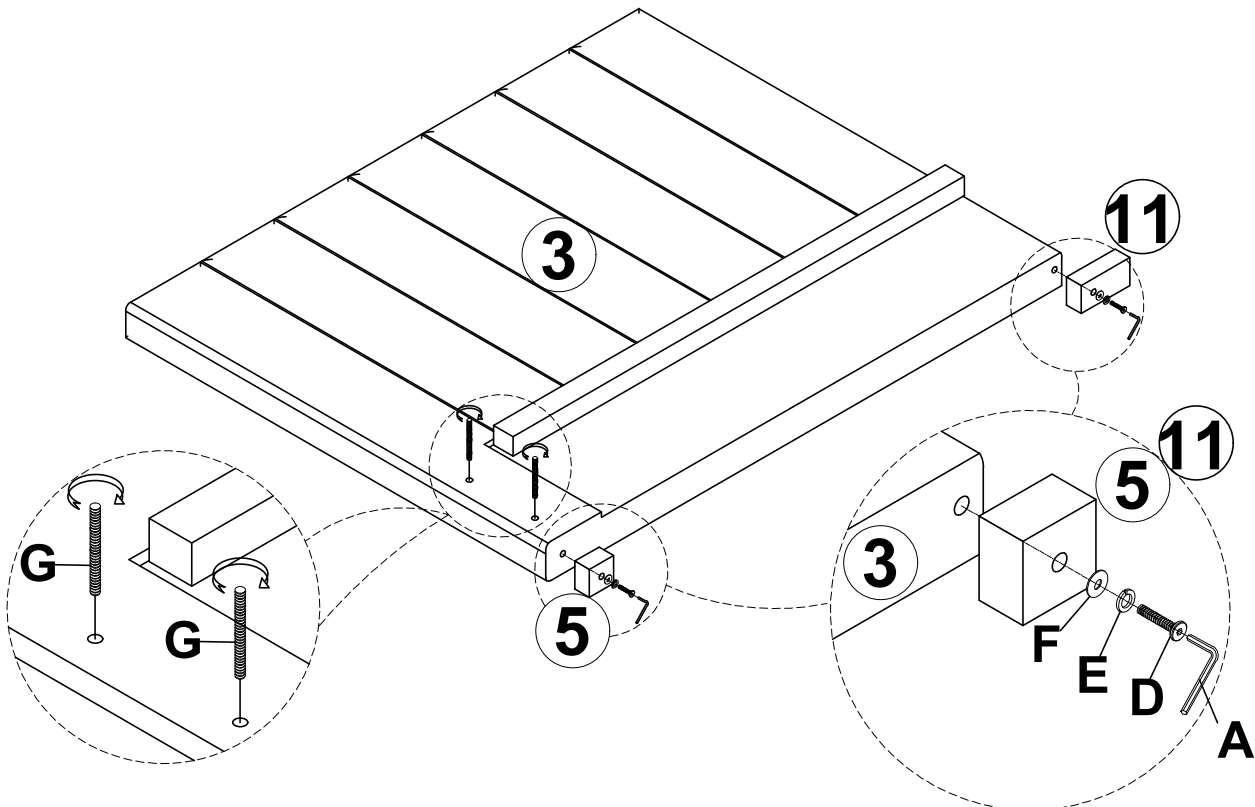
|          |   |          |   |          |   |          |   |
|----------|---|----------|---|----------|---|----------|---|
| <b>G</b> |  | <b>F</b> |  | <b>E</b> |  | <b>D</b> |  |
|          | 2PCS  |          | 2PCS  |          | 2PCS  |          | 2PCS  |



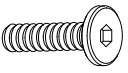

# STEP 3

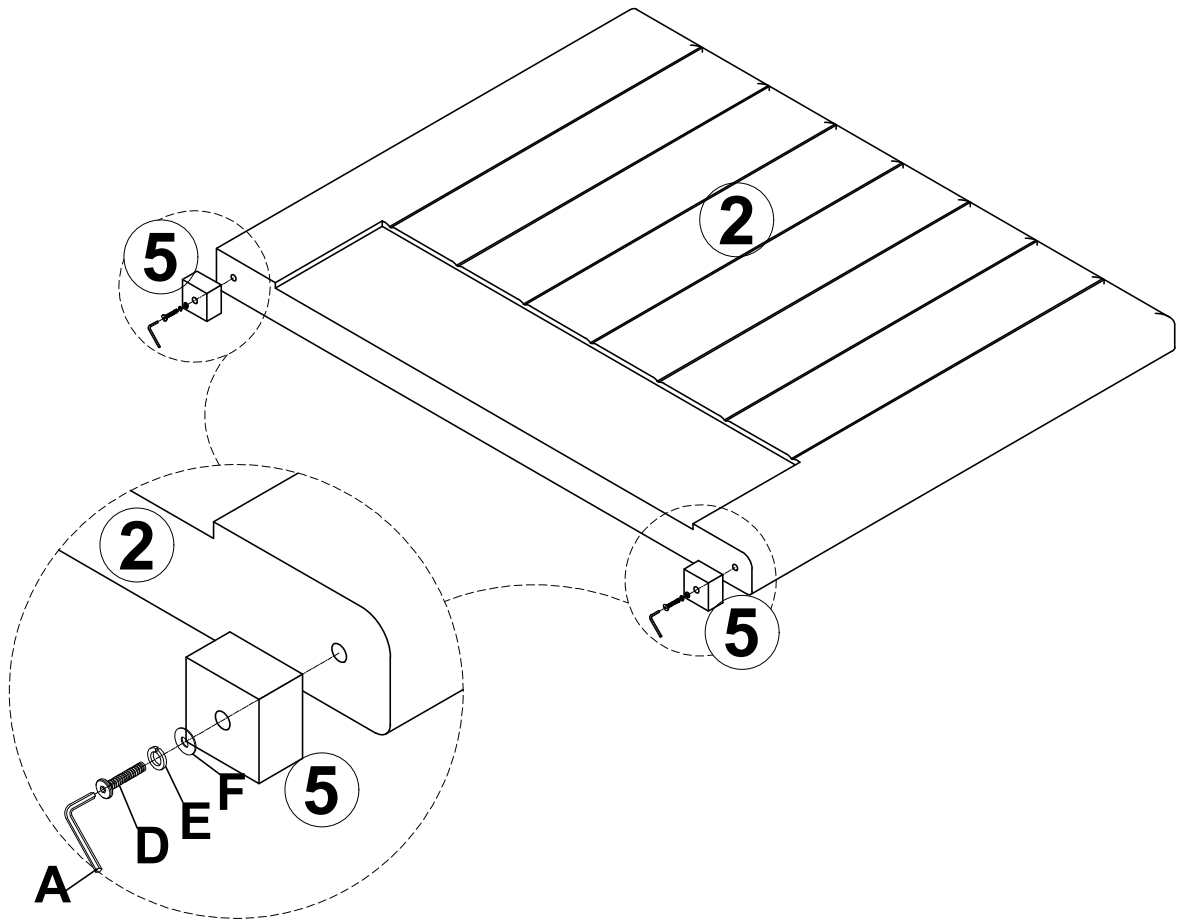
|  |  |  |
|--|--|--|
| <b>F</b><br> | <b>E</b><br> | <b>D</b><br> |
| <b>2PCS</b>  | <b>2PCS</b>  | <b>2PCS</b>  |



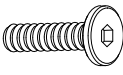

# STEP 4

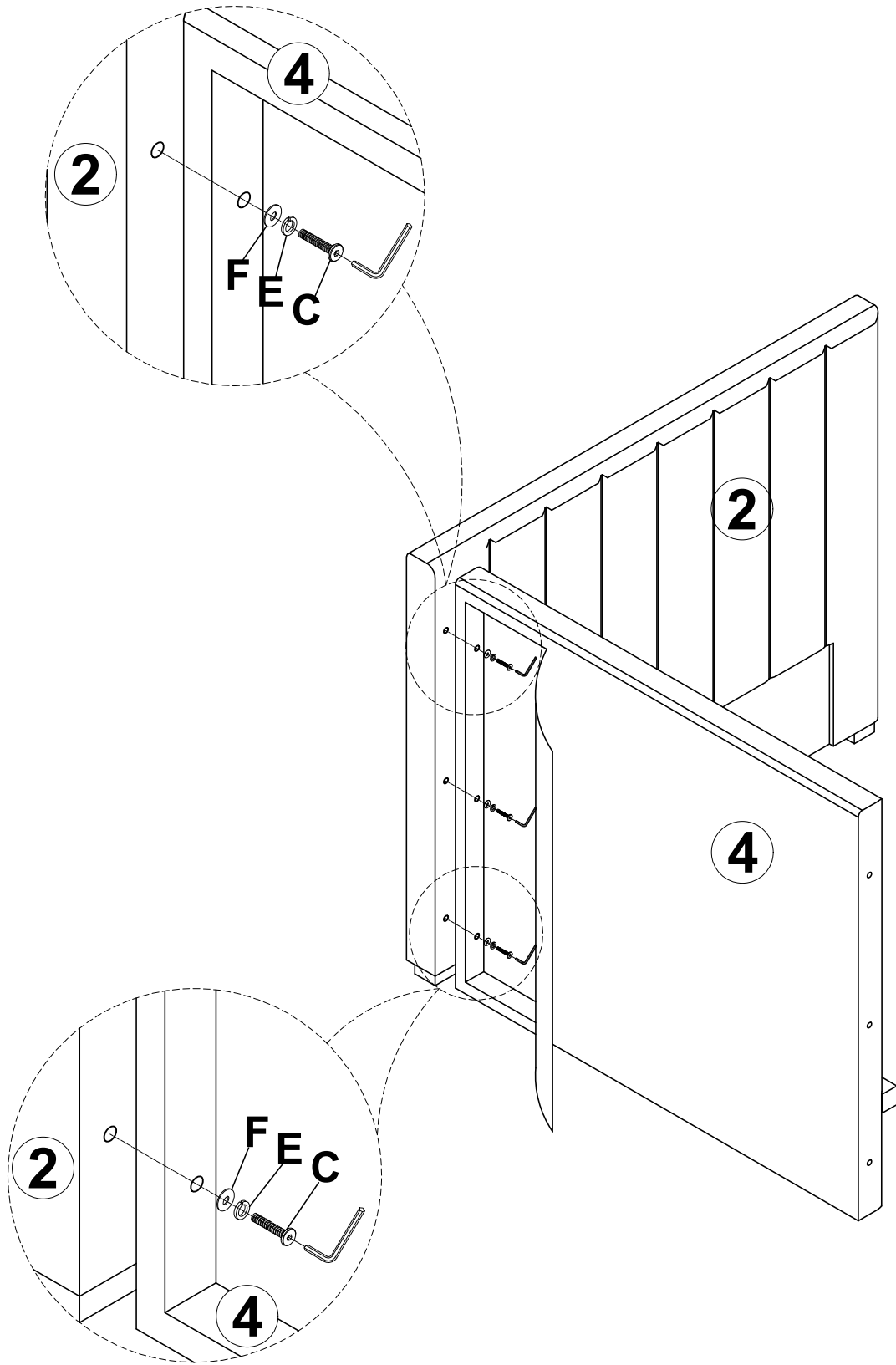
|             |  |             |  |             |  |
|-------------|--|-------------|--|-------------|--|
| <b>F</b>    |  | <b>E</b>    |  | <b>C</b>    |  |
| <b>3PCS</b> |  | <b>3PCS</b> |  | <b>3PCS</b> |  |



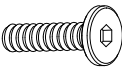

# STEP 5

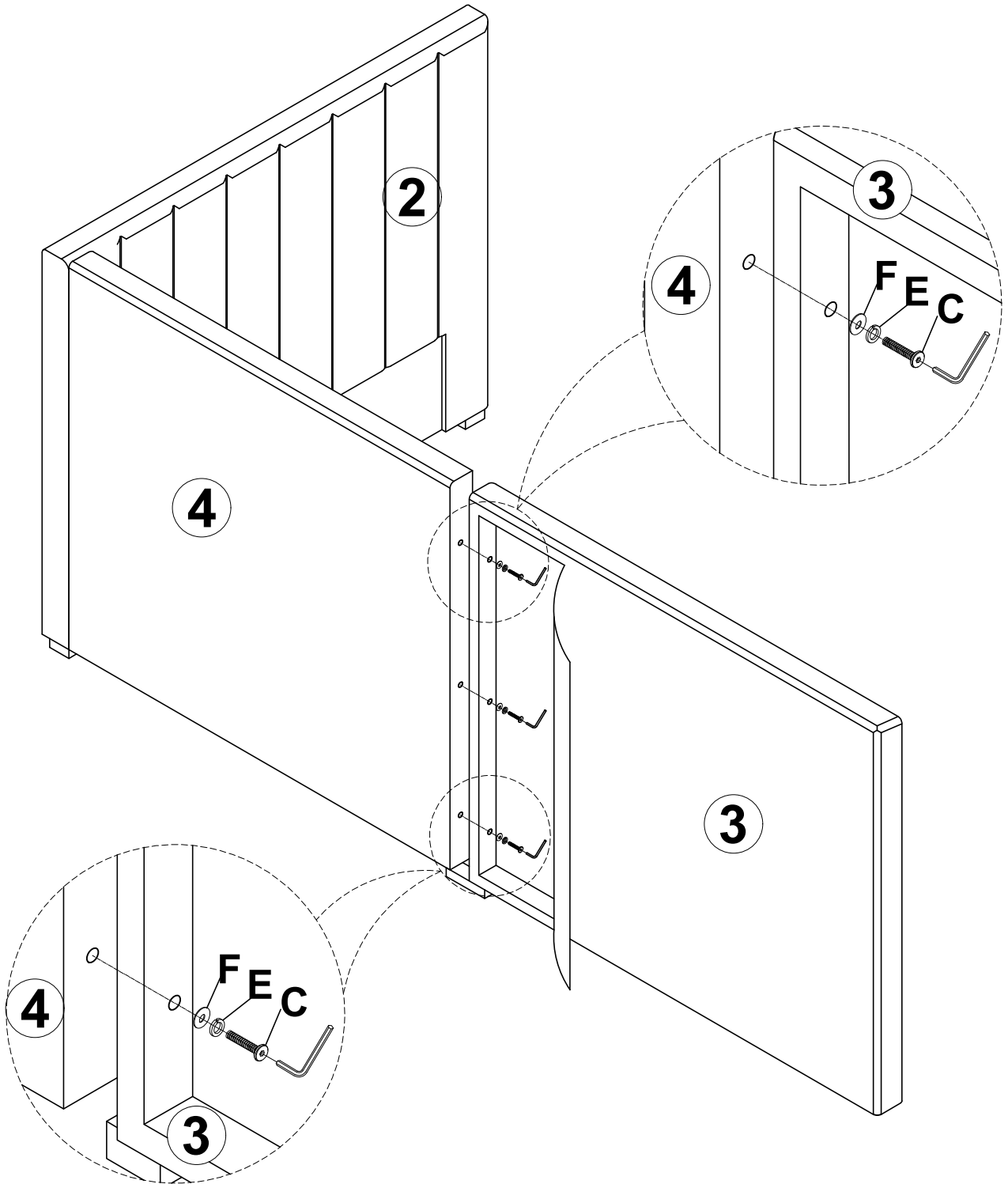
|  |  |  |
|--|--|--|
| <b>F</b><br> | <b>E</b><br> | <b>C</b><br> |
| <b>3PCS</b>  | <b>3PCS</b>  | <b>3PCS</b>  |



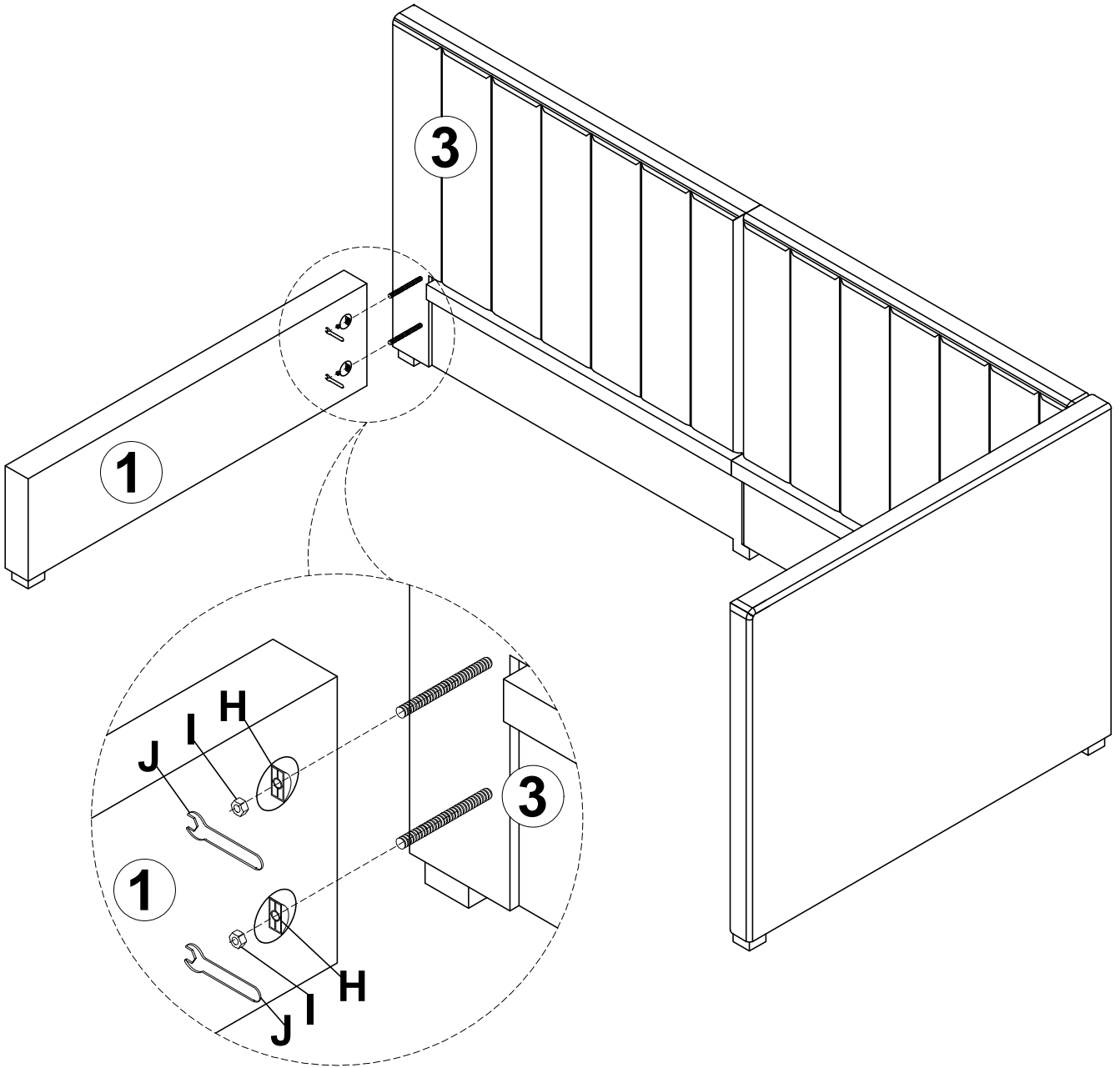

# STEP 6

|            |   |             |  |             |  |
|------------|---|-------------|--|-------------|--|
| <b>J</b>   |  | <b>I</b>    |  | <b>H</b>    |  |
| <b>1PC</b> |   | <b>2PCS</b> |  | <b>2PCS</b> |  |



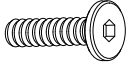

# STEP 7

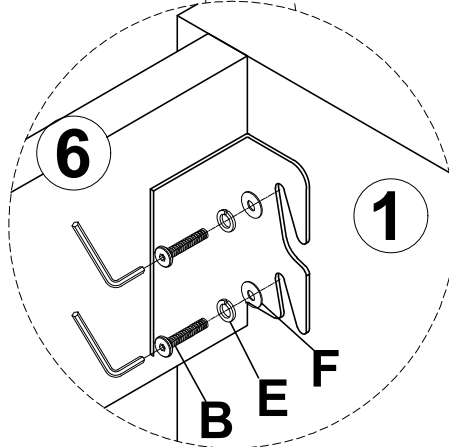
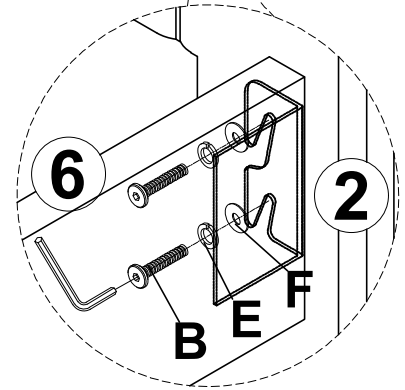
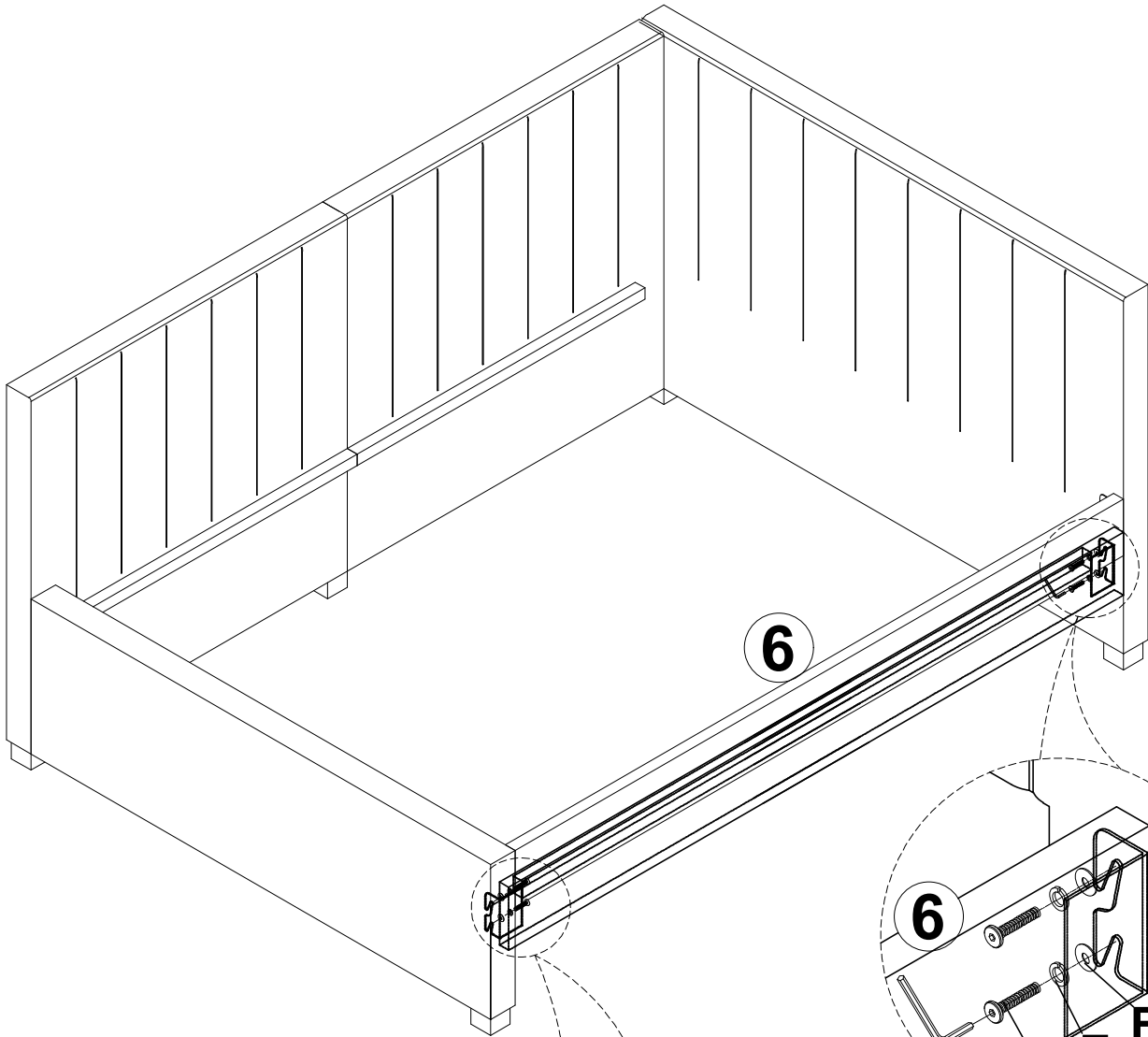
|  |  |  |
|--|--|--|
| <b>F</b><br> | <b>E</b><br> | <b>B</b><br> |
| <b>4PCS</b>  | <b>4PCS</b>  | <b>4PCS</b>  |

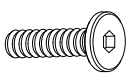

# STEP 8

|  |  |  |
|--|--|--|
| <b>N</b><br> | <b>M</b><br> | <b>K</b><br> |
| <b>4PCS</b>  | <b>4PCS</b>  | <b>4PCS</b>  |

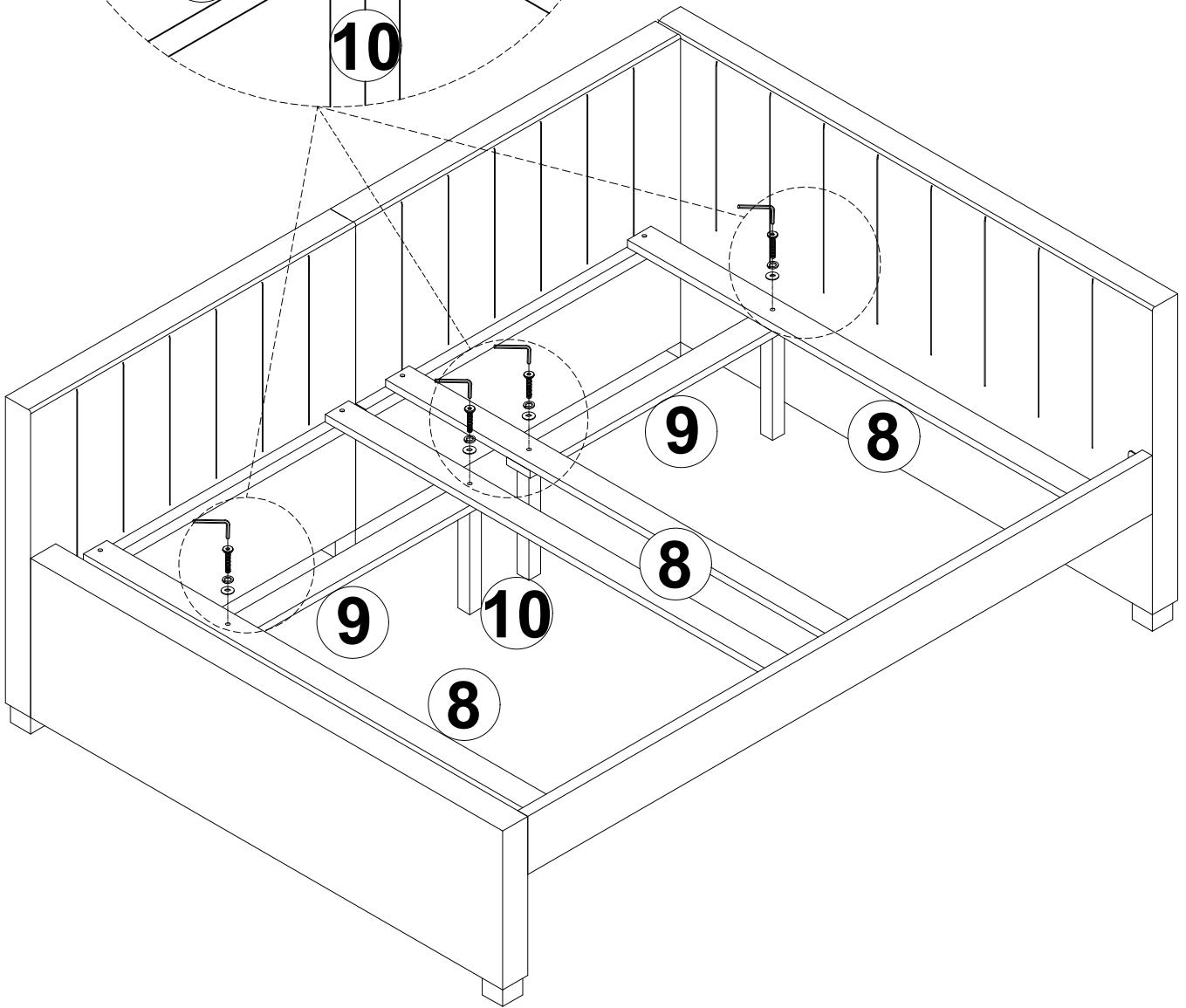
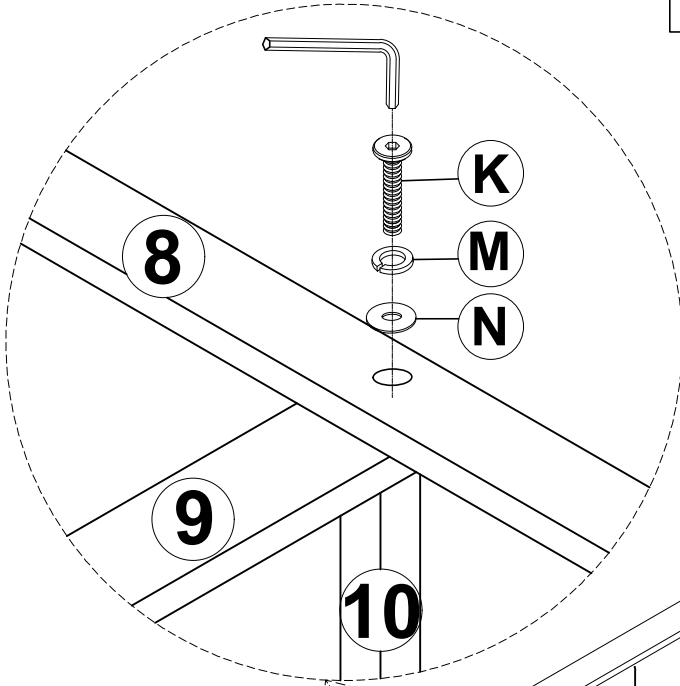

**STEP 9**



**20PCS**

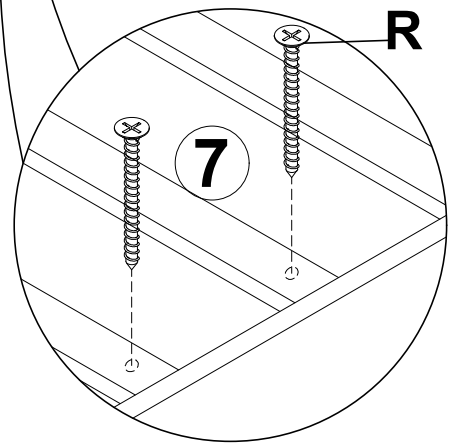
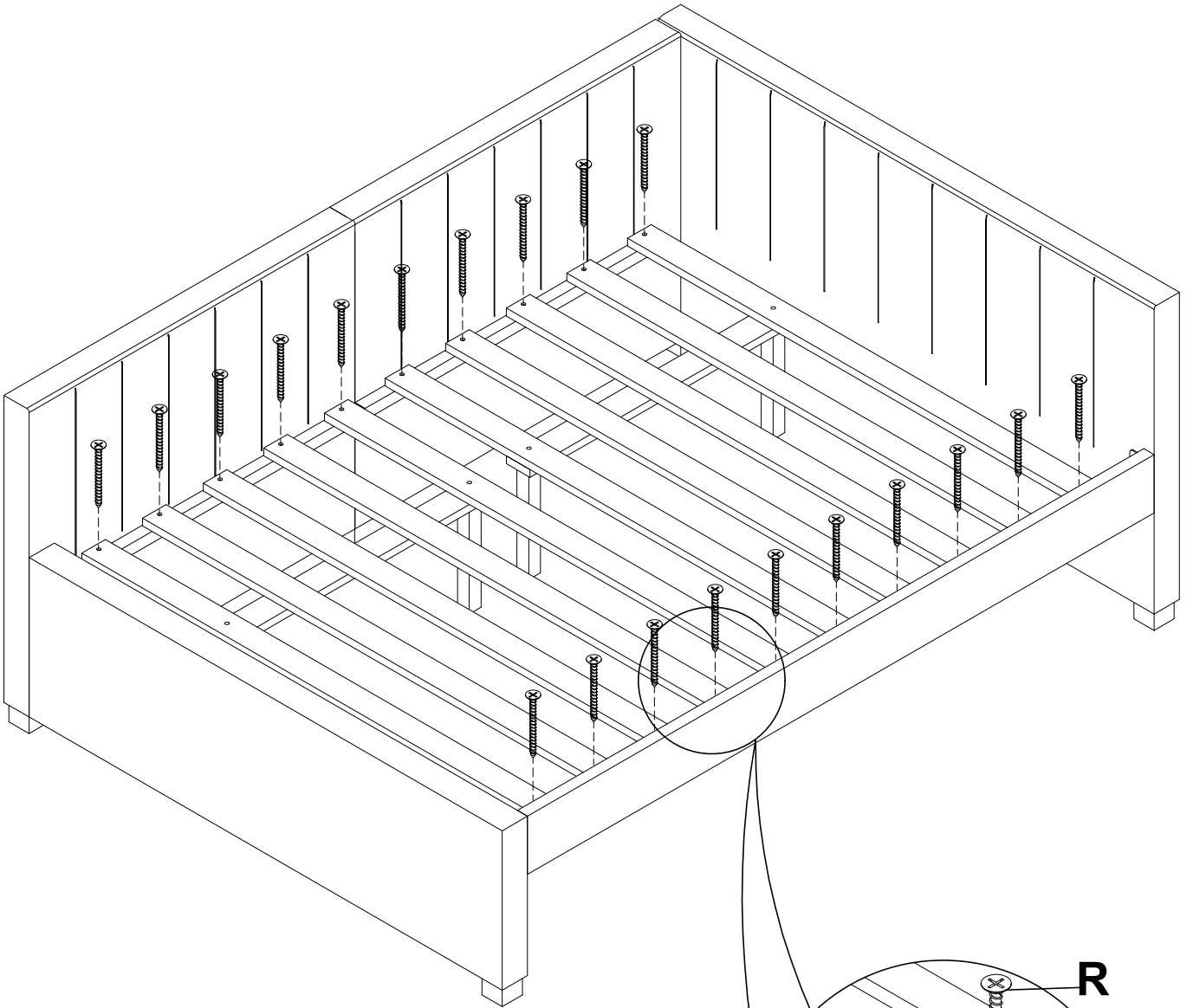

**STEP 10**

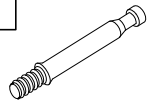
|             |  |
|-------------|--|
| <b>S</b>    |  |
| <b>8PCS</b> |  |

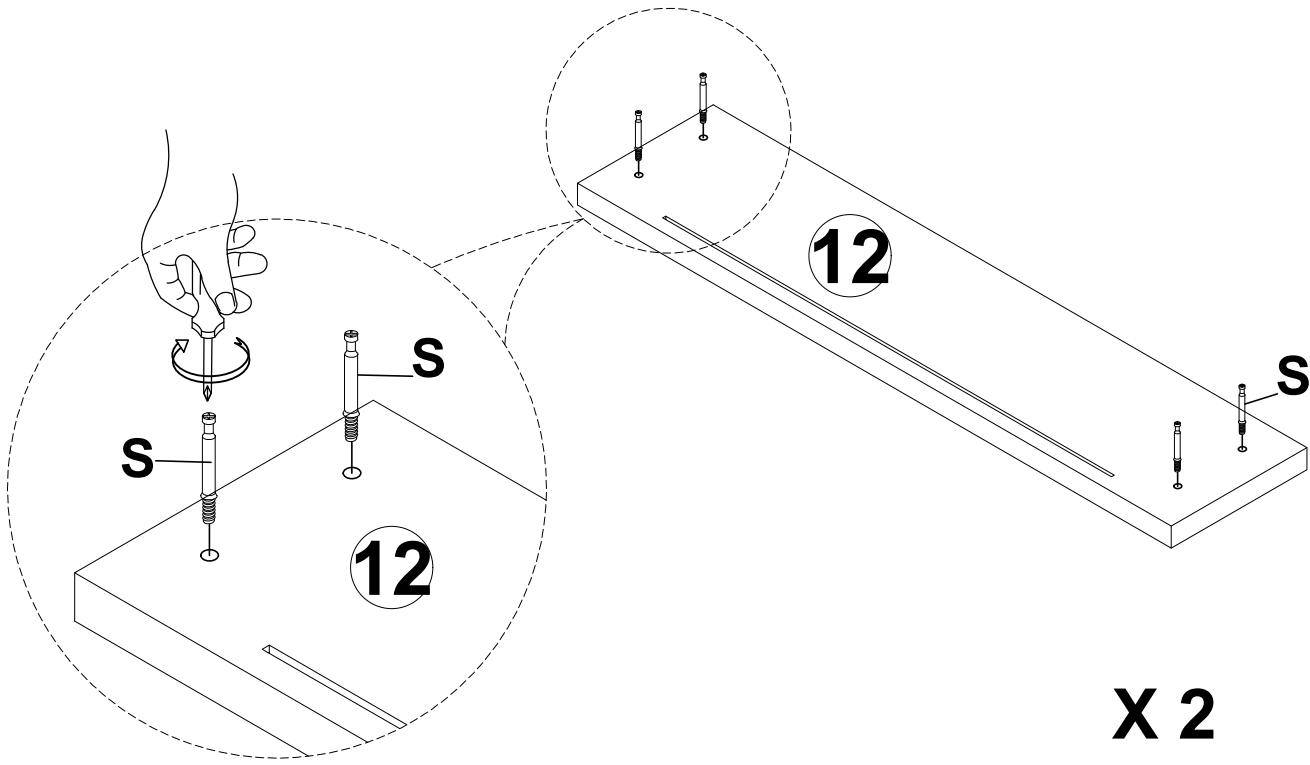

**STEP 11**

|             |   |
|-------------|---|
| <b>T</b>    |  |
| <b>8PCS</b> |   |

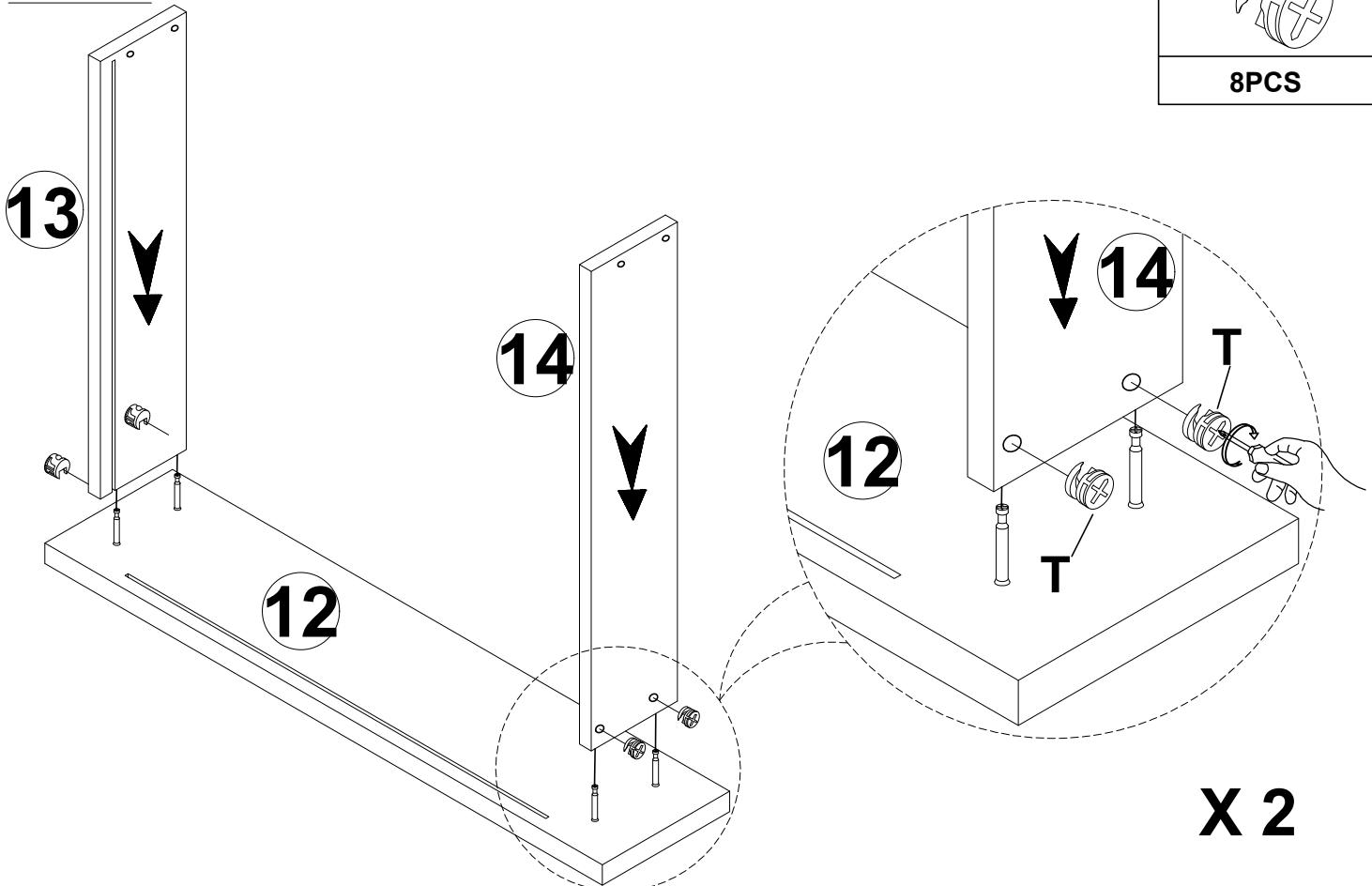

**STEP 11**

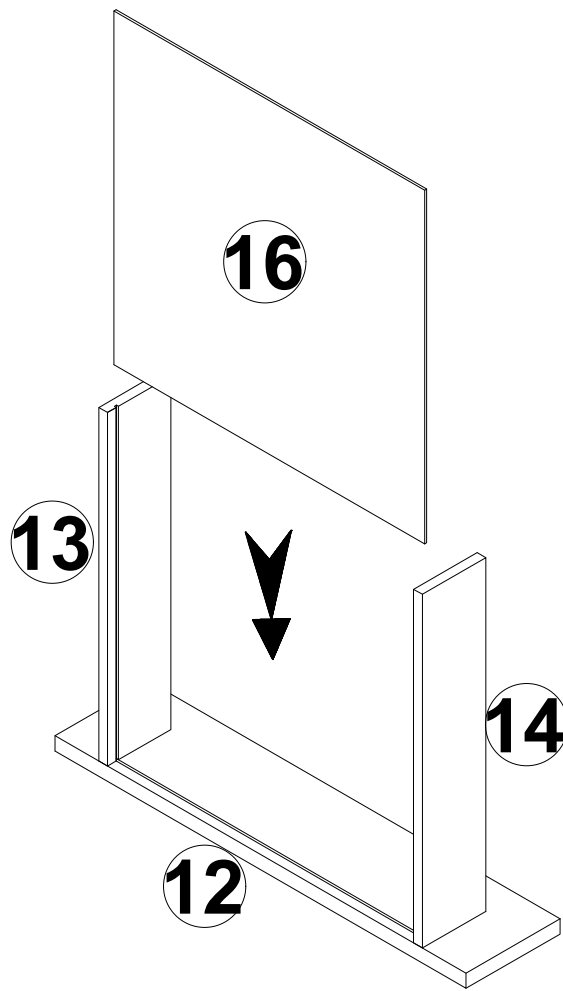

**X 2**

**STEP 13**

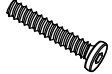
|   |   |
|---|---|
| Q   | L   |
|  |  |
| 8PCS  | 8PCS  |

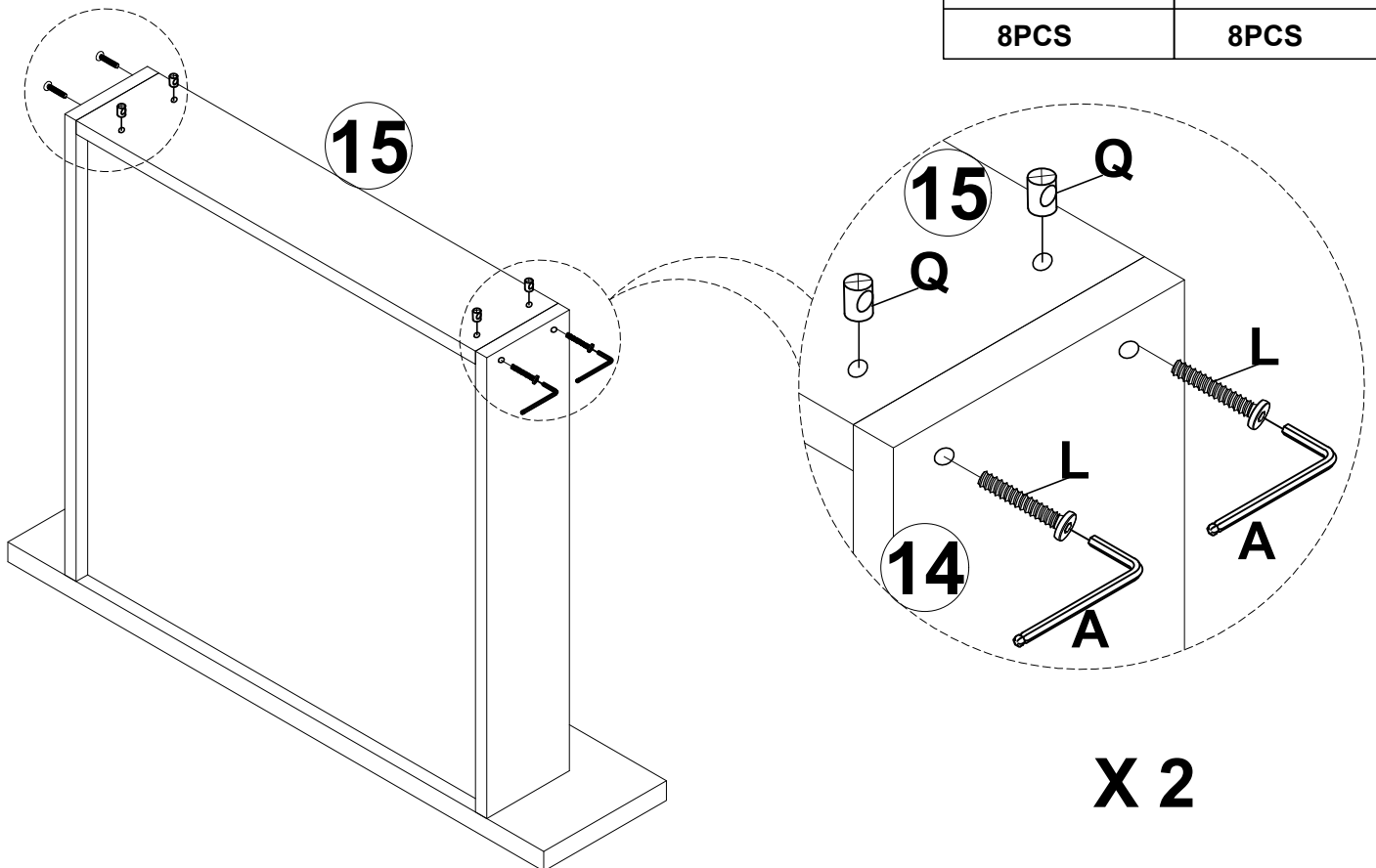

**X 2**

**STEP 12**

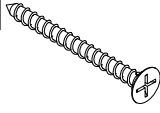
|       |  |
|-------|--|
| R     |  |
| 16PCS |  |

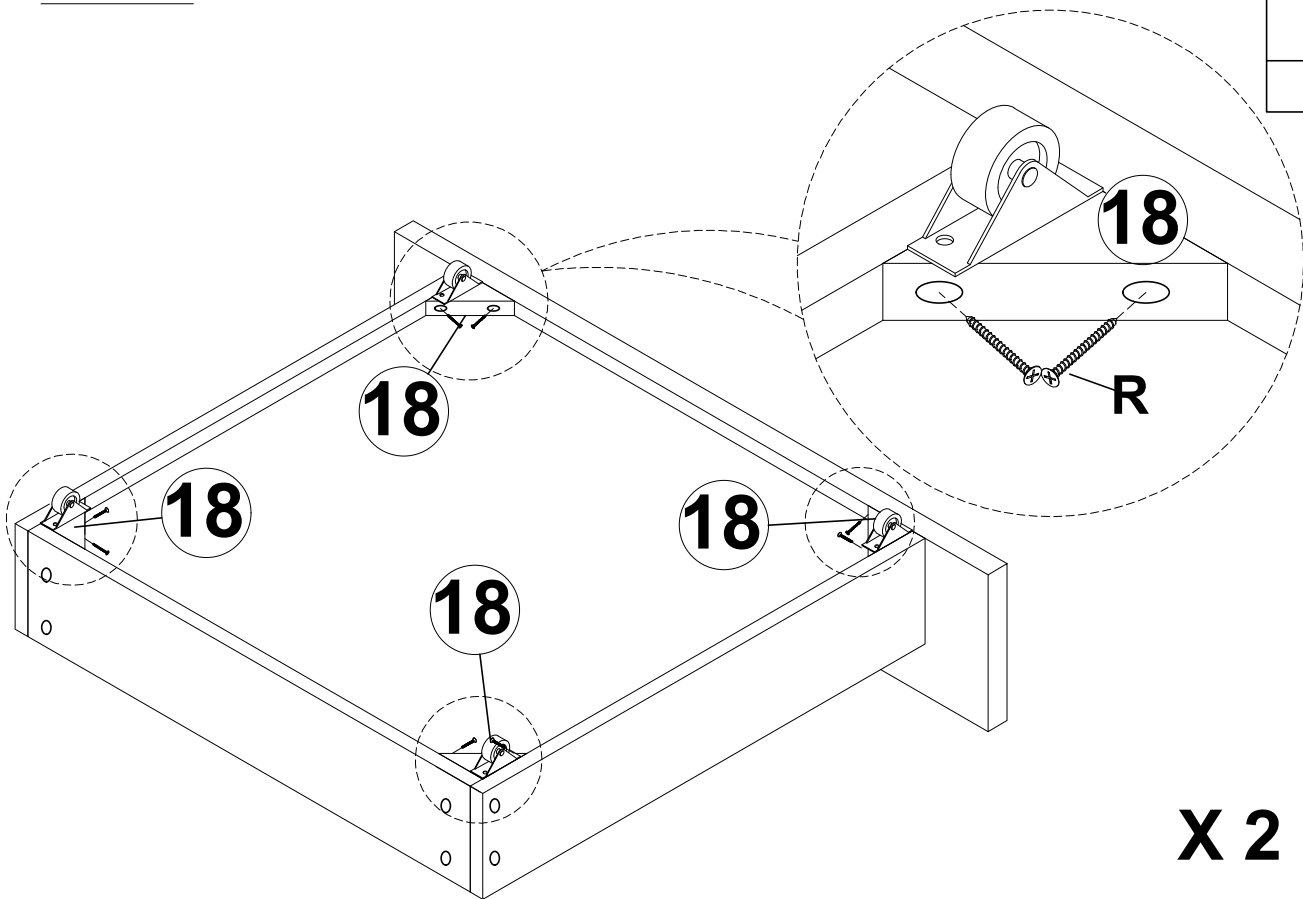

**X 2**

**STEP 15**

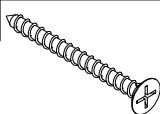
|      |   |
|------|---|
| R    |  |
| 8PCS |   |

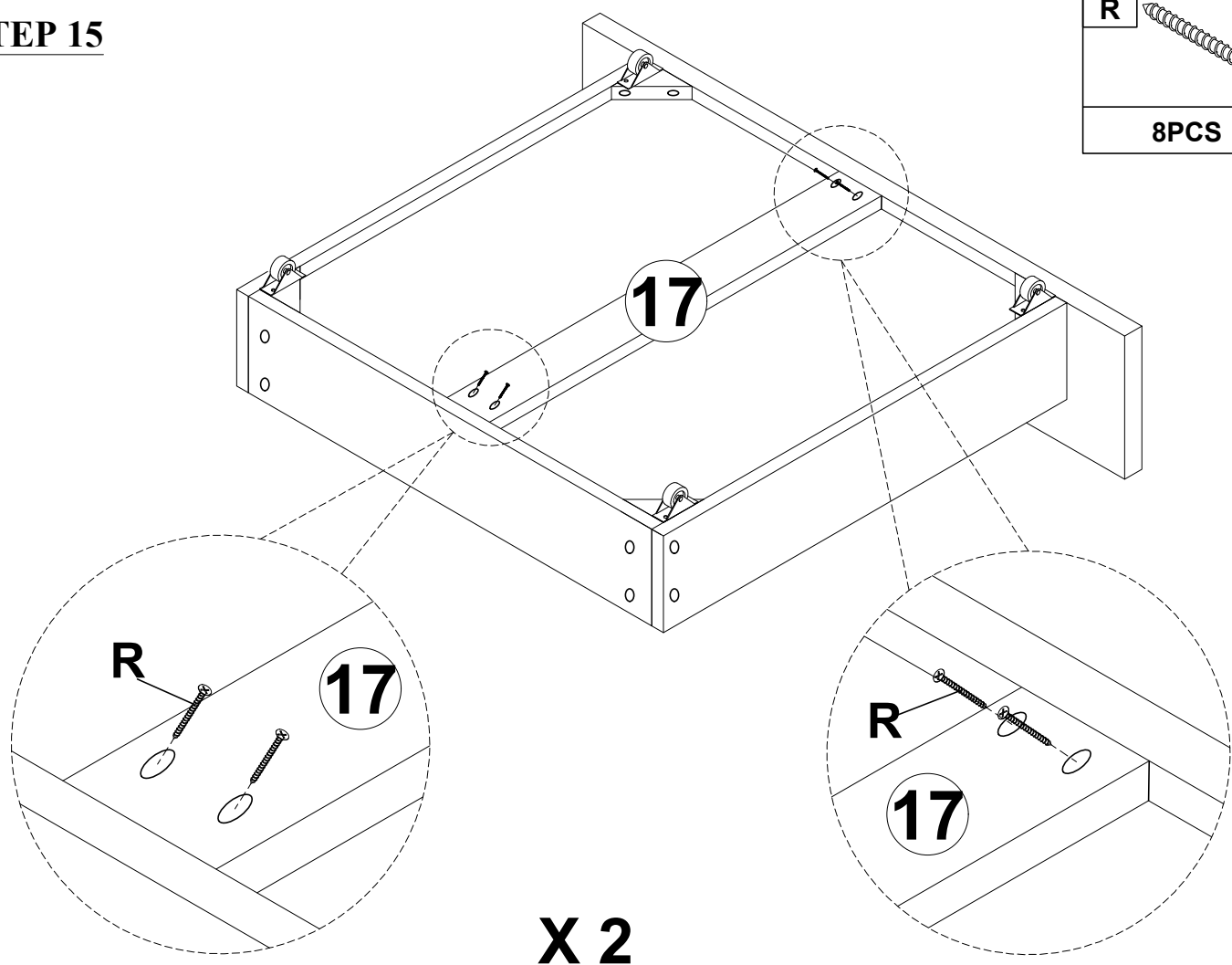

**X 2**

**STEP 13**

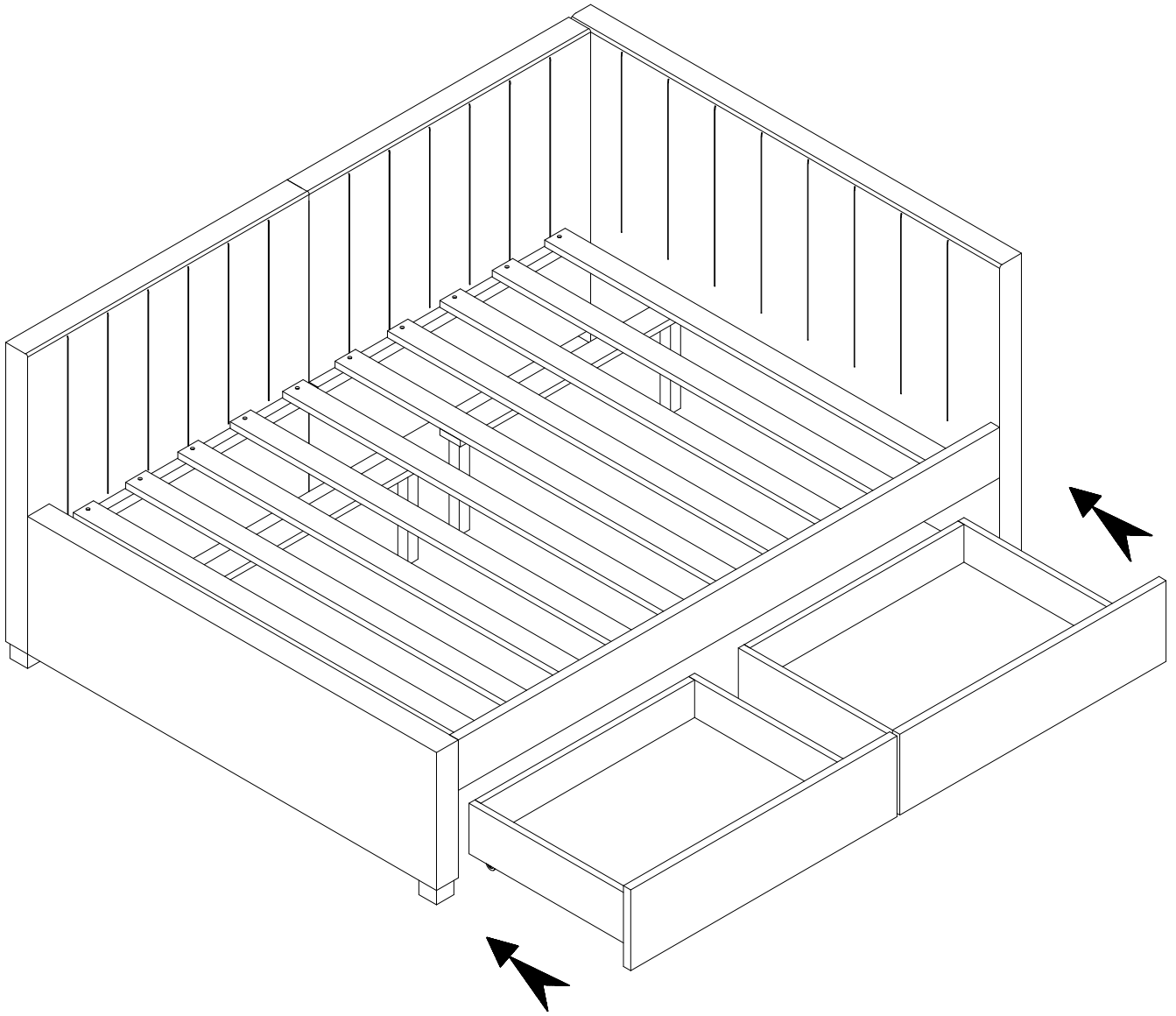

**STEP 14**

