





















	①*2		③*1		⑦*1		A*2		B*2		C*4
Left 	②*2		④*3		⑧*1		D*1		E*4		F*2
			⑤*1		⑨*2		G*2		H*2		I*4
			⑥*1 (small)		⑩*4		J*22		K*30		L*4
			⑥*4 (big)								

The card slots on the left side and the right side panel are different, so please use the card slots to distinguish between them.

⑩

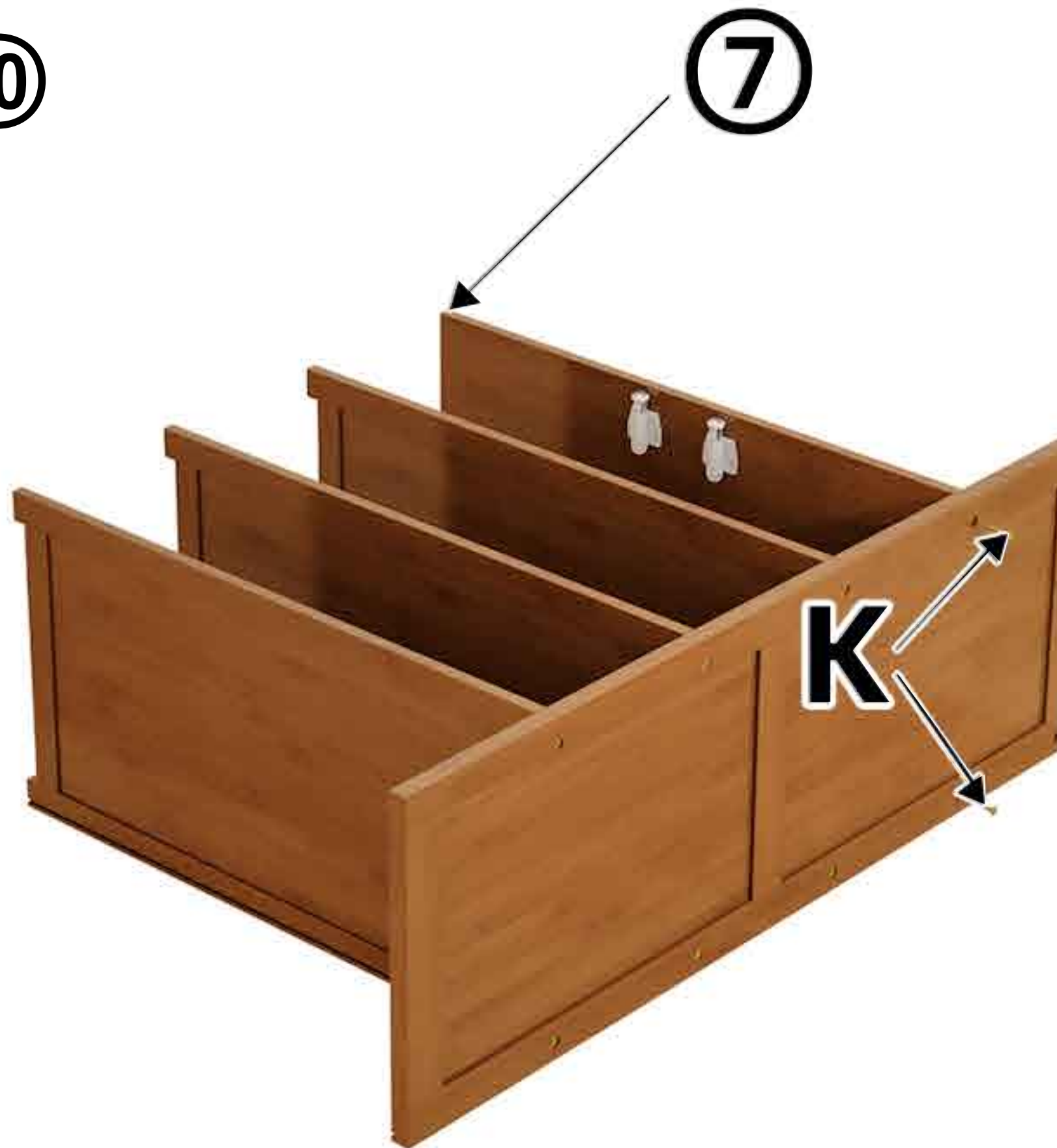

Mounting the ⑦ number plate with the iron absorber underneath

⑪

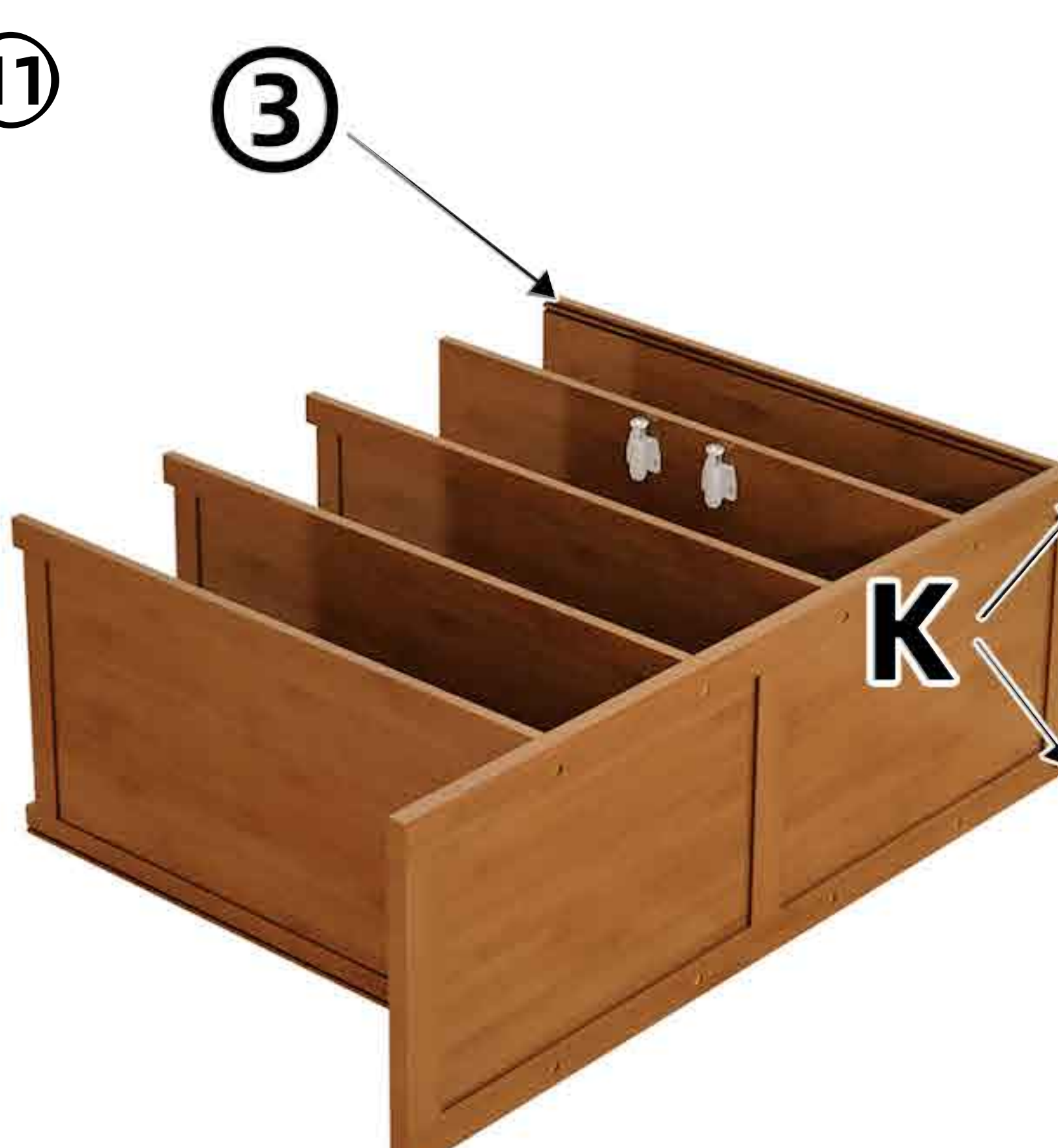

⑫



①

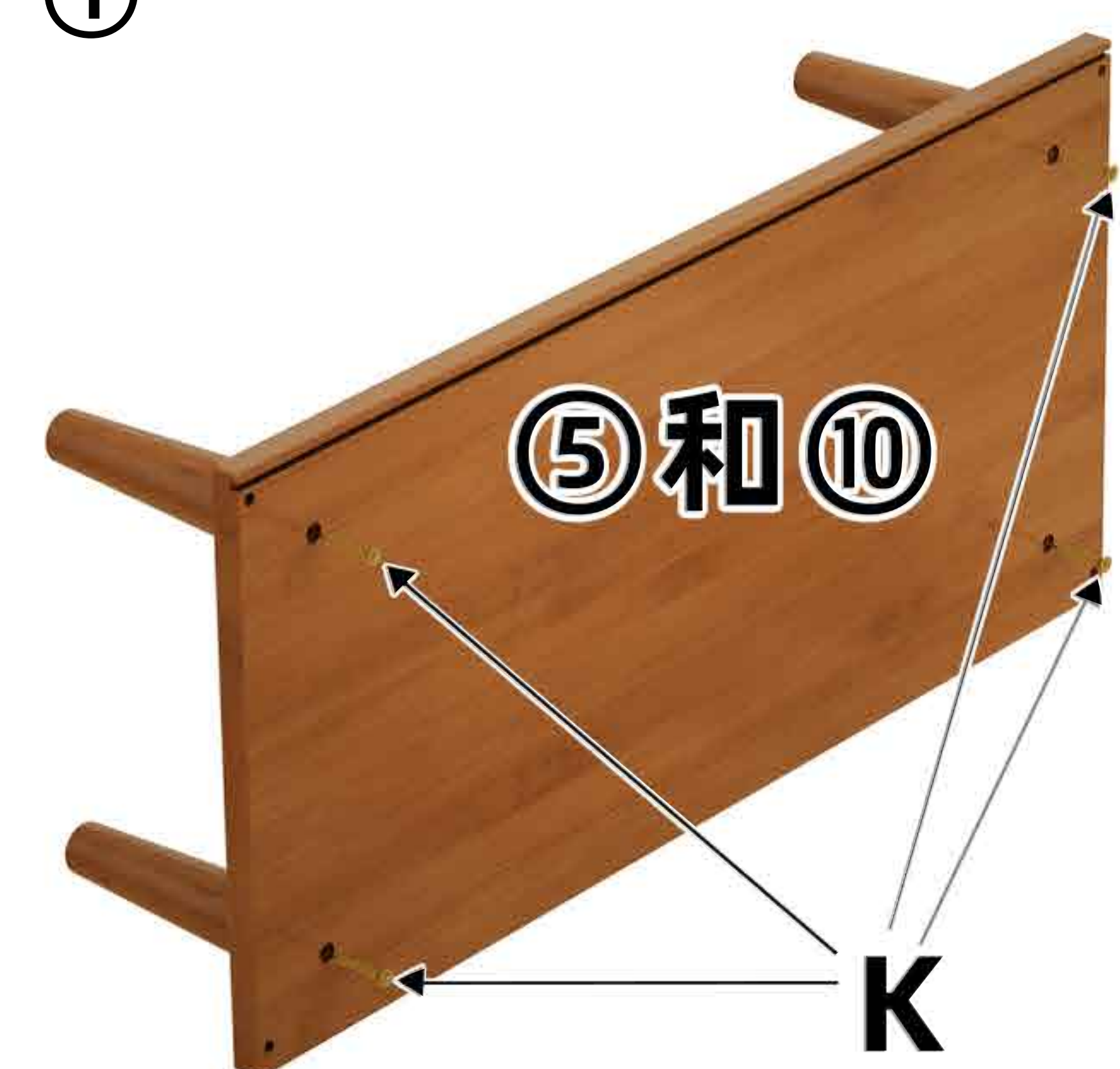

⑤和⑩

K

②



⑦

F和I

③

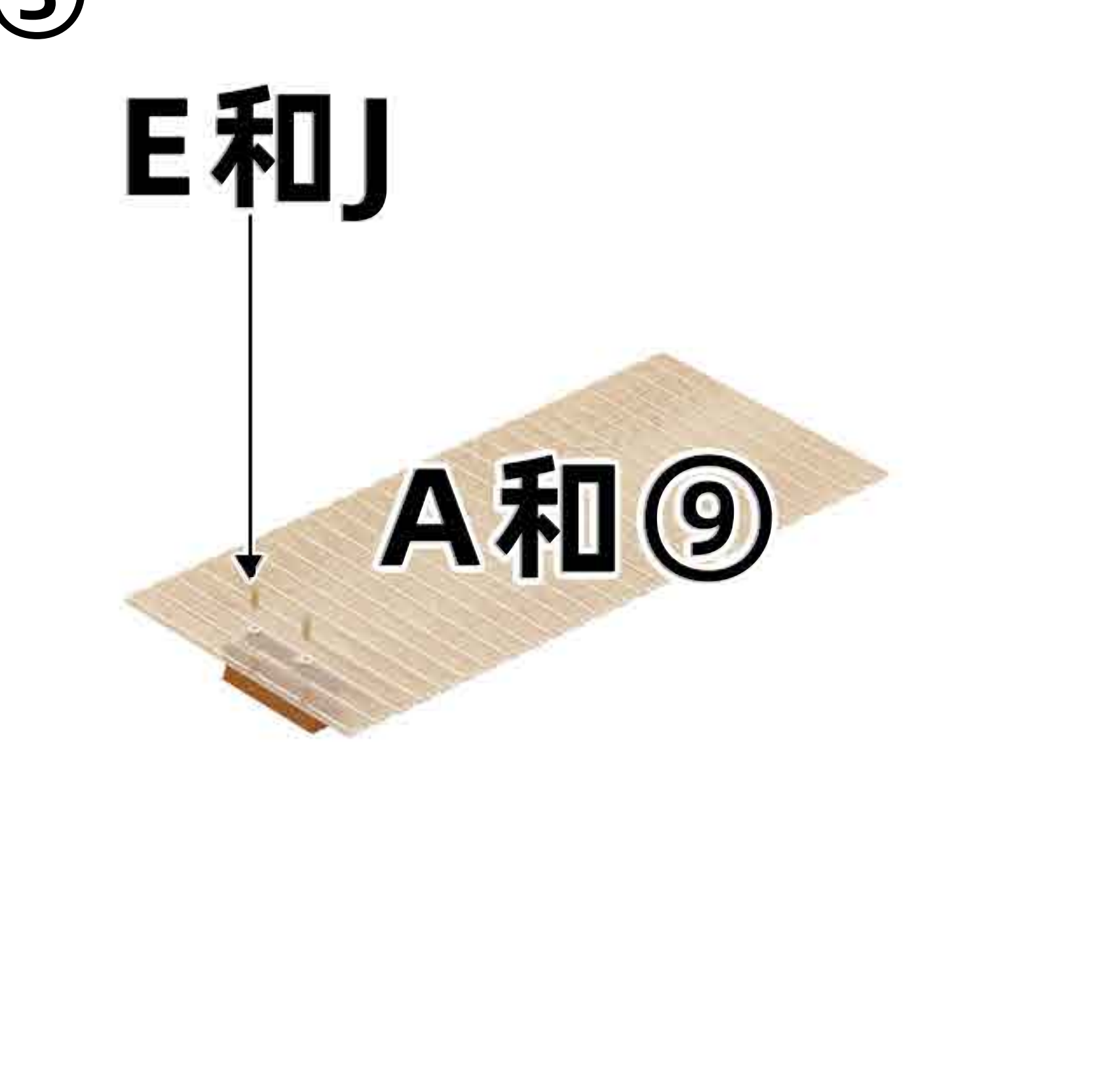

E和J

A和⑨

⑬

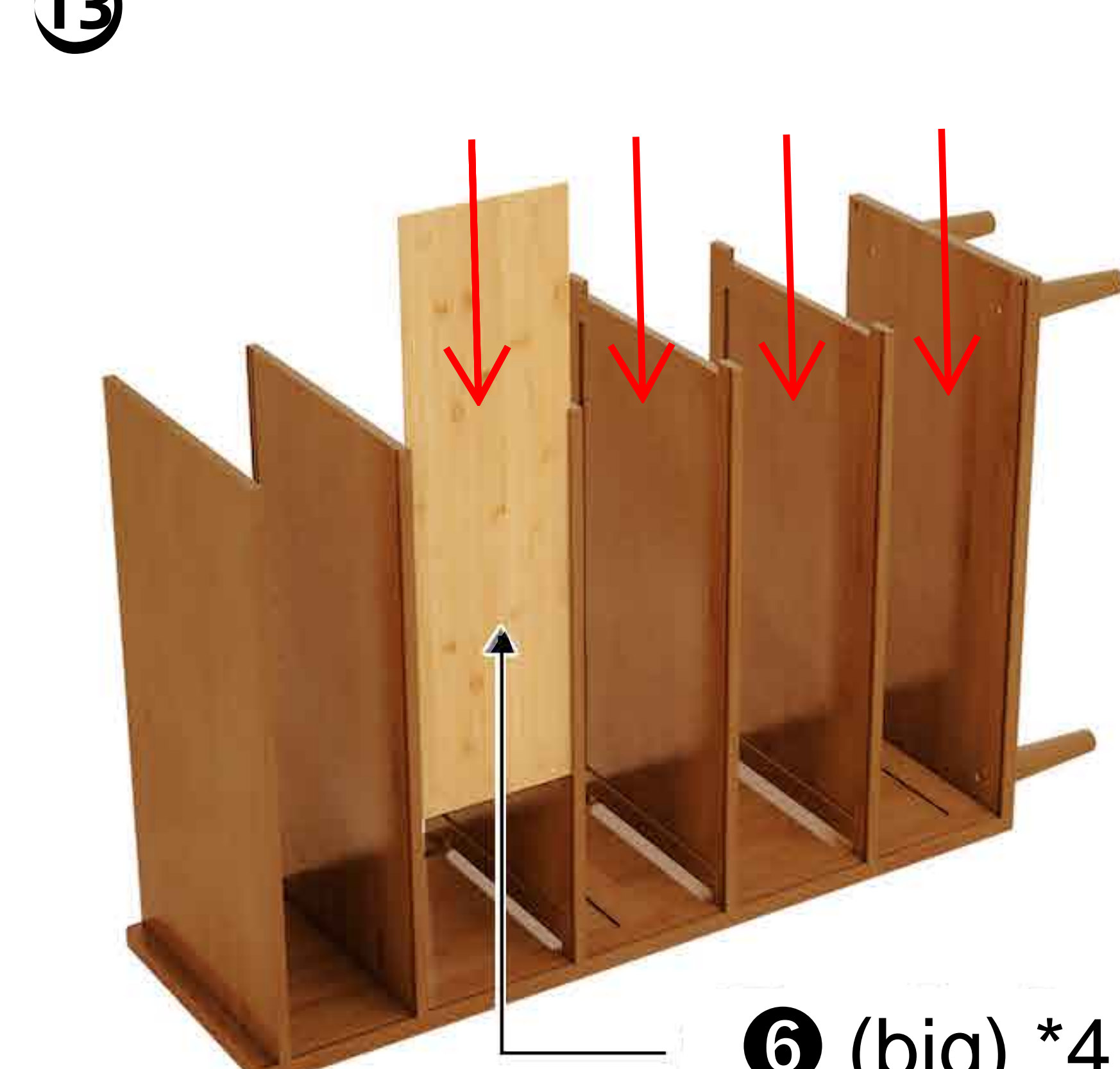

⑥ (big) *4

Insert ⑥ (big) into the specified position

⑭

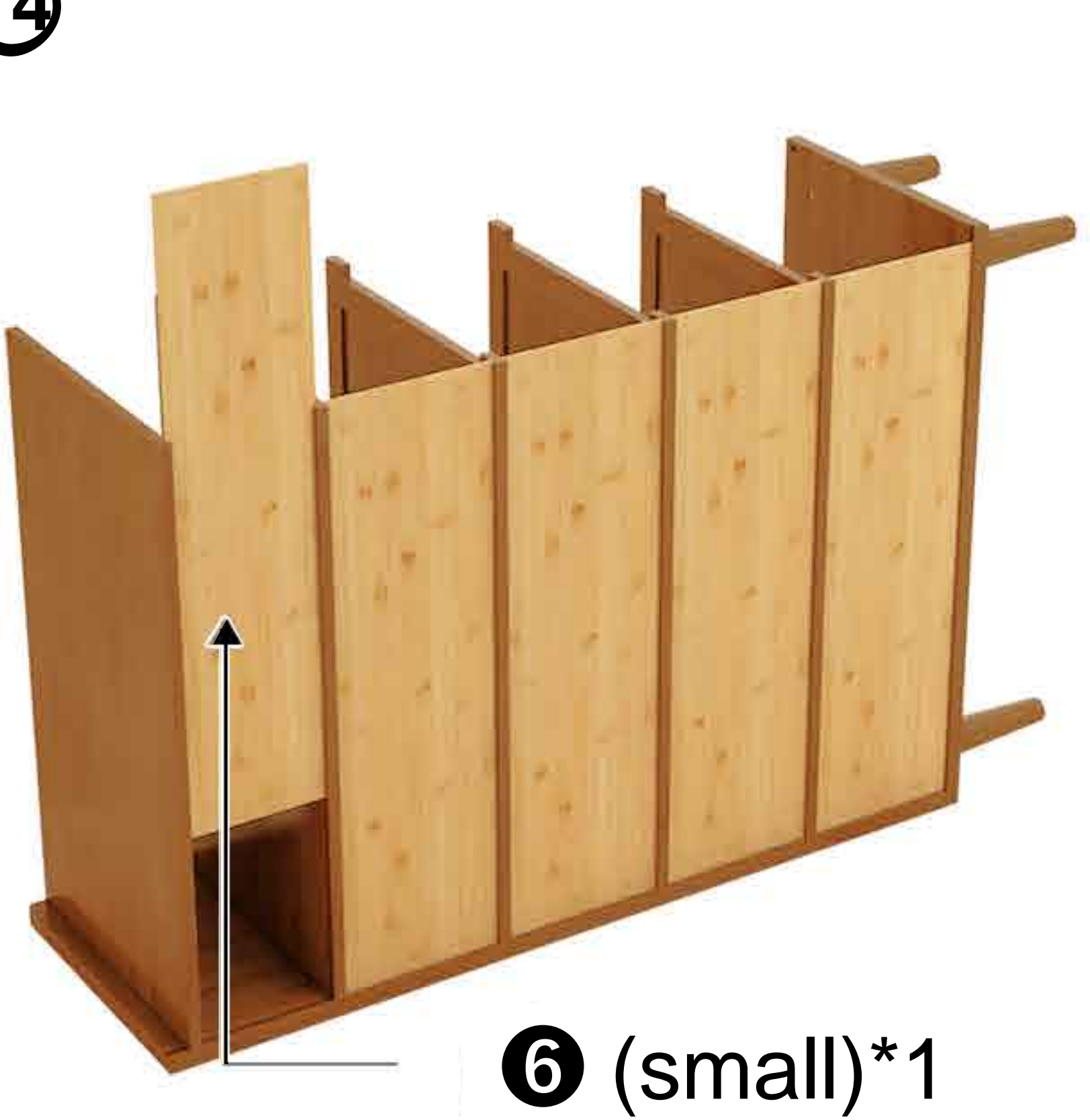

⑥ (small) *1

Insert ⑥ (small) into the specified position

⑮

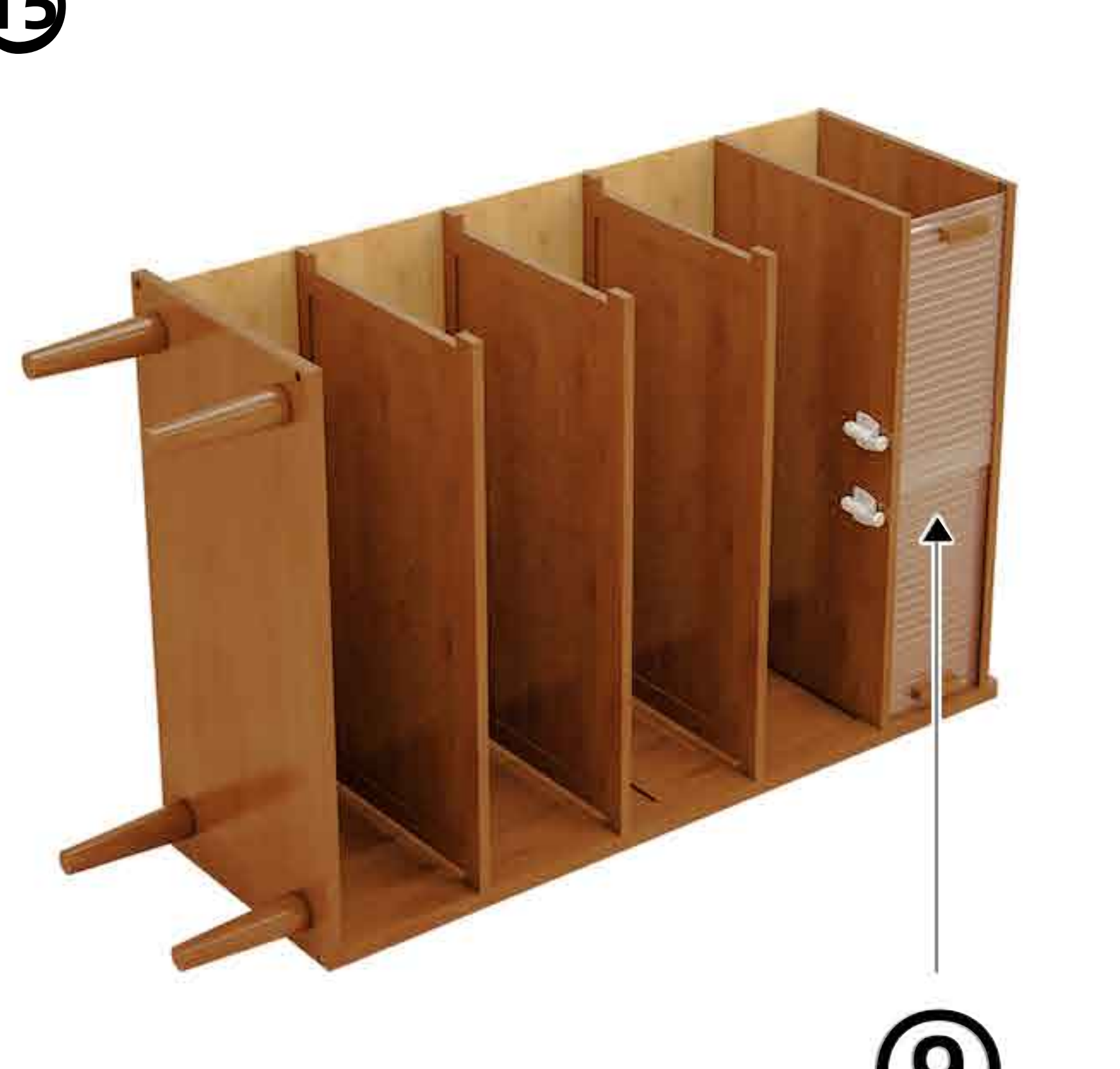

⑨

Put in ⑨, please pay attention to the direction of the puller

④



①

J和G

⑤



①和C

J

Install the ④ hinge on the ① door with the hinge protruding side facing outward

⑥

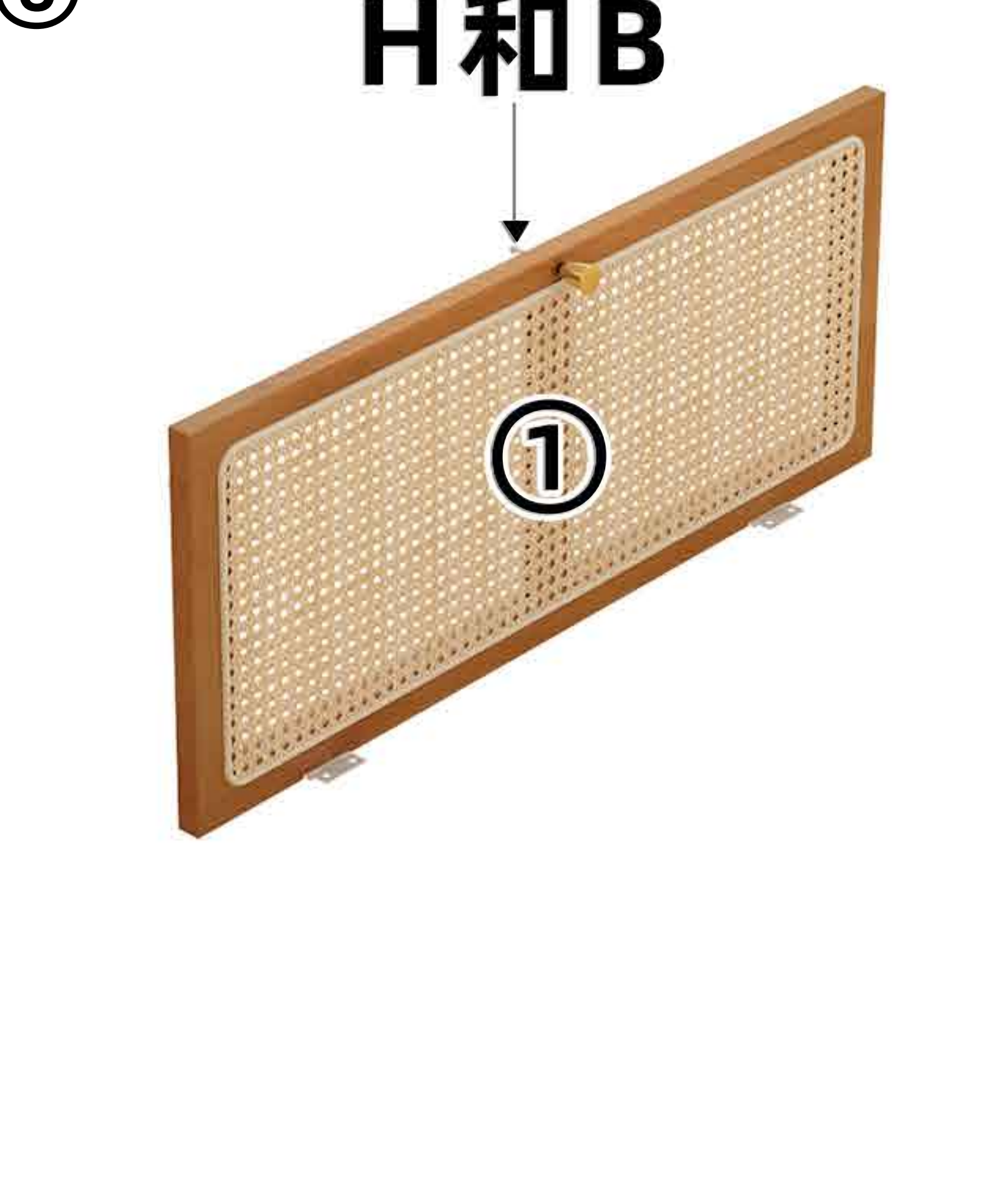

H和B

①

⑯



② (左) 和K

⑰



K

⑱

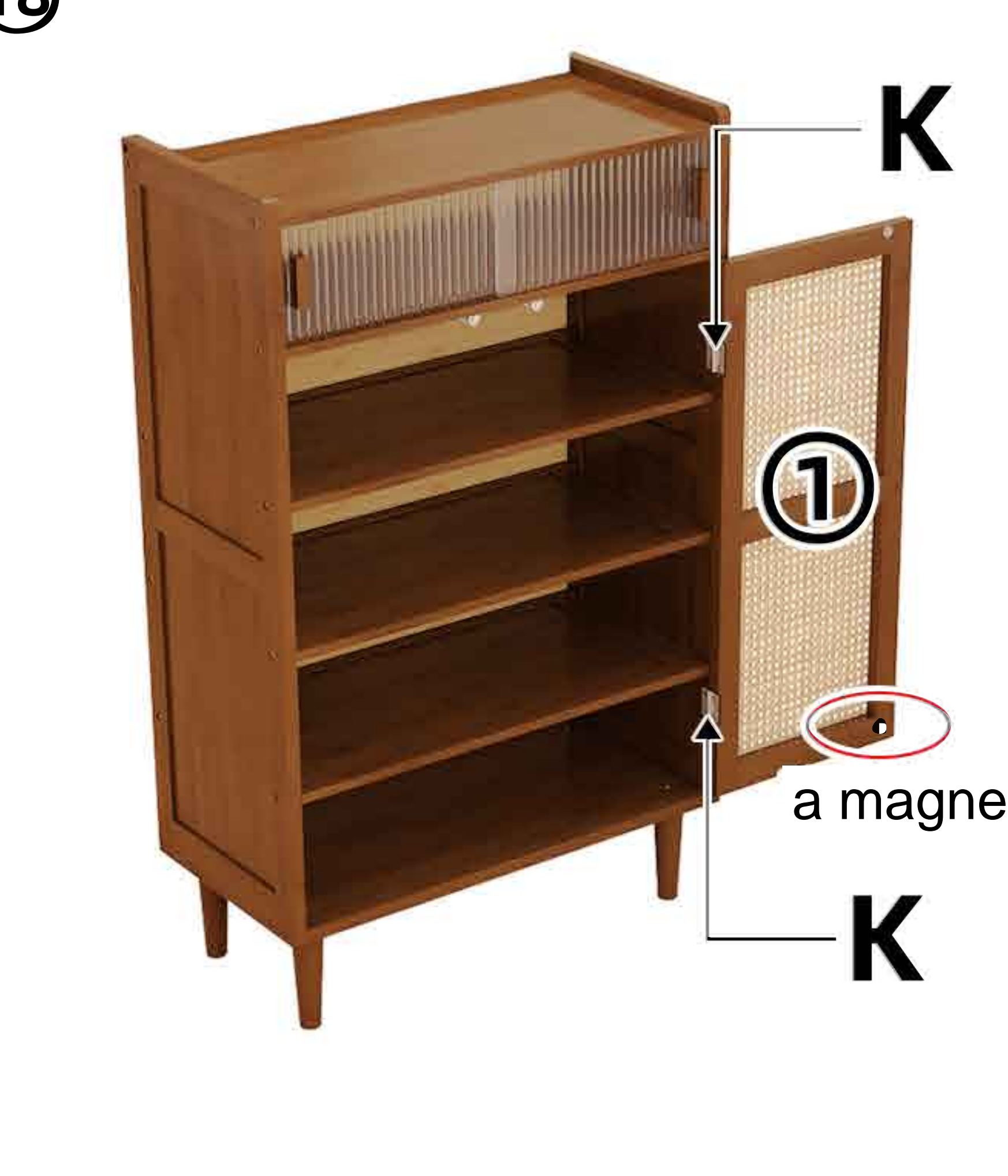

①

a magnet

K

⑦

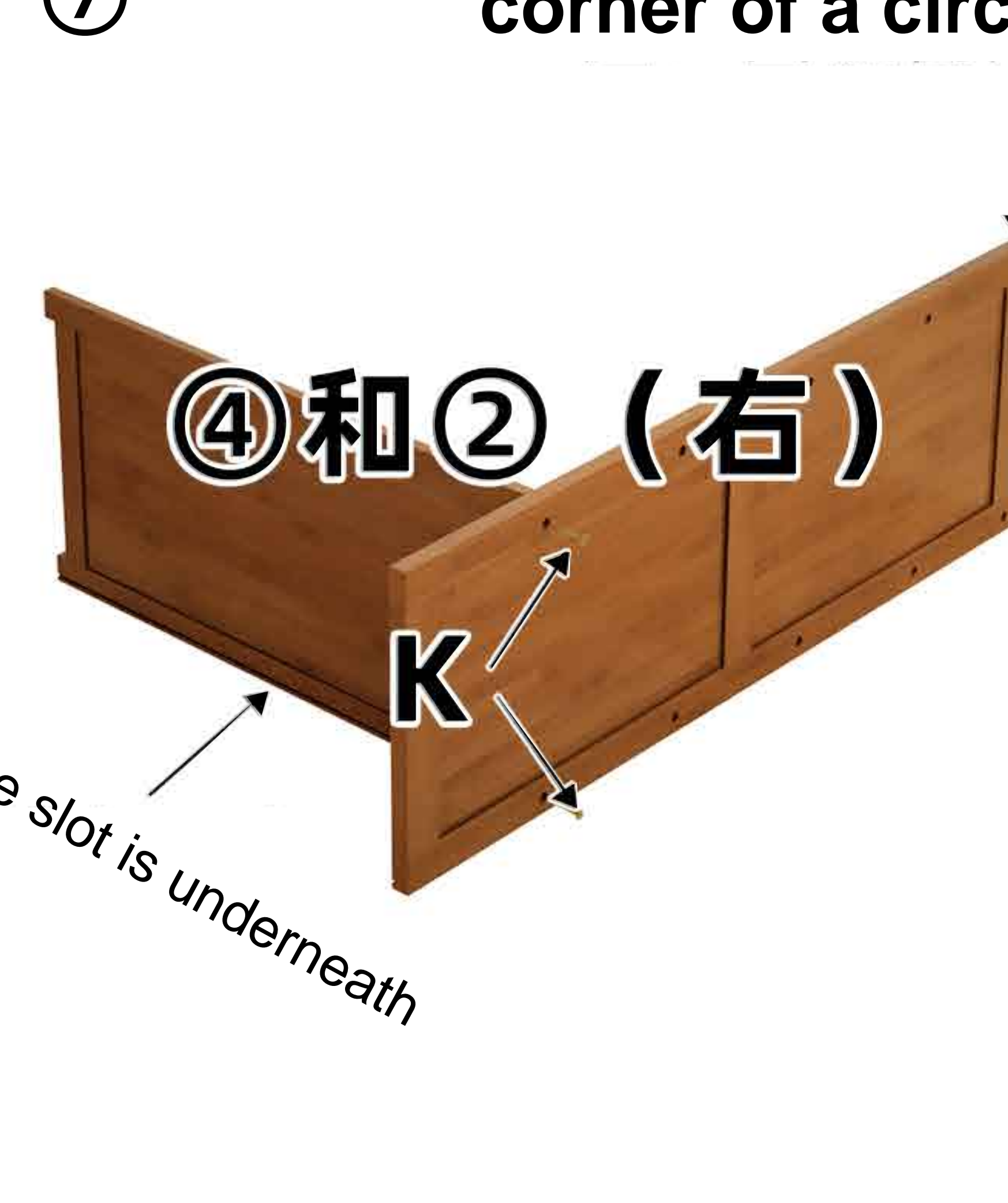

④和② (右)

K

The slot is underneath

⑧



④

K

⑨



④

K

⑲



D和L

⑳



①

K

㉑



⑧

K