



Outdoor  
Living Today

# ASSEMBLY MANUAL

## 8x4 Spacesaver & 8x4 Gardensaver With Single Doors

Stock Code:  
84-S-BASE-BEV  
Version #1.4  
July 21, 2025



**Optional door  
configuration**



## CONTACT

### ADDRESS

9393 287th Street,  
Maple Ridge, British Columbia,  
Canada V2W 1L1

### PHONE & FAX

Toll Free: 1-888-658-1658  
Fax:

### ONLINE

Email: [olmsupport@outdoorlivingtoday.com](mailto:olmsupport@outdoorlivingtoday.com)  
Web: [www.outdoorlivingtoday.com](http://www.outdoorlivingtoday.com)

# What You Need to Know

Thank you for purchasing a 8x4 Spacesaver / Gardensaver.

*Please take the time to identify all the parts prior to assembly.*

## IMPORTANT INFORMATION

It is the sole responsibility of the customer to check with your local municipal or county by-laws before ordering this product to confirm it complies with building codes in your area.

If the product is elevated, any structural and building code requirements are solely the customer's responsibility, and should be abided by.

Snow load ratings vary by geographical location. If heavy or wet snowfall occurs, it is advisable to sweep snow off roof frequently. In areas with high or gusty wind conditions, it is advisable to install the structure securely to the ground.

Have a regular maintenance plan to ensure screws, doors, windows and parts are tightly affixed.

All structures purchased from Outdoor Living Today are covered for a period of one year for defects in manufacturing and workmanship. Costs incurred for customer installations are not included.

*Failure to use supplied parts included in this kit could result in poor product performance and may void your warranty. Please contact Outdoor Living Today's Customer Toll Free Line if you plan to deviate from our written instructions.*

## Warranty

In the event of a missing or broken piece, please contact Outdoor Living Today Customer Support at [olmsupport@outdoorlivingtoday.com](mailto:olmsupport@outdoorlivingtoday.com) within 30 days of the delivery of your purchase. It is our commitment to you to courier replacement parts, free of charge, within 10 business days of this notification. Replacement parts will not be provided free of charge after the 30 day grace period.

Customer agrees to hold Outdoor Living Today and any Authorized Dealers free of any liability for improper installation, maintenance and repair.

# What to do Before my Shed Arrives?



Become familiar with this assembly manual and determine if you can complete the project yourself or will require a professional contractor.



One helper is recommended to assist in constructing your shed. It generally takes two people two days to assemble a shed. If you're hiring a contractor, their rate should be in line with that duration of work.



Clear the construction area and ensure a clear pathway for delivery when the freight company arrives. Remove all debris: roots, grass, rocks, etc.



Excavate the site. Contact your local utilities company to ensure there are no gas or electric lines buried in the area before digging.



Decide on the type of foundation you will be using: Concrete slab, or 4-6 inches of crushed gravel with paver stones or 4x4 stringers.

You can find the footprint for your shed on Page 3 of your Assembly Manual.



If doing the assembly yourself, have all the necessary tools ready to go and in working condition. A list of required tools can be found after the parts list.

## Foundation Types for 8x4 Garden Shed

1.

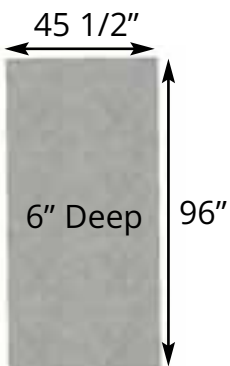

Concrete Foundation

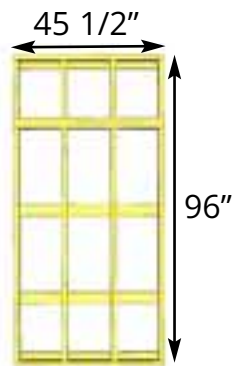

Floor Frame

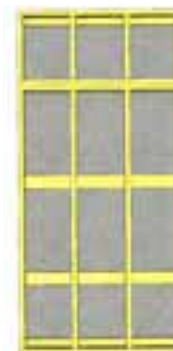

Completed Foundation

### Concrete Slab Foundation:

- Slab must be at least the same size as assembled floor frame (45 1/2" x 96") or larger.
- 6" Deep foundation.
- 0.6 Cubic Yards of concrete required.
- A concrete slab will have the longest durability out of your foundation options.

**Once level, a concrete slab is the easiest surface to build on.**

2.

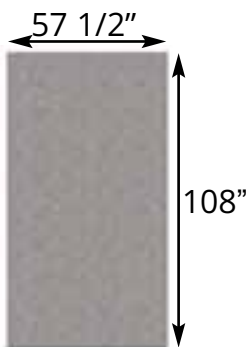

Gravel Foundation

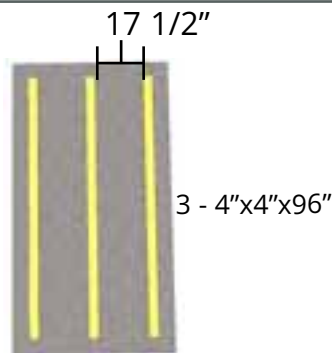

Gravel Foundation with treated stringers



Completed Foundation

### Gravel with 4x4 Pressure Treated Stringers:

- Excavate at least 6" deep, and 6" wider than floor frame on each side.
- 1.0 Cubic Yards of gravel required, approximately 9 wheelbarrows.
- 3 - 4x4 Pressure Treated Stringers 8' long required.
- Evenly spaced, with one at each end of floor frame.

**Saves money on materials, easy to level and work with.**

3.

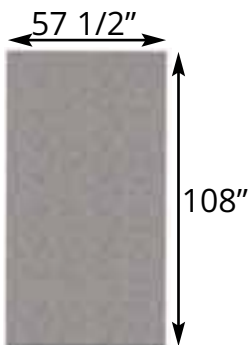

15 Patio Stones



### Gravel with Patio Paver Stones:

- Excavate at least 6" deep, and 6" wider than floor frame on each side.
- 1.0 Cubic Yards of gravel required, approximately 9 wheelbarrows.
- 15 patio pavers (8" x 8" or larger).
- Center patio paver stones underneath floor runners and underneath seams in floor joists.

**Patio paver stones are widely available from most landscape stores.**



# 8x4 SPACESAVER - SINGLE DOOR

## Hardware Kit - BASE KIT (Provided)

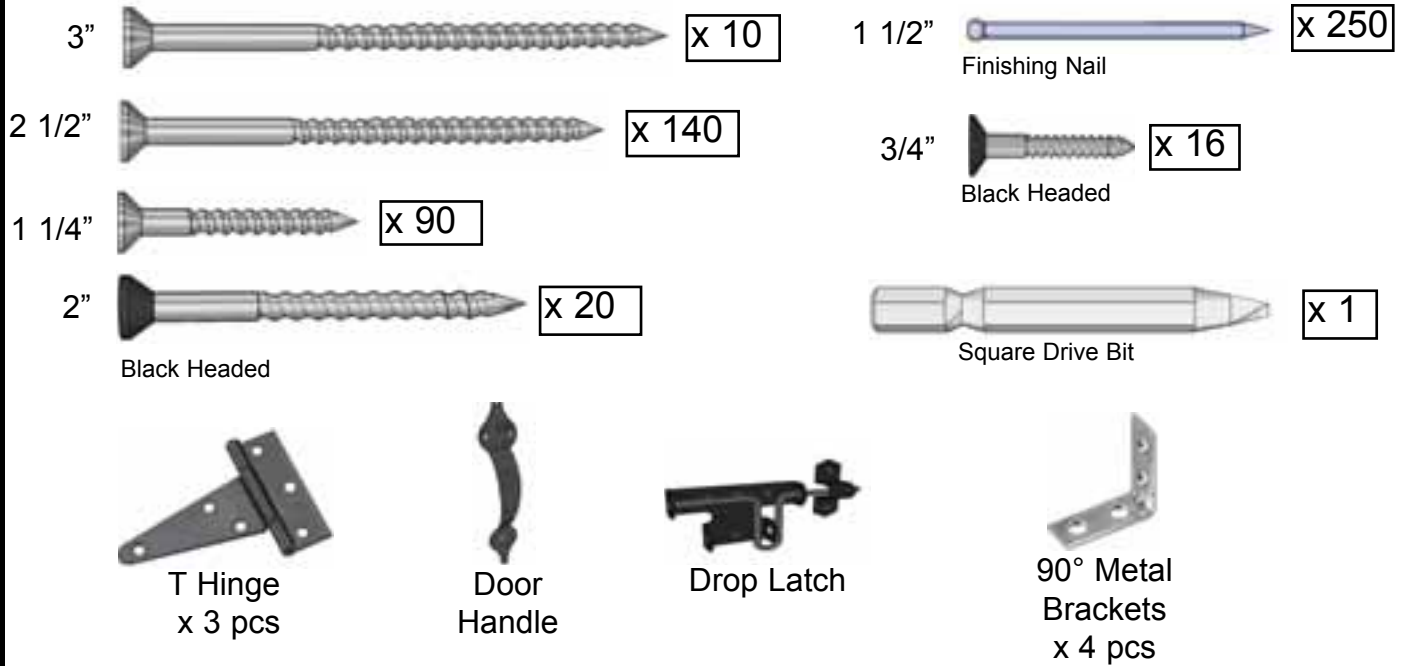

## Hardware Kit - CEDAR ROOF (Provided)

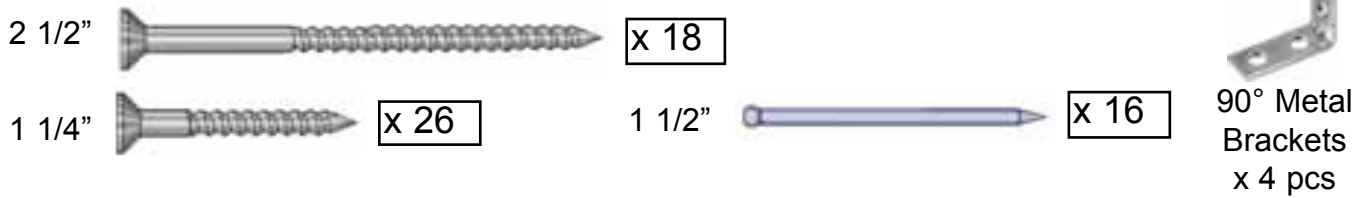

## Hardware Kit - METAL ROOF (Provided)



## Hardware Kit - PLYWOOD ROOF (Provided)

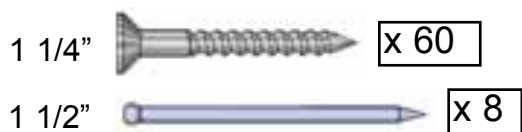

## Tools Required (Not Provided)



Hammer



Screw Gun/Drill



Tape Measure



Wood Clamp



3/8" Wrench



Level



Pliers



Ladder



1/8" & 3/8" Drill Bits



Utility Knife

## Safety Equipment Required (Not Provided)



Safety Glasses



Work Gloves

Assembly Manual shows instructions for the SpaceSaver (Low Front). Assembly instructions will diverge to note important differences between sheds. When following assembly steps keep your desired roof slope in mind relative to the doors.

SpaceSaver



GardenSaver



# Regular Maintenance & Tips to Prolong the Life of Your Shed.

## Before/During Assembly:

- 1.) Paint each face and edge of your plywood floor with a latex exterior paint.
- 2.) Caulk wall seams if gaps appear.
- 3.) Caulk around window framing (if applicable).
- 4.) Caulk perimeter between floor plywood and bottom wall plate.
- 5.) Caulk channels in lap siding at the top of your door above the trim, just a drop in each channel.
- 6.) Caulk edge of door threshold (if applicable).
- 7.) Optional: Install a Sill Gasket between floor runners and foundation.
- 8.) Optional: Install an 8" strip of roofing paper below Cedar Ridge Caps for Cedar Roof Sheds.

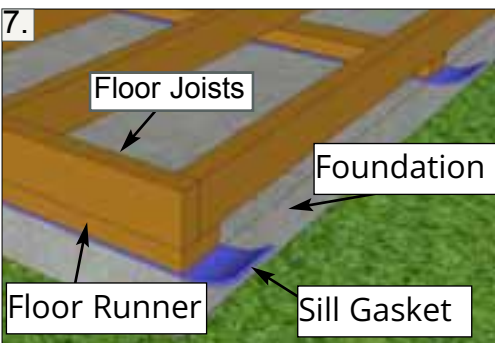
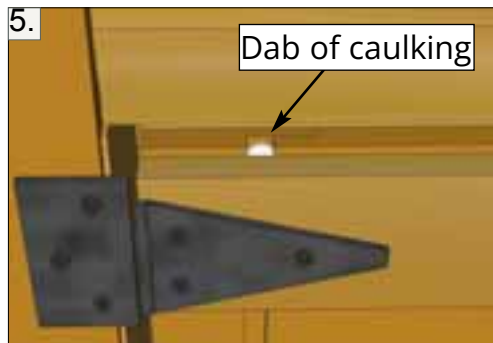
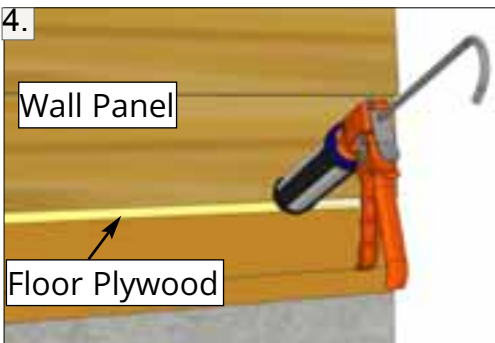

## Routine Maintenance:

- Routinely check all fasteners are tight (ex. Door Hinges, Nails)
- Brush off dirt from walls.
- Brush off snow from roof regularly.
- Routinely remove needles and leaves from roof.

## Painting/Staining

- Your cedar shed, if left untreated, will weather to a silvery grey colour.
- Painting or staining your structure is highly recommended and will prolong the life of your shed.
- You do not need to wait to paint or stain your shed, the wood in your kit has been dried and can be stained or painted immediately.
- Consult your local paint store for the best paint or stain for cedar.
- Optional: stain the inside of your shed. (Note: this will remove the fresh cedar smell.)

# A. Floor Section

Exploded view of all parts necessary to complete Floor Section. Identify all parts prior to starting.  
Note: Floor Footprint is 96" wide x 45 1/2" deep.

Floor Section will be installed the same way for both SpaceSaver and GardenSaver.

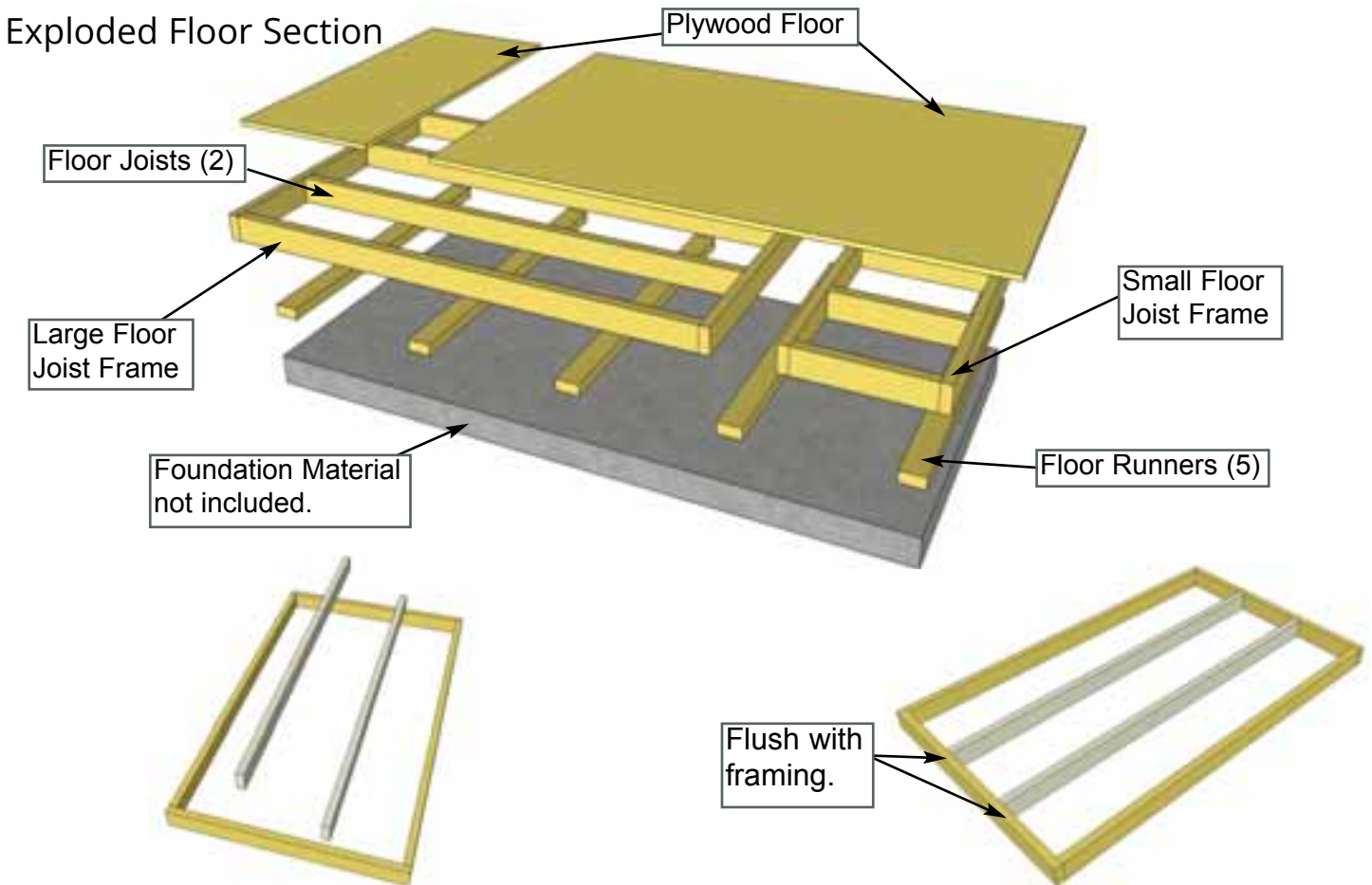

**A1.** Lay out **Large Floor Joist Frame** and **2 Floor Joists** (1 1/2" x 3 1/2" x 71 7/8") as illustrated above. Position Joists equally in Floor Joist Frame. Use Small Floor Joist Frame as a template to determine joist position. Position Joist so flush with framing.

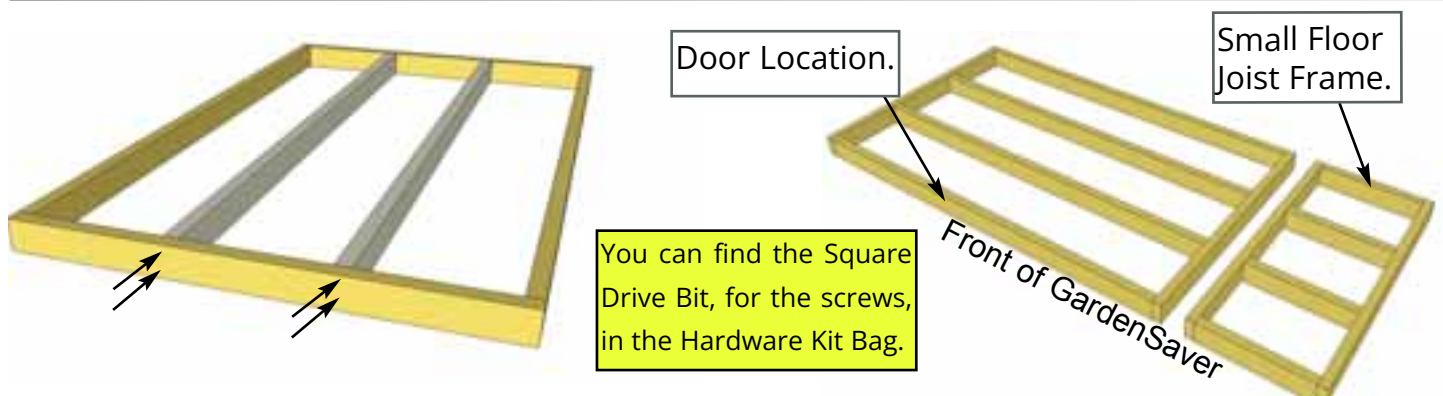

**A2.** When correctly positioned, attach each Joist with **4 - 2 1/2" Screws** (2 per end). You can find the **Square Drive Bit** for the screws in with the **Hardware Kit Bag**.

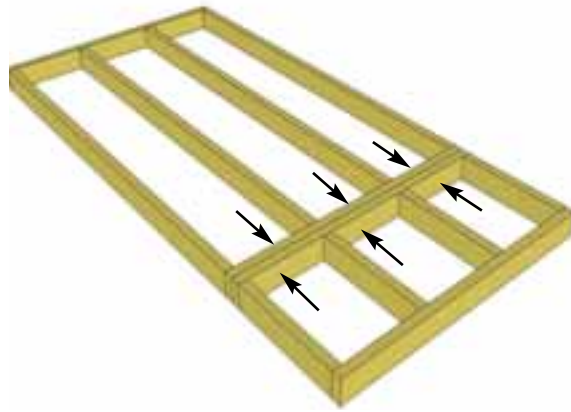

**A3.** With Floor Joist Frames positioned together flush, attach with **6 - 2 1/2" Screws**.

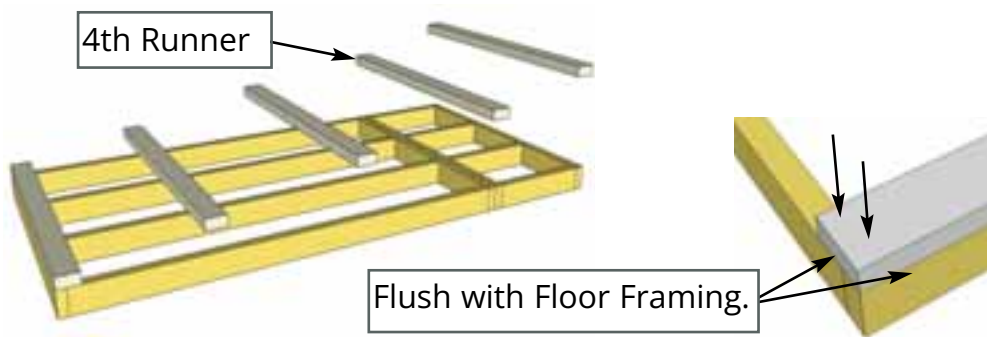

**A4.** Position and attach **Floor Runners** (1 1/2" x 3 1/2" x 45 1/2") to completed floor frames with **6 - 2 1/2" Screws** per Runner. Make sure Runners are flush with outside of floor framing but not overhanging. Make sure 4th Runner is placed equally over seam where floor frames

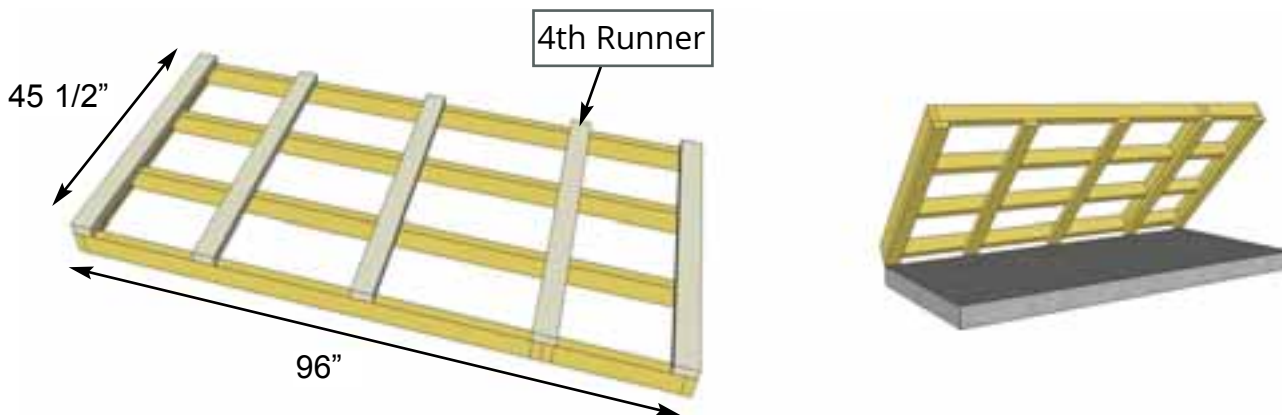

**A5.** With Floor Runners attached, carefully flip the floor over and place on your foundation. Caution - you may need 2 people to assist you. Be careful when laying floor down not to bend or twist floor. Note: The floor will be flipped over and floor runners will sit on your foundation. It is important to note that having a level foundation is critical. Choosing a foundation will vary between regions. Typical foundations can be concrete pads or patio stones positioned underneath the floor runners.

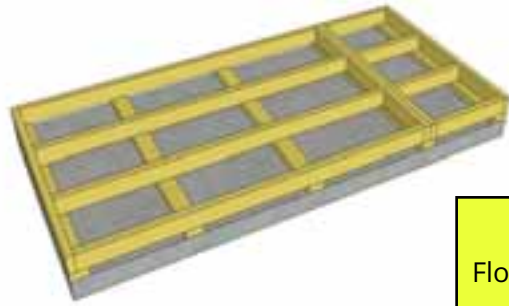

**Important:**

Floor should be completely level before moving to next step.

**A6.** When in place, level floor completely before proceeding.

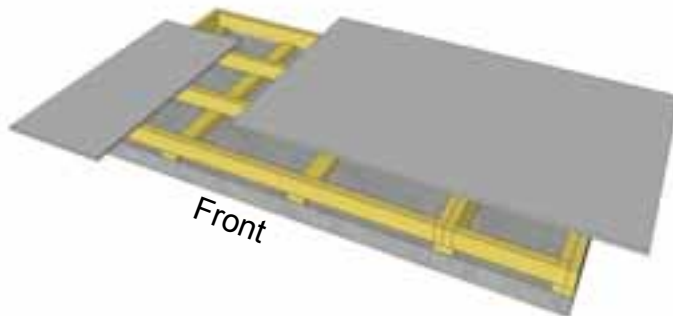

**A7.** Position **Plywood Floor pieces** (2) on top of completed floor joists.

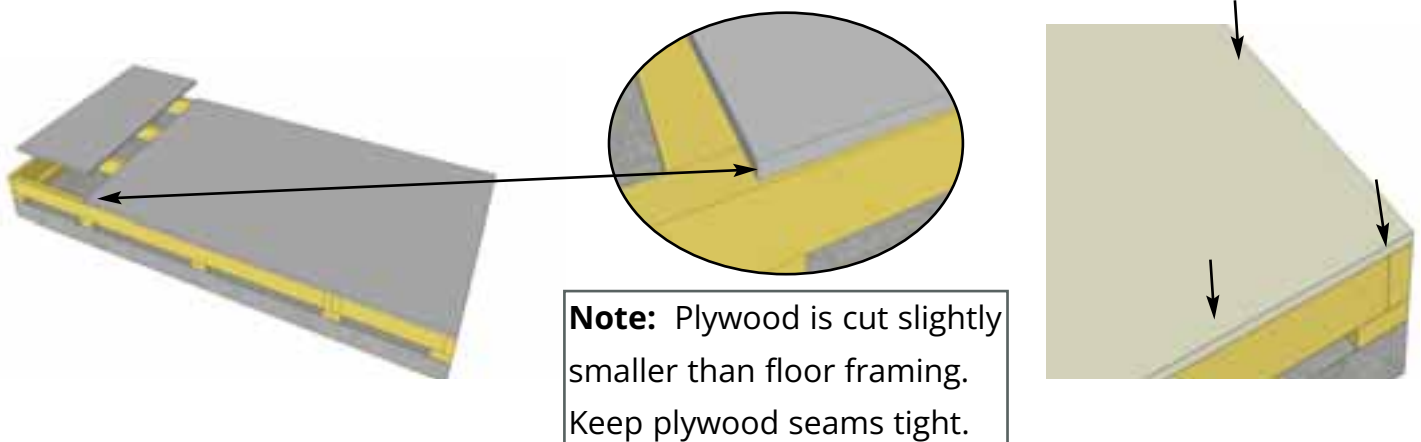

**Note:** Plywood is cut slightly smaller than floor framing. Keep plywood seams tight.

**A8.** Position **Plywood** so it sits almost flush with outside of floor joist framing (**see Note**). When correctly positioned, attach to all floor joists with approximately **24 - 1 1/4" Screws**. Use screws every 16".

# B. Wall Section

Exploded view of all parts necessary to complete the Wall Section. Identify all parts prior to starting.

Wall Section will be installed the same way for both SpaceSaver and GardenSaver. When following assembly steps keep your desired roof slope in mind relative to the door.

## SpaceSaver

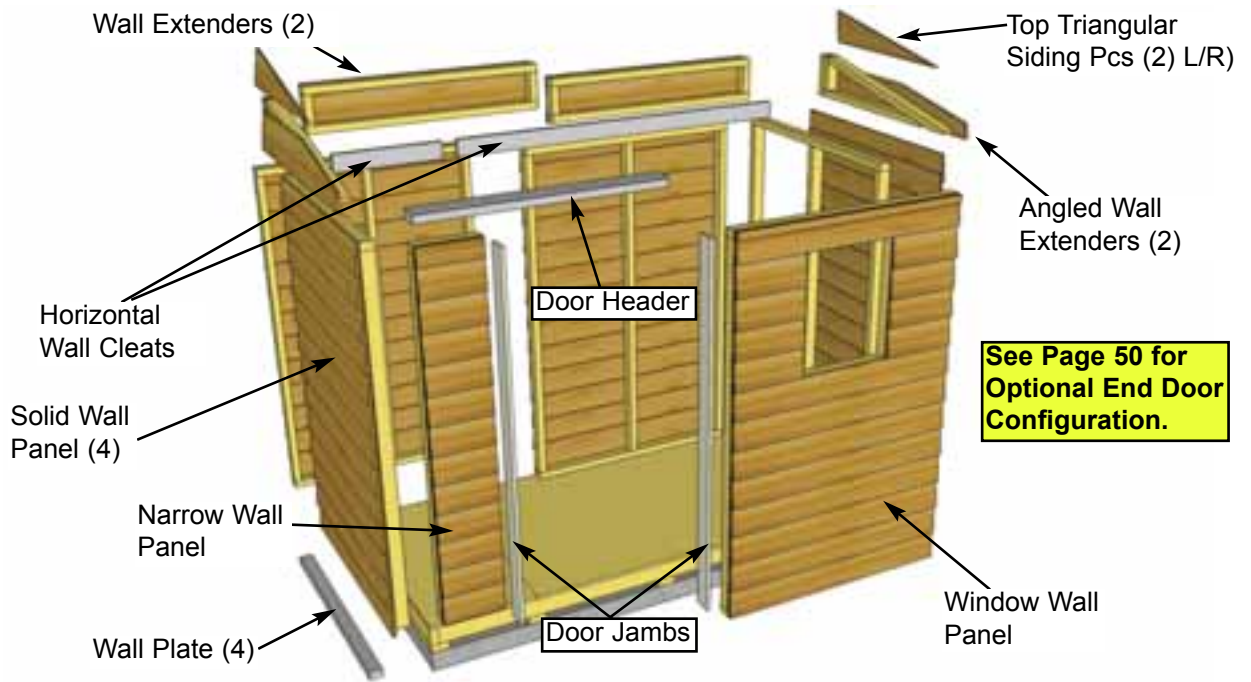

## GardenSaver

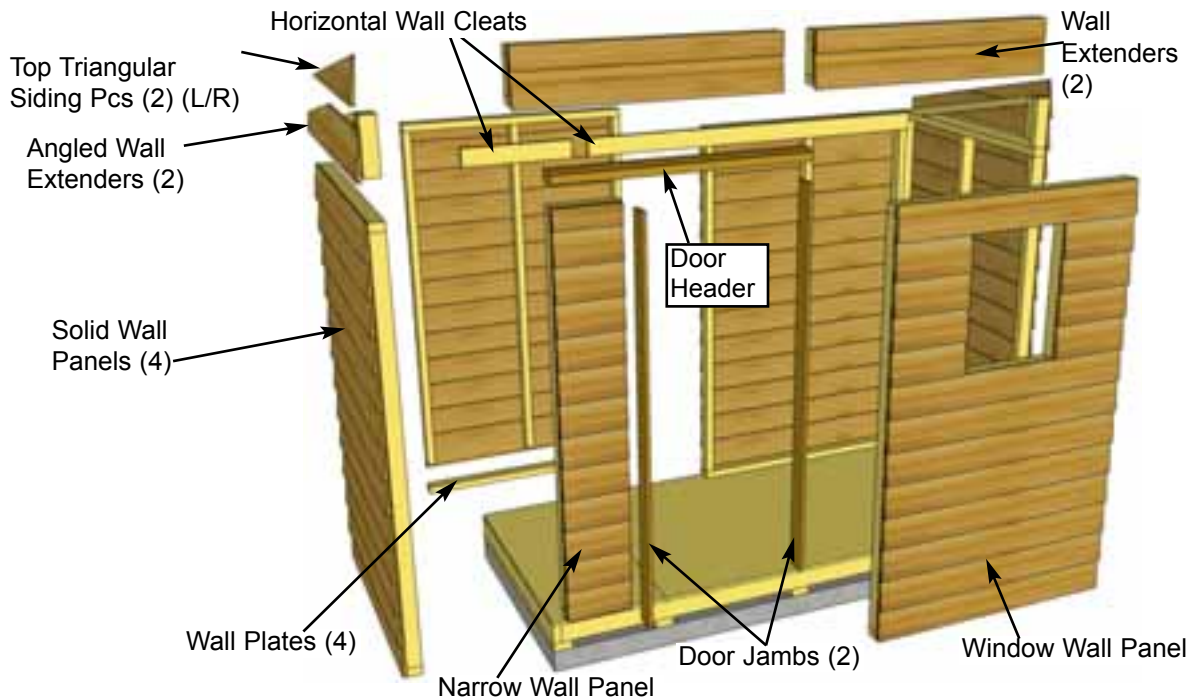

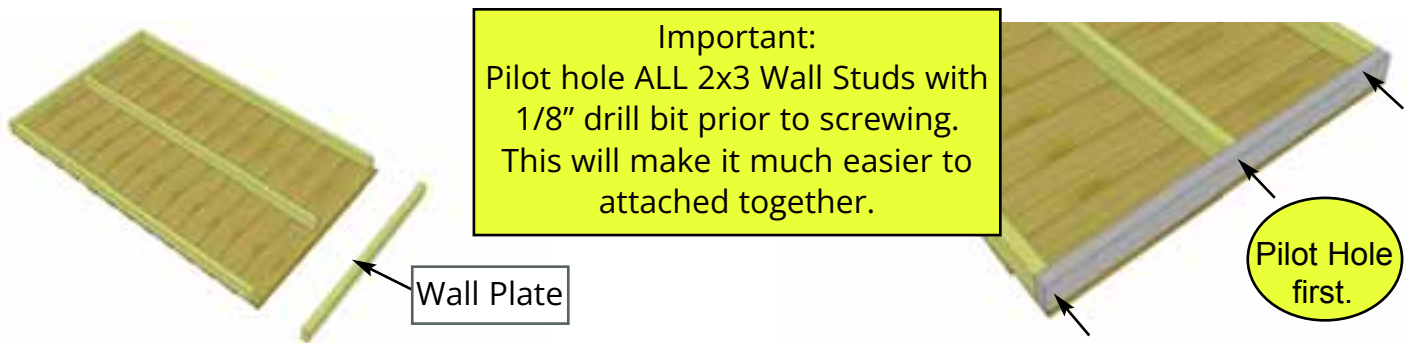

**B1.** Locate **4 Solid Wall Panels** and **4 Wall Plates** (1 1/2" x 2 1/2" x 45 1/2"). Attach Plates to bottom of studs of each wall panel with **3 - 2 1/2" Screws**. Position so plates are flush with framing.



**B2.** Starting on side, position a **Solid Wall Panel** on top of plywood floor. The Wall Panel bottom framing will sit flush with floor framing. Wall siding will overhang the floor. **Important:** Make sure all walls are aligned in their upright position. If not, water may leak into your shed. Unsure if panel is facing up or down? Recently attached Bottom Plate is on bottom of panel.

Do not align wall siding to floor. Align wall plate to outside of plywood floor.

Wall Plate Flush with floor framing.

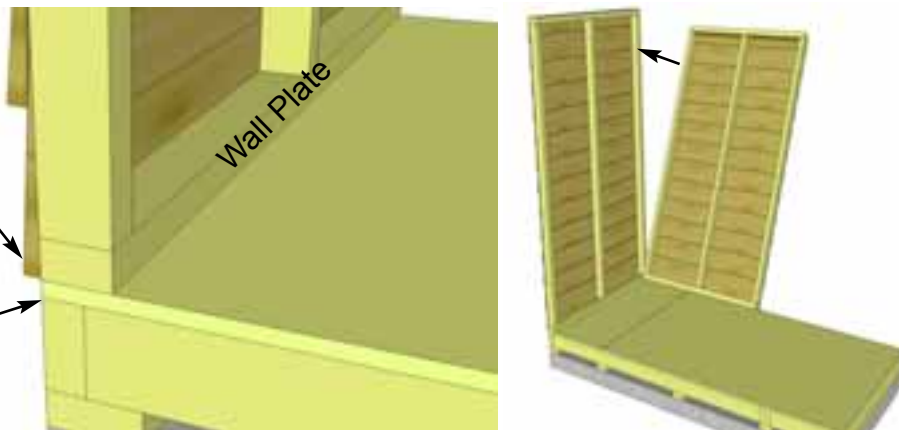

**B3.** Outside 2x3 framing of wall panel should be flush with outside of floor framing when properly aligned. **Note:** Do not align wall siding to floor. Align wall plate to outside of plywood floor. When positioned correctly, locate 2nd Solid Wall Panel and place in corner.

Do Not Attach Walls To Floor until B22.

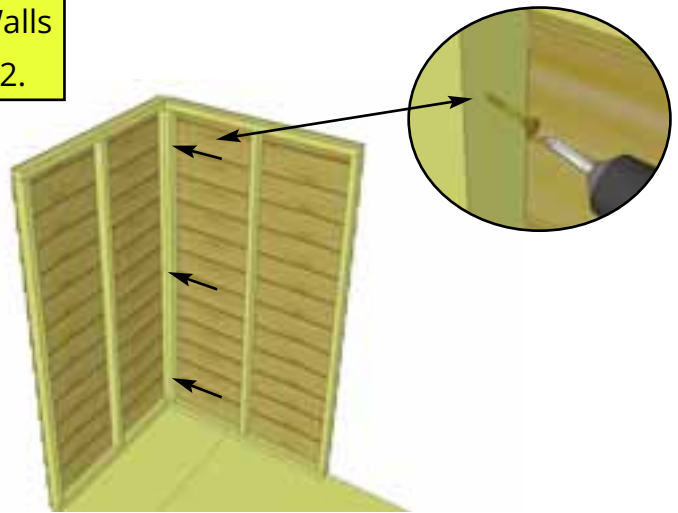
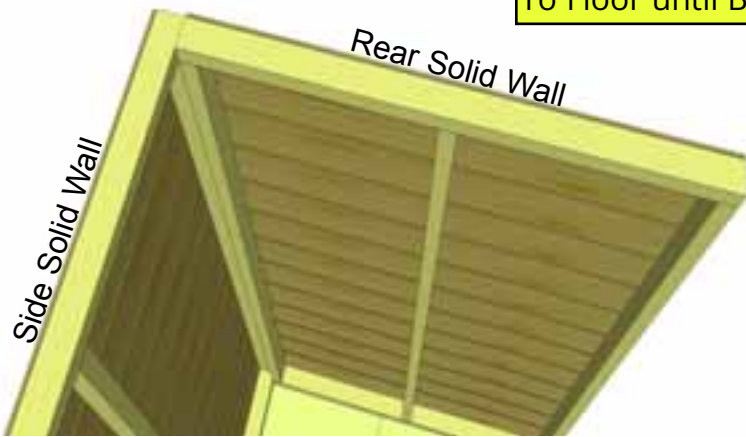

**B4.** Butt both vertical wall studs of side and rear walls together and attach with **3 - 2 1/2" Screws**. Screw at the bottom, middle and top of stud to secure properly. Have helper push wall framing together while securing to ensure tight fit.



**B5.** With the corner wall attachment complete, position the second **rear wall panel** in place so bottom 2x3 wall framing is sitting flush with outside floor framing. Wall siding should overhang floor by approximately 3/4". When positioned correctly, attach both wall panel studs together as per Step B4 with **3 - 2 1/2" Screws**.

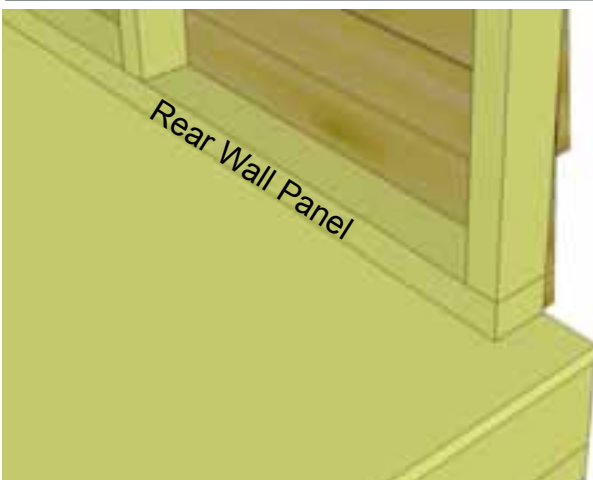

Do Not Attach Walls To Floor until Step B22.



**B6.** With Rear Wall Panel in place, position other side wall panel on floor as per **Step B4 & B5**.



**B7.** Secure **side wall panel** to rear wall panel as per **Step B4**. Next, locate the Narrow Wall Panel and position in front.

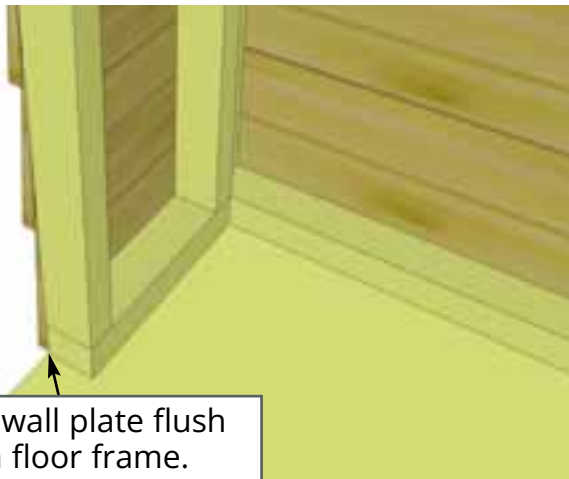

2x3 wall plate flush with floor frame.

**B8.** Once again position the 2x3 wall plate so it sits flush with floor framing and siding overhangs. **Note:** Narrow Wall Panel is only 73" high.

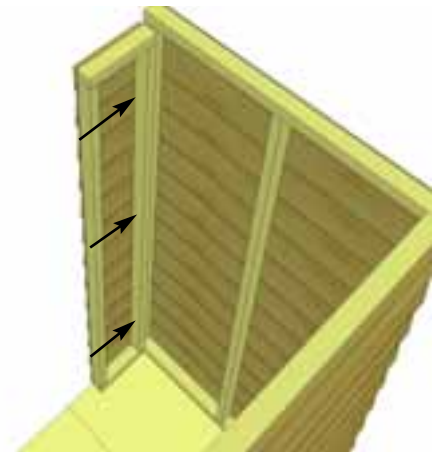

**B9.** When correctly positioned, secure Narrow Wall Stud to Side Wall Stud with **3 - 2 1/2" Screws**.

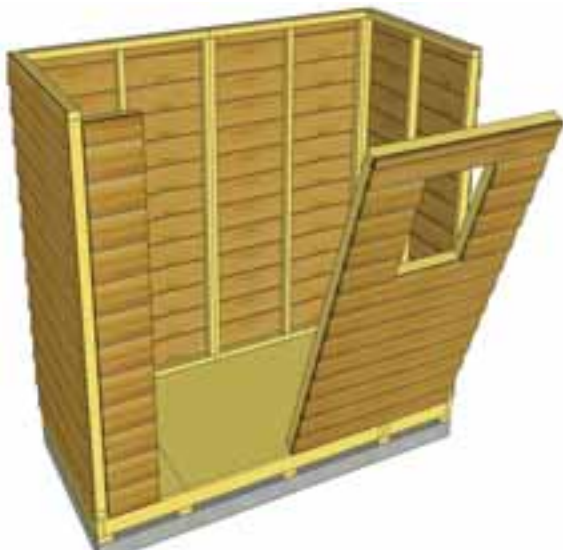

**B10.** Align front corner Window Wall Panel as per **Steps B8 & B9**. using **3 - 2 1/2" Screws** to secure wall studs together.

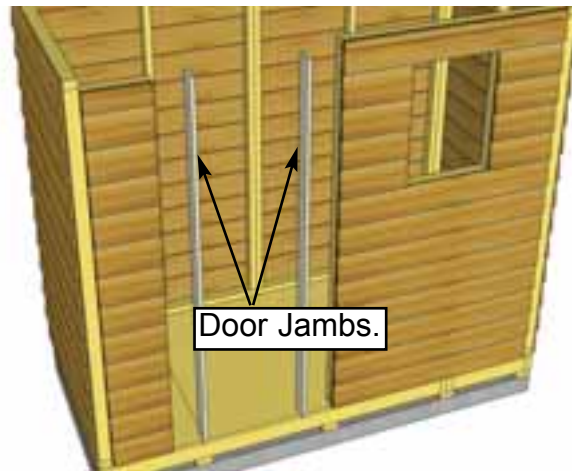

**B11.** Locate **Door Jambs** (2 @ 3/4" x 3 1/2" x 73") and place on either side of door opening.

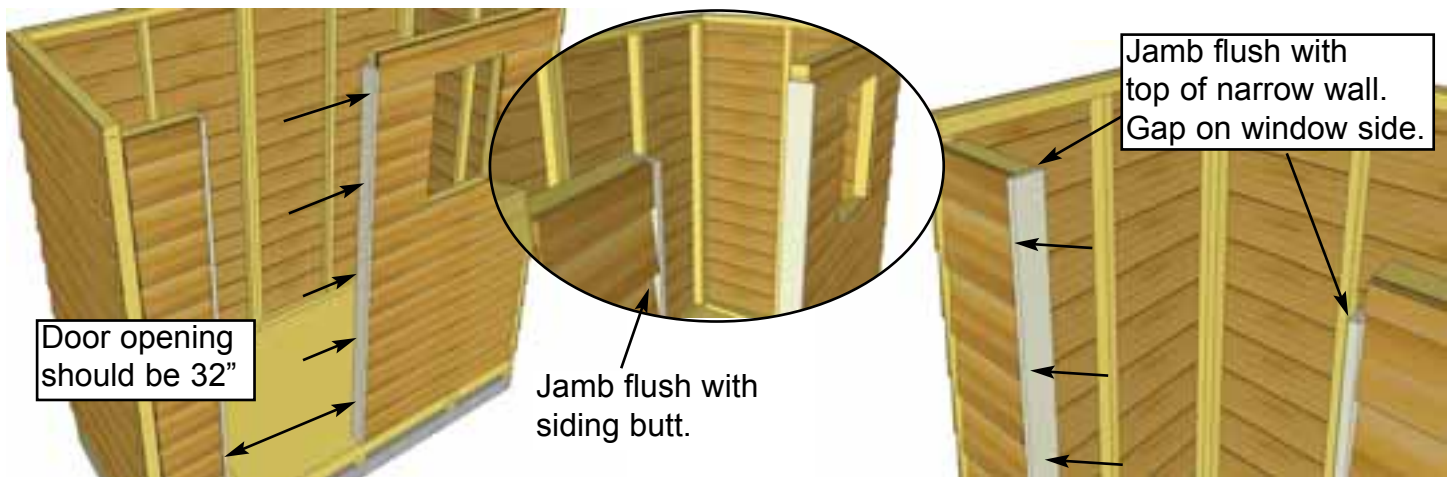

**B12.** Position **Door Jambs** flush against narrow and window wall studs and tight to floor. The Jamb is 3 1/2" wide and will sit flush to outside of wall siding. When positioned correctly, secure **Jambs** using **4 - 2 1/2" Screws**. With both door jambs secured, confirm 32" door opening.

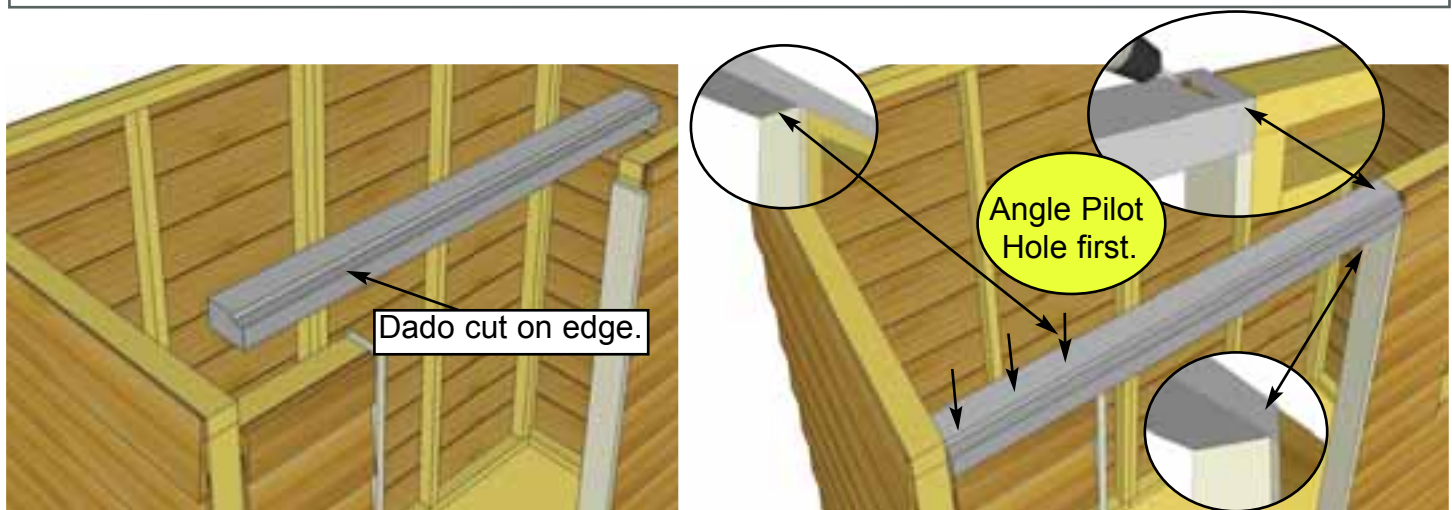

**B13.** Position and attach the **Door Header** to top of **Narrow Wall** framing and against window wall framing resting on top of door jambs. Header should sit flush on **Door Jambs**. Attach with **4 - 2 1/2" Screws**. On window side, screw about 1" from end of header at angle into window wall framing. Pilot hole first.

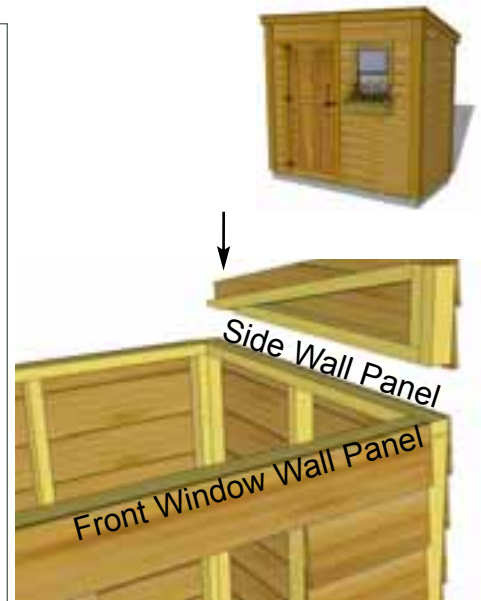
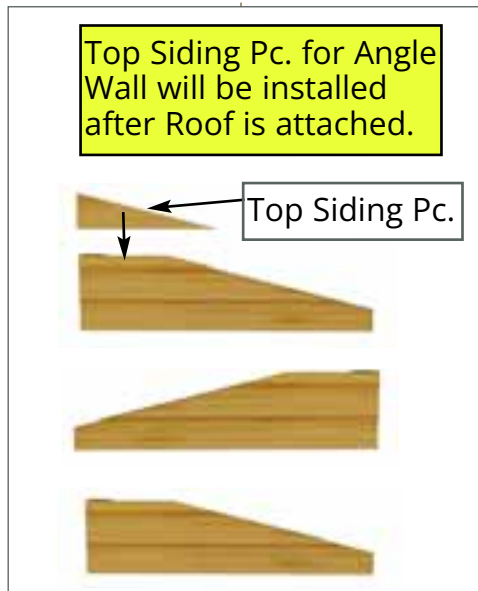
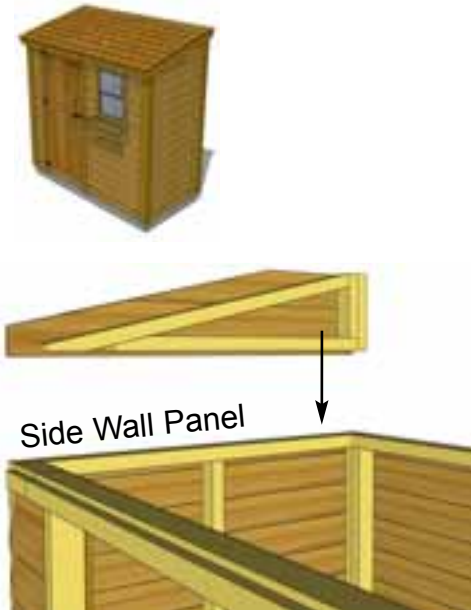

**B14.** Locate both **Angled Wall Extenders (L/R)**. Place first wall extender on side wall panel frame. **Note:** Bottom siding of wall extender will overhang and cover siding of side wall.

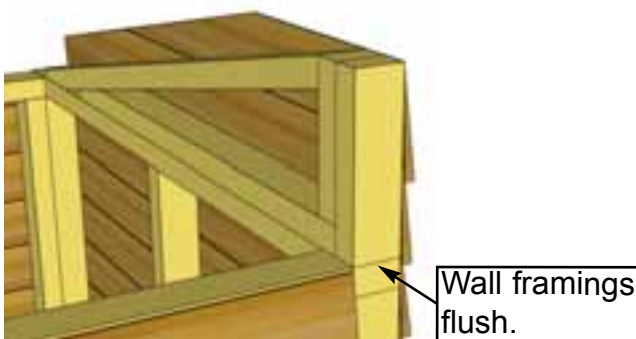
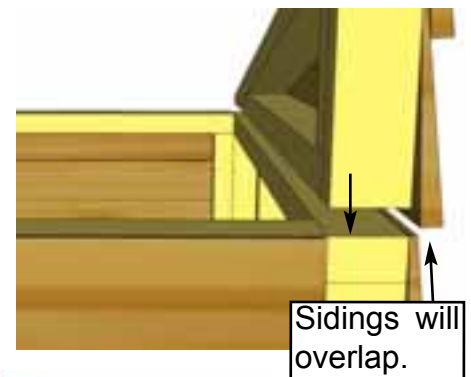
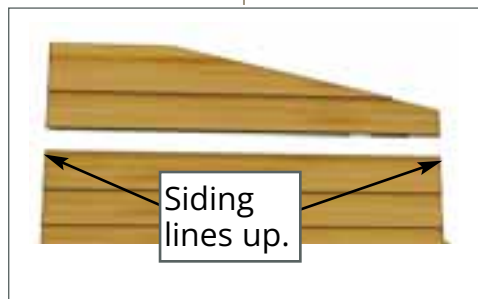
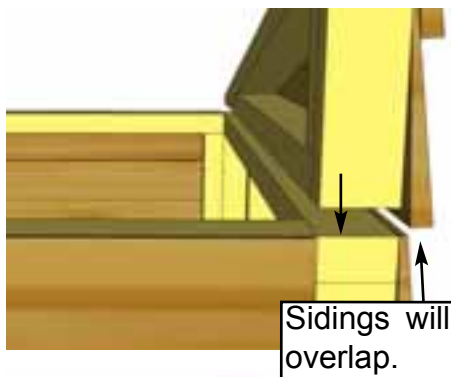

**B15.** Align wall framing of **Angled Wall Extender** and Side Wall so they are flush at the back. The siding for both walls should also align evenly from front to back.



**B15.** Align wall framing of **Angled Wall Extender** and Side Wall so they are flush at the front. The siding for both walls should also align evenly from front to back.

# SPACESAVER

# GARDENSAVER

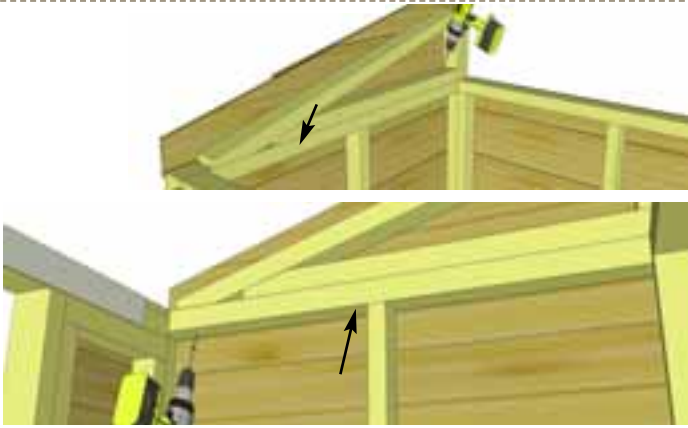

**B16.** With Angled Wall Extender and Side Wall aligned correctly, secure together from the inside with 4 - 2 1/2" Screws.

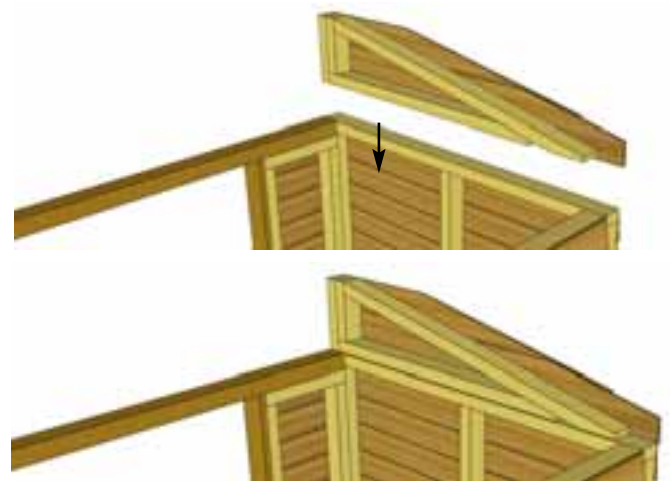
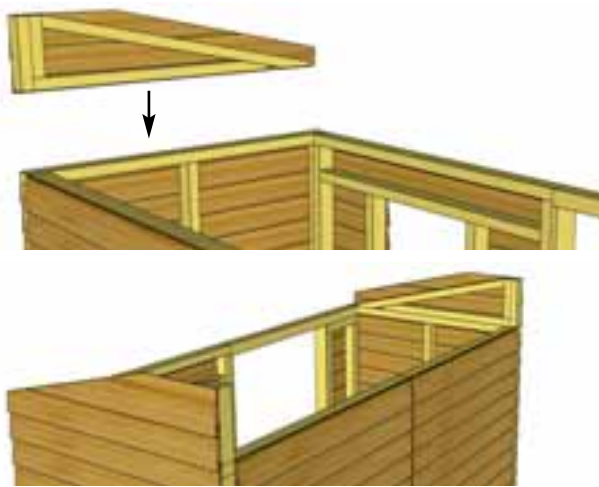

**B17.** Complete opposite Angled Wall Extender positioning and attachment as per Steps B15 & B16.

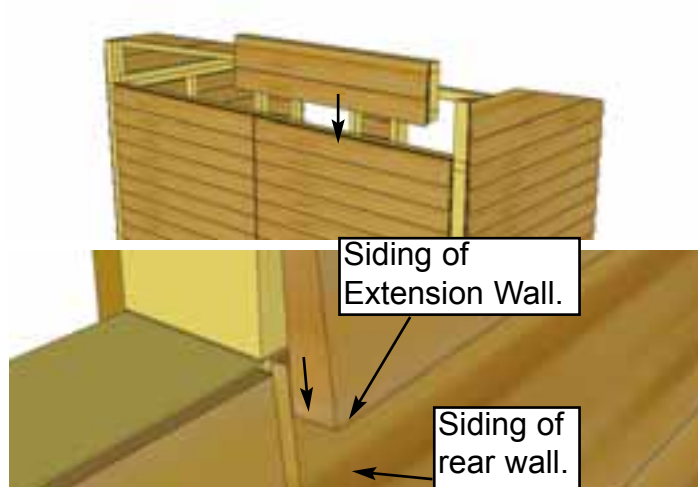

**B18.** Locate one Wall Extender and place on rear wall panel with siding of extender overlapping that of the rear wall.

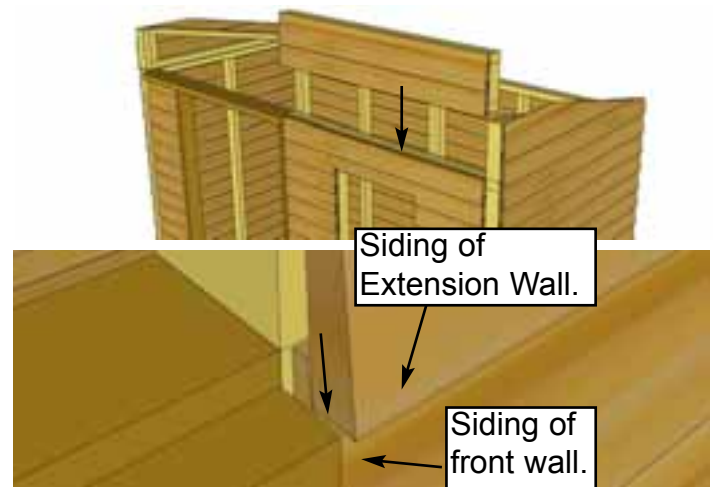

**B18.** Locate one Wall Extender and place on front window wall panel with siding of extender overlapping that of the front window wall.

# SPACESAVER

# GARDENSAVER

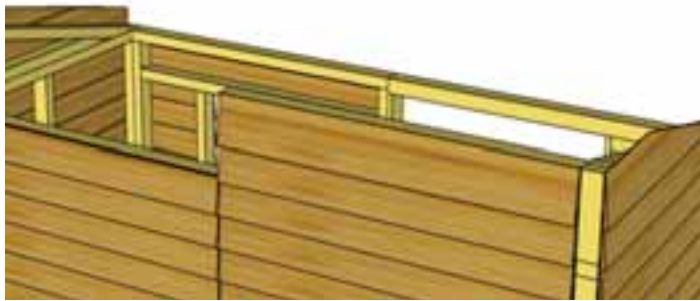
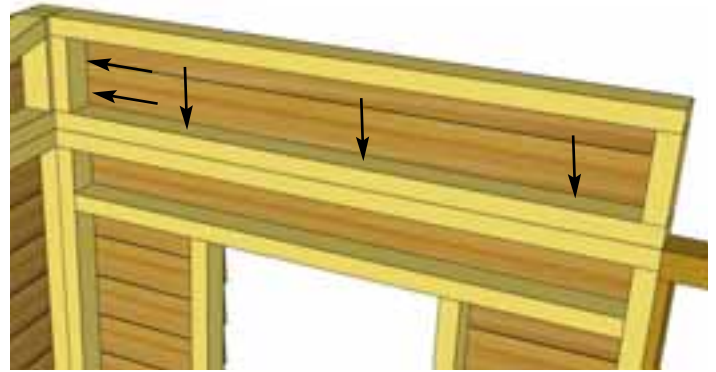
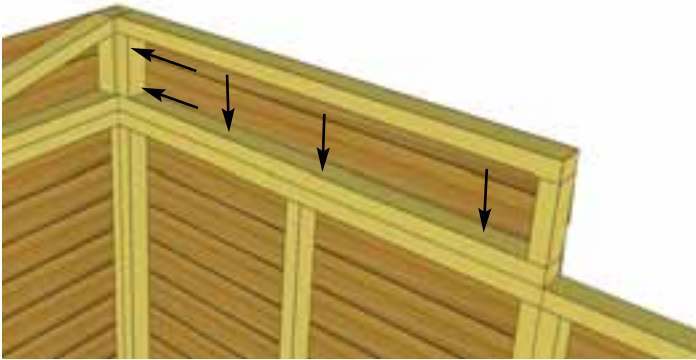

**B19.** With 2x3 wall framing aligned, attach Wall Extender to both the Angled Wall Extender framing and the rear wall framing with 5 - 2 1/2" Screws.

**B19.** With 2x3 wall framing aligned, attach Wall Extender to both the Angled Wall Extender framing and the front window wall framing with 5 - 2 1/2" Screws.

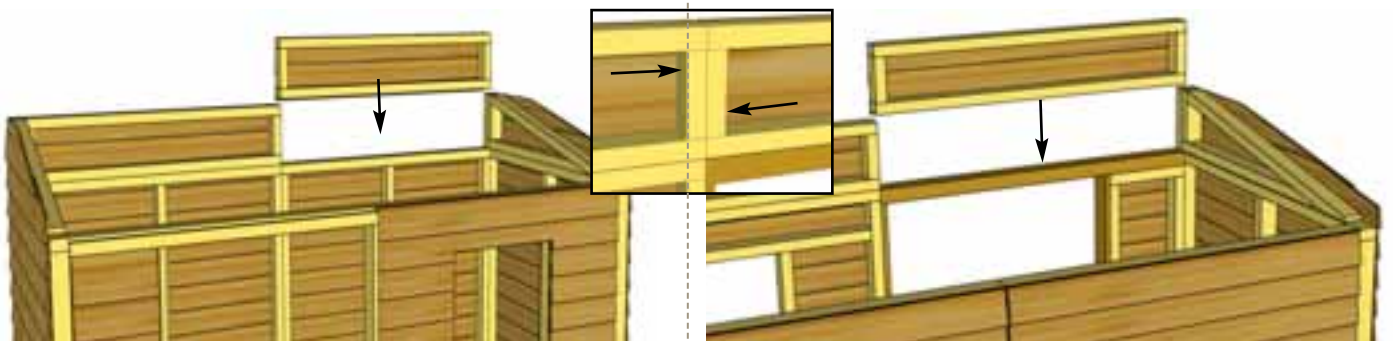

**B20.** Position and secure 2nd Wall Extender Panel as per Steps B18 & B19. Additionally, attach to first Extender with 2 - 2 1/2" Screws.

# SPACESAVER

# GARDENSAVER

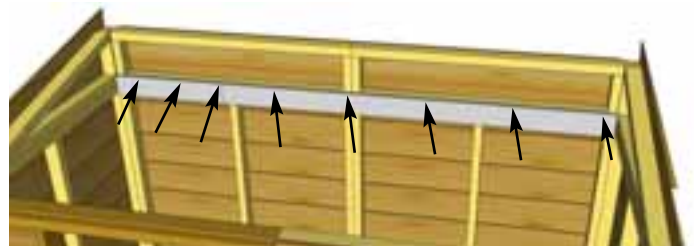
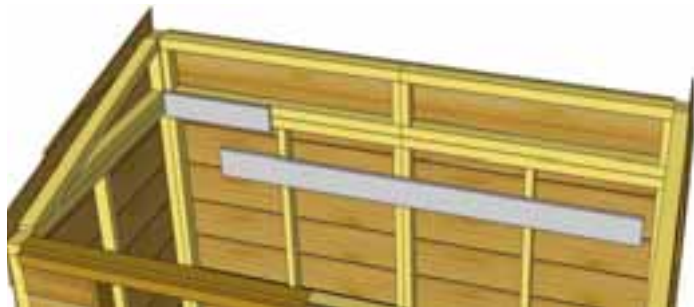

**B21.** Attach **Horizontal Wall Cleats** (1 @ 3/4" x 3 1/2" x 70", 1 @ 3/4" x 3 1/2" x 21") to Wall Extender bottom framing and Rear Wall top framing, so that cleat is flush with extender framing. There is a short and a long wall cleat. Alternate alignment of screws, so half screw into Wall Extender Framing and half into Rear Wall Top Framing. Use **8 - 1 1/4" Screws**.

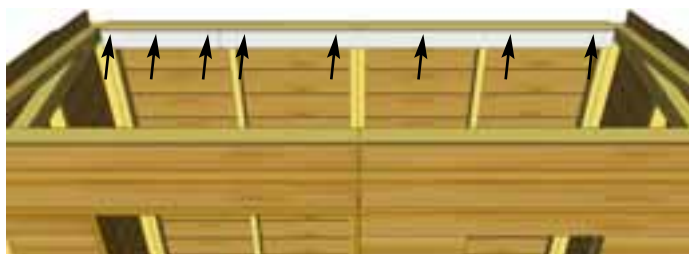
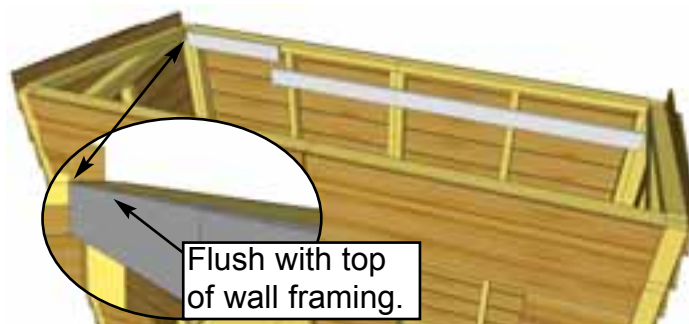

**B21.** Align **Horizontal Wall Cleats** (1 @ 3/4" x 3 1/2" x 70", 1 @ 3/4" x 3 1/2" x 21") flush with top of Rear Wall framing. To help strengthen the Rear Walls, there is a short and a long wall cleat which meet off-center from the seam between walls. Attach Cleats with **8 - 1 1/4" Screws**.

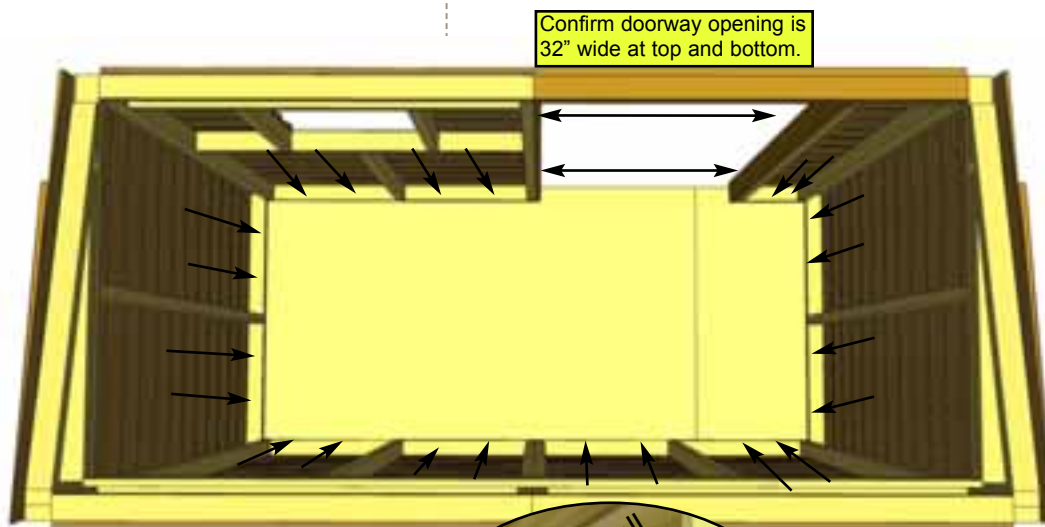

Confirm doorway opening is 32" wide at top and bottom.

**Optional** - Caulking seams will help prevent moisture from entering at seam. Caulking not included in kit.

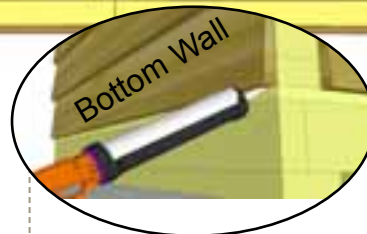

**B22.** To complete Wall Section, attach bottom 2x3 wall plates to plywood floor with **22 - 2 1/2" Screws**. Confirm Doorway opening is 32" wide. Prior to securing, make sure wall panels are aligned correctly on the floor. Wall siding should overhang floor while 2x3 wall plates should sit flush with floor.

# C. Rafter Section

Exploded view of all parts necessary to complete the Rafter Section. Identify all parts prior to starting.

Rafter Section will be installed the same way for both GardenSaver and SpaceSaver. When following assembly steps keep your desired roof slope in mind relative to the door.

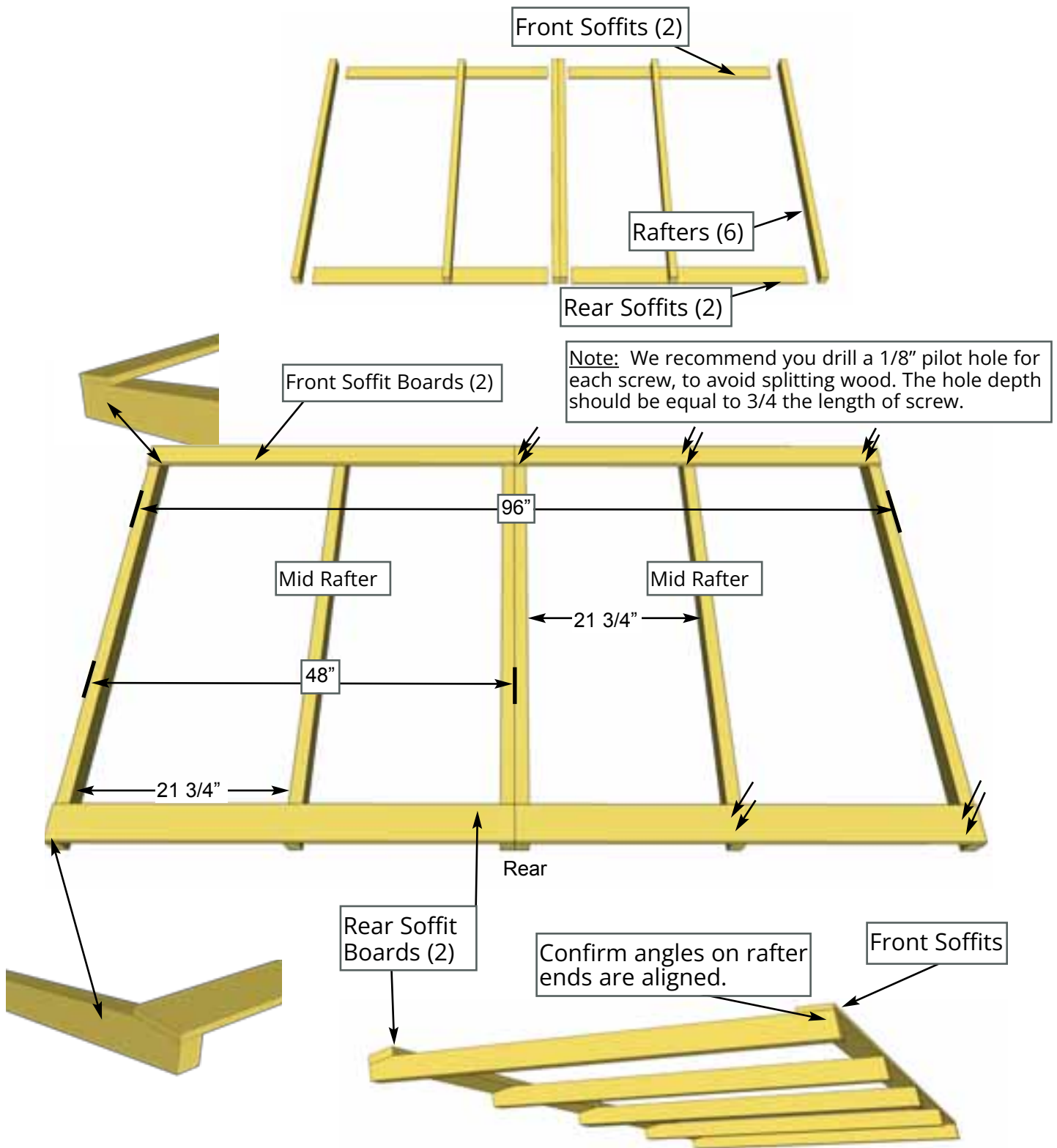

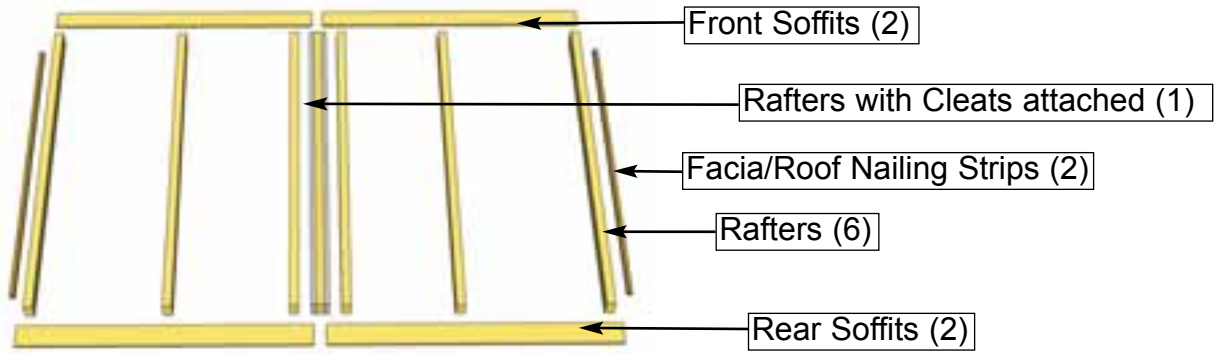

**Note - Rafter Section for Plywood Roof with have an extra Rafter with Cleats attached.**

**C1.** For Sheds with Cedar and Metal Roofs - Locate 6 **Rafters** and 4 **Soffits**. Lay out on level ground and assemble as shown in Illustrations **A** through **C** below. Attach Soffit Boards flush to end of outside rafters with 2 - 1 1/4" Screws per rafter end. **Important:** Drill pilot holes in Soffit ends to prevent splitting. Measure and attach interior Rafters as illustrated above. Measure and attach remaining Soffit/Rafter connections using 2 - 1 1/4" Screws per rafter/soffit.

For Sheds with Plywood Rood - Locate 7 **Rafters**, 4 **Soffits**. Center Rafter has 3/4" cleats attached on both sides making the width 3". Lay out on level ground and assemble as shown in Illustrations **A** through **C** below. Attach Soffit Boards flush to end of outside rafters with 2 - 1 1/4" Screws per rafter end. **Important:** Drill pilot holes in Soffit ends to prevent splitting. Measure and attach remaining Soffit/Rafter connections using 2 - 1 1/4" Screws per rafter/soffit.

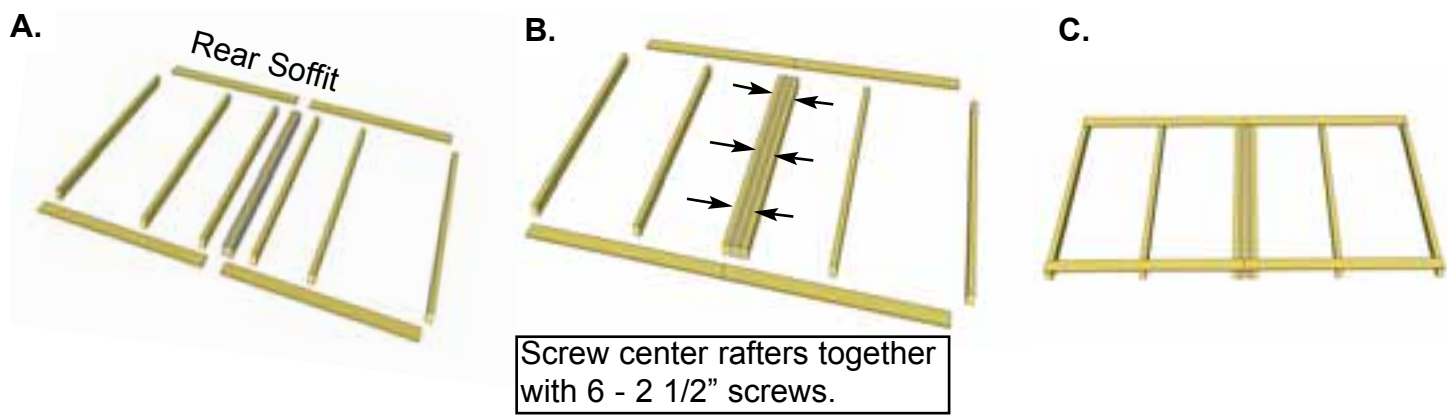
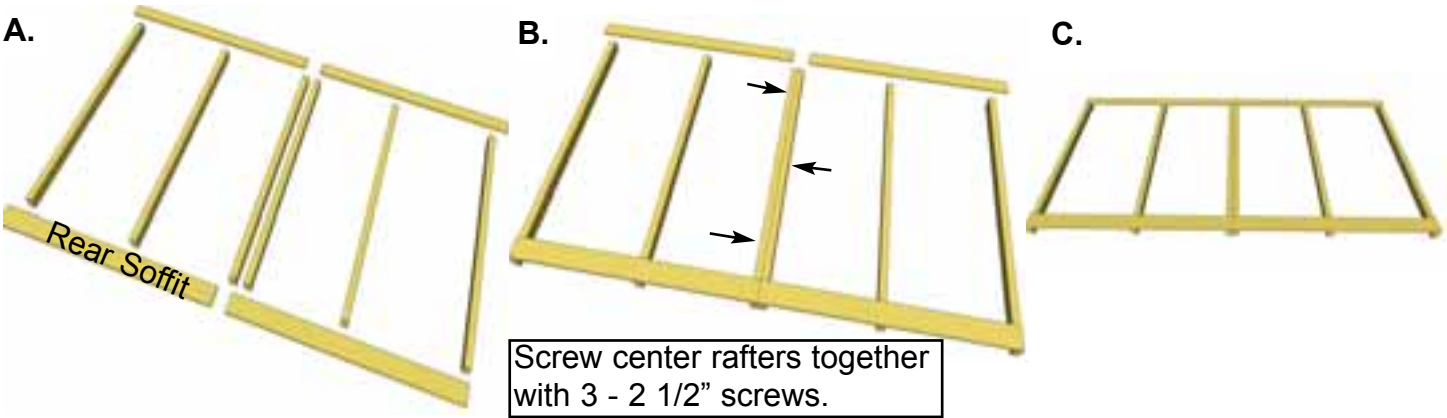

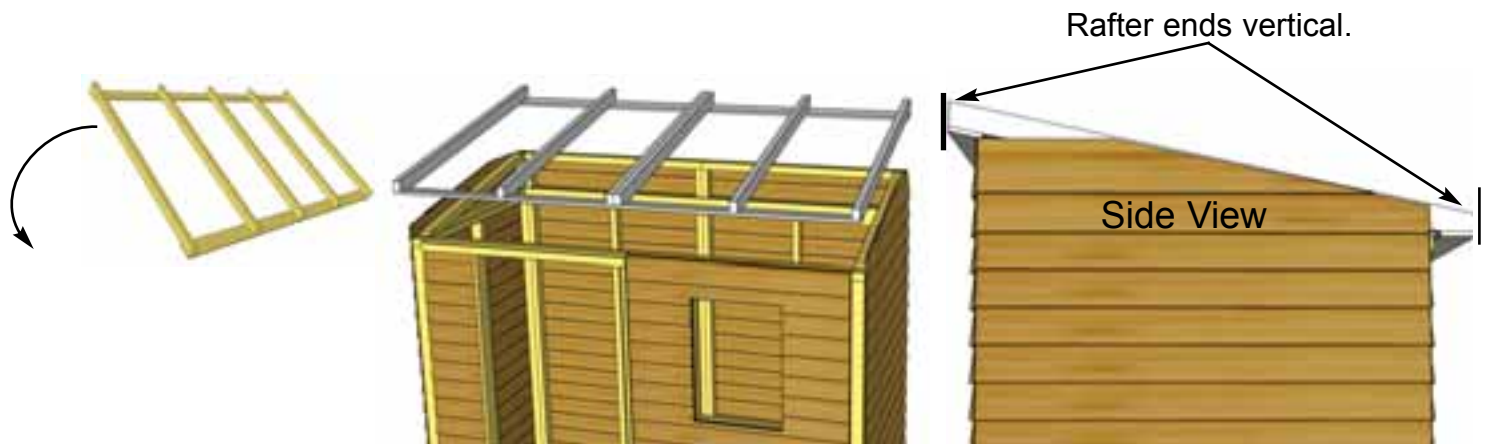

**C2.** Carefully flip completed Rafter Section over so Front Soffit is facing the front and place on SpaceSaver walls. **Note:** Double check that your Rafter Section is positioned correctly by ensuring the ends of the Rafters are sloped vertically as shown above.



**C3.** Position completed Rafter Section on top of walls. Outside Rafters will sit on Extension Wall framing and be positioned equally from side to side.



**C4.** When Rafter Section is positioned correctly, Front Soffits will sit approximately 1/8" away from wall siding. The Rear Soffit may touch wall siding. This can vary slightly.

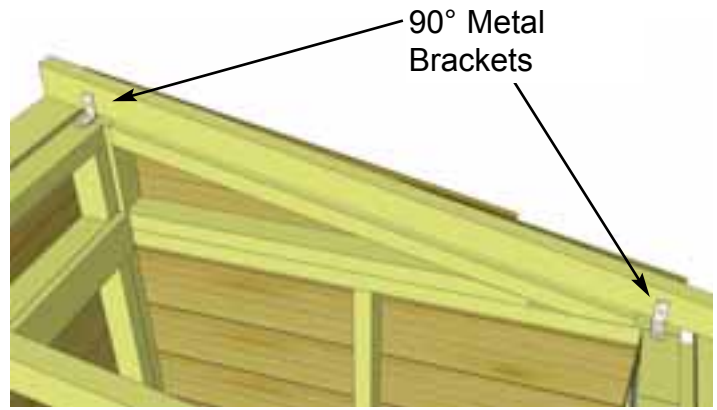
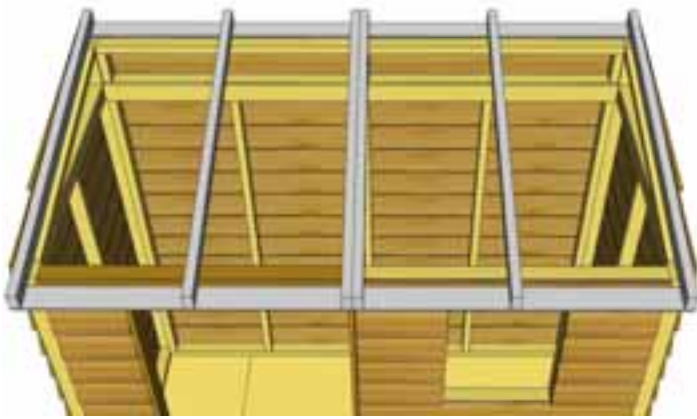

**C5.** With Rafter Section correctly aligned, secure rafters to walls using **90° Metal Brackets**. Start with outside rafters and secure 2 Brackets with **1 1/4" Screws**. Screw into Wall Extension Framing at the rear and Wall Panel top framing at the front. Complete both sides.

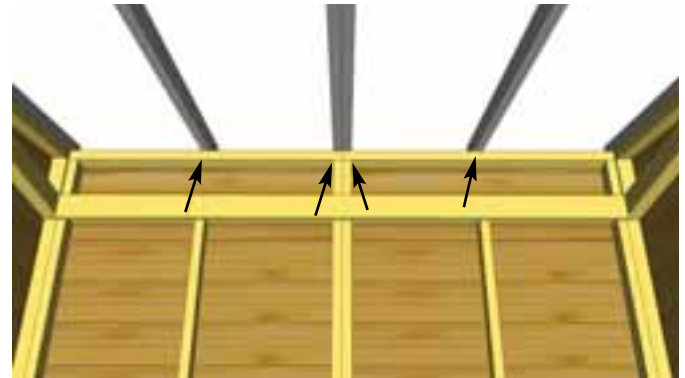
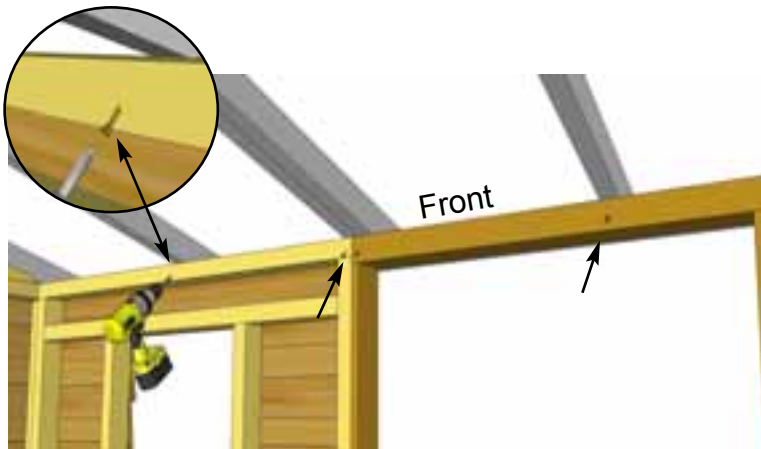

**C6.** With outside rafters properly secured, completely secure remaining interior rafters using **8 - 3" Screws**. Screw into rafters from inside of Header on an angle at front of shed, and from inside of Extension Wall Framing at rear of shed.

**If you have purchased a CEDAR Roof, please proceed to page 24.  
If you have purchased a METAL Roof, please proceed to page 29.**

# D. Roof Section - Cedar

Exploded view of all parts necessary to complete the Rafter and Roof Section. Identify all parts prior to starting.

Roof Section will be installed the same way for both GardenSaver and SpaceSaver. When following assembly steps keep your desired roof slope in mind relative to the door.

## SpaceSaver

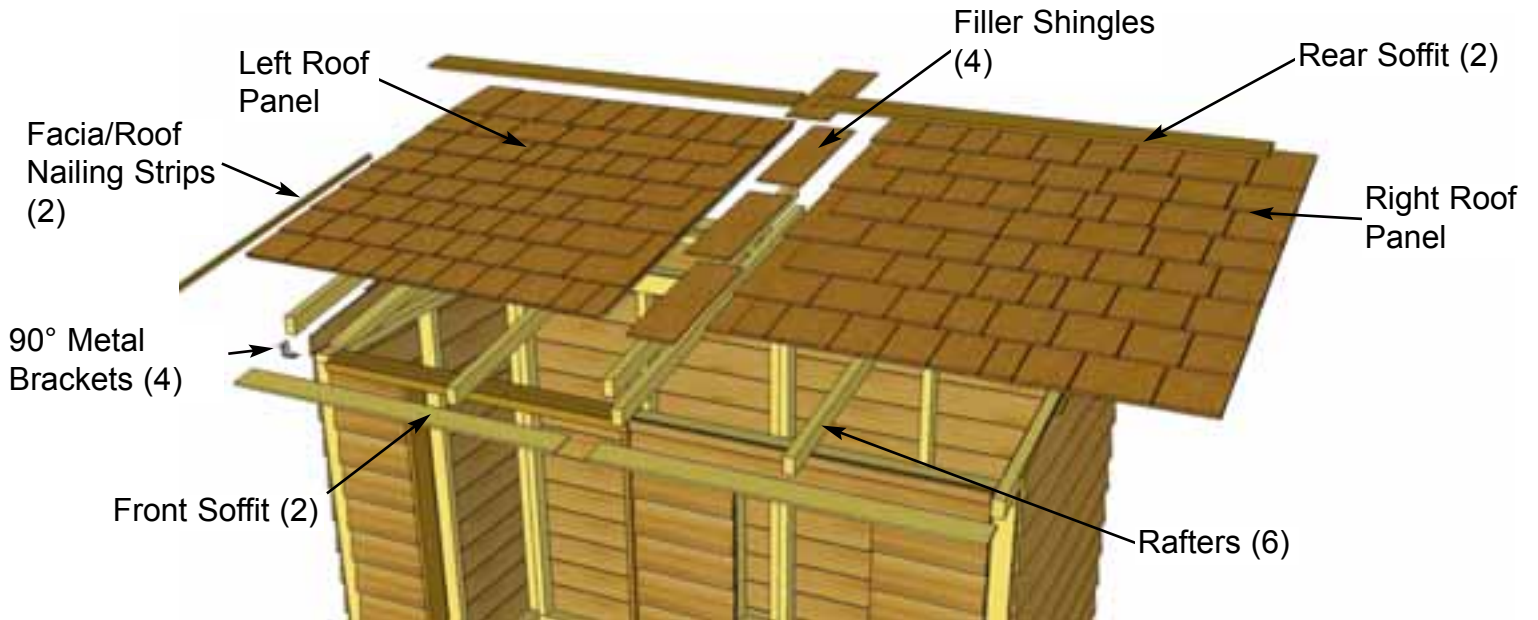

## GardenSaver

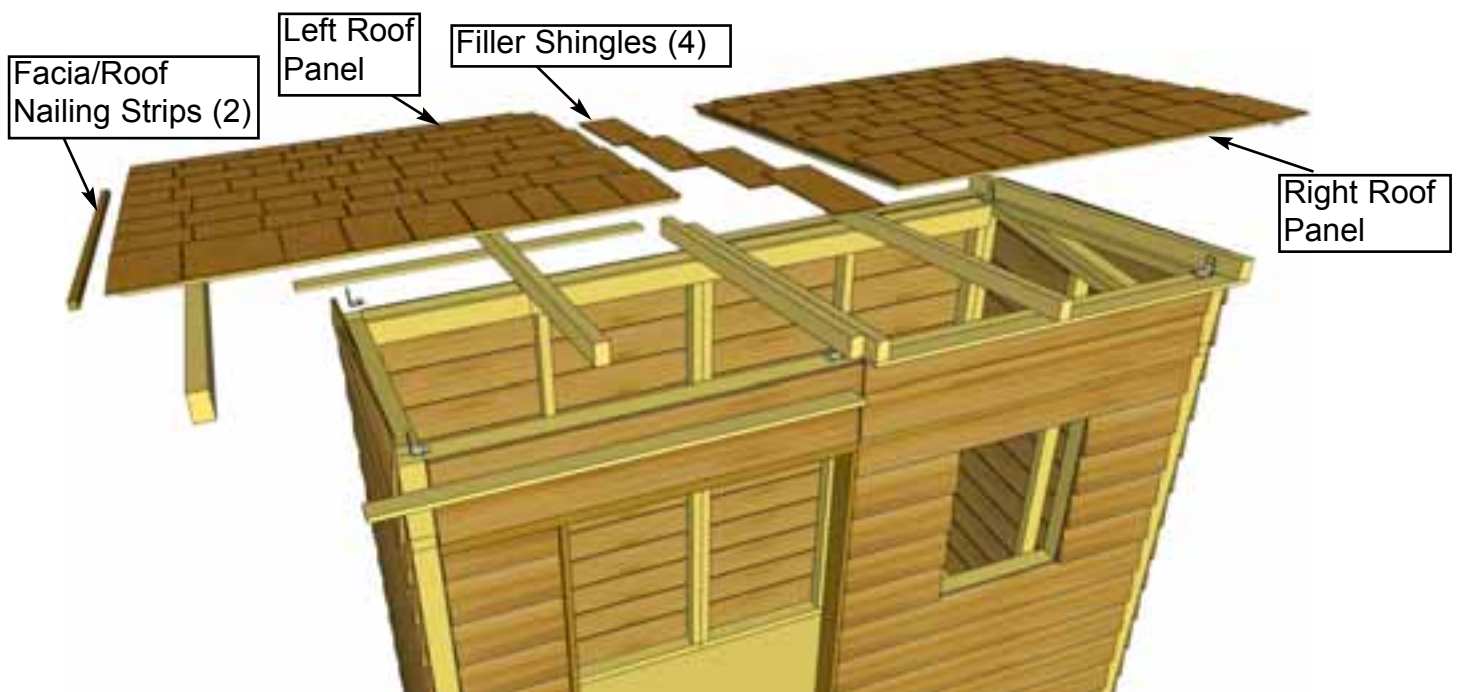

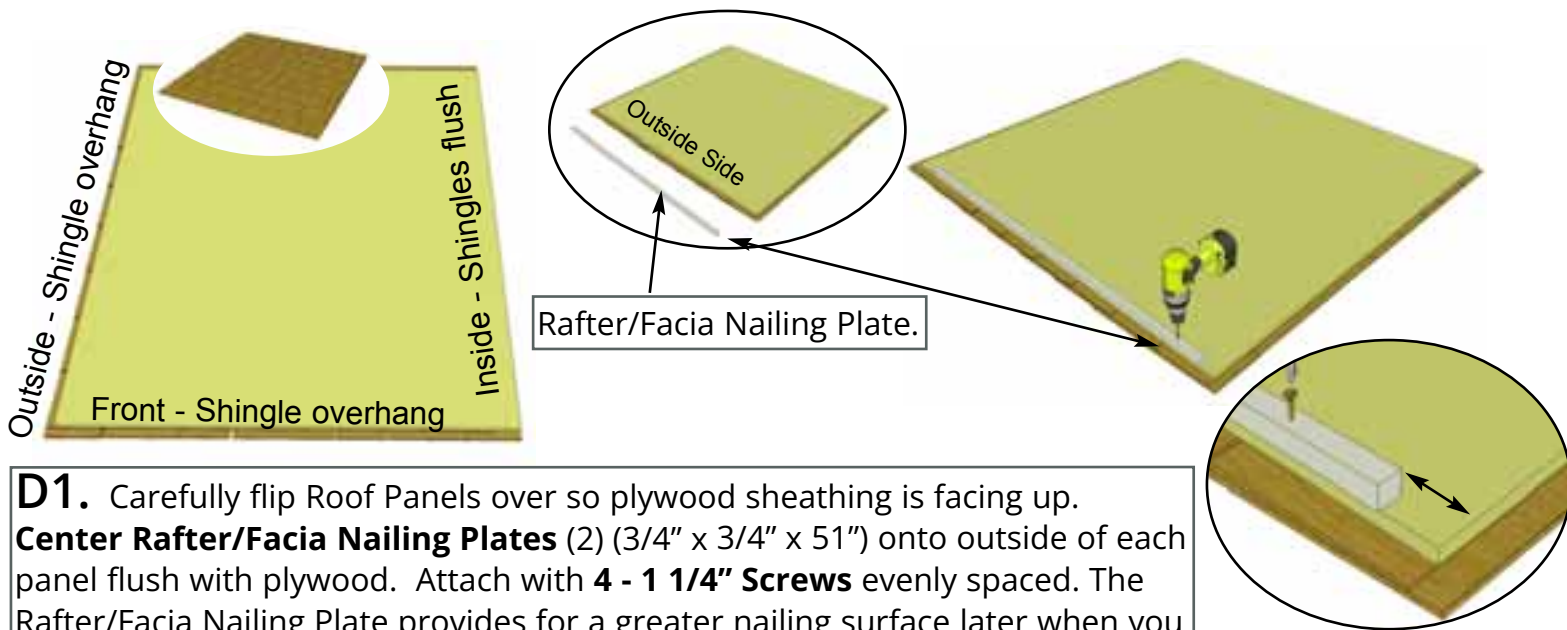

**D1.** Carefully flip Roof Panels over so plywood sheathing is facing up. **Center Rafter/Facia Nailing Plates** (2) (3/4" x 3/4" x 51") onto outside of each panel flush with plywood. Attach with **4 - 1 1/4" Screws** evenly spaced. The Rafter/Facia Nailing Plate provides for a greater nailing surface later when you attach side facia.

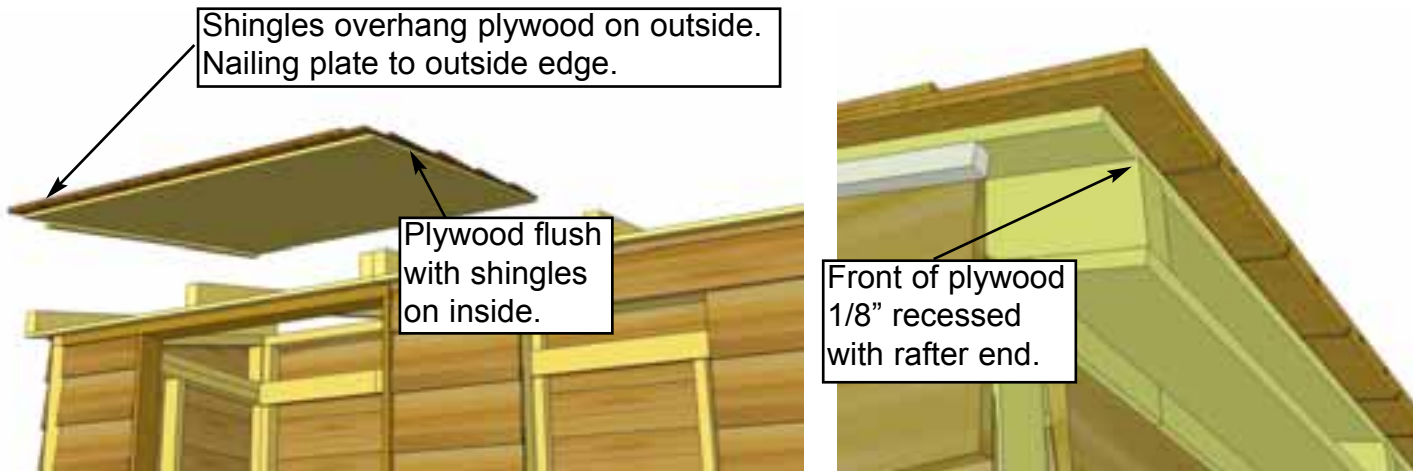

**D2.** Correctly orientate Left Side Roof Panel, with shingles overhanging plywood on the side of the shed and flush with plywood to the middle. Place on rafters with front of plywood just about flush with rafter ends but just slightly recessed. Doing so allows front facia to sit better.

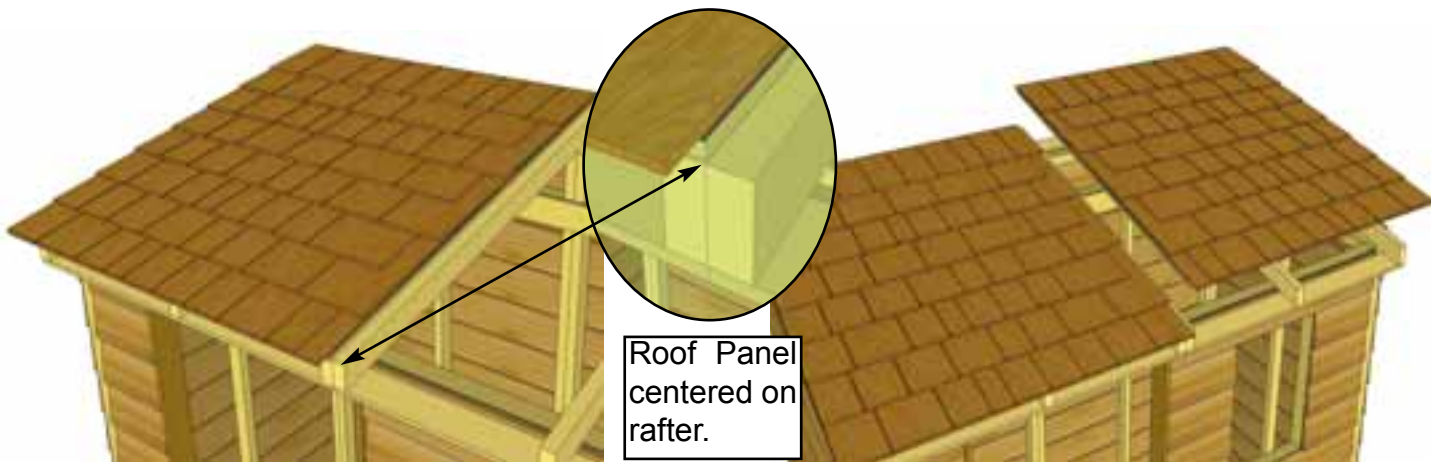

**D3.** For correct Roof Panel position, align panel so plywood sits evenly on Center Rafters. Complete both roof Panels.

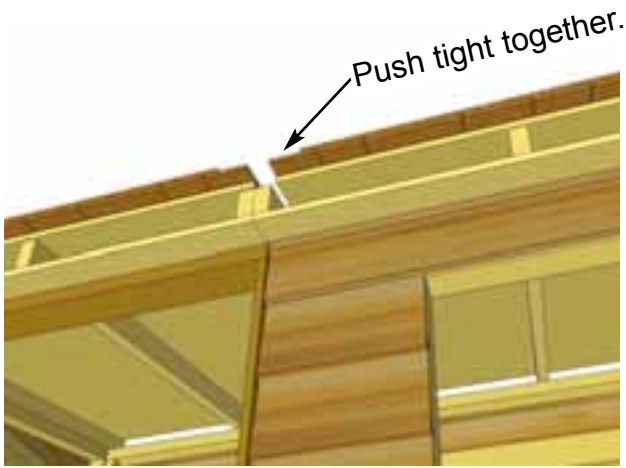

Screw Bottom Row of Shingles ONLY for now. Screw on angle away from shingle edge to prevent it from cracking.

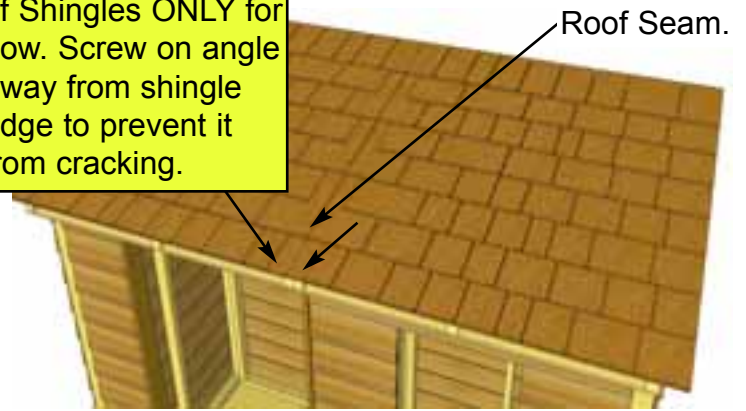

**D4.** With Roof Panels aligned, screw panels down to center rafters with 2 - 2 1/2" Screws in Bottom Row of Shingles Only (1 screw per panel).

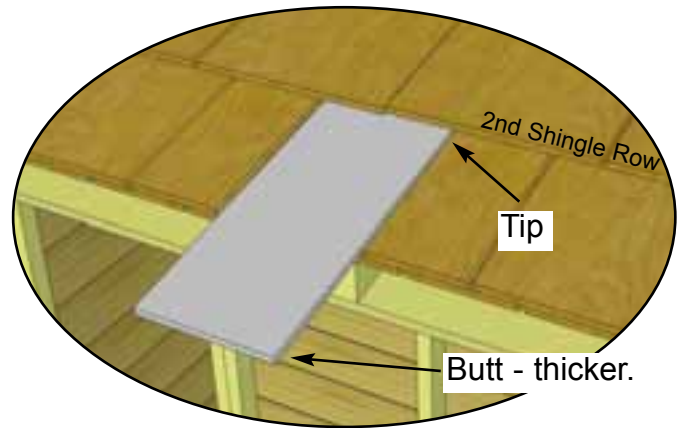
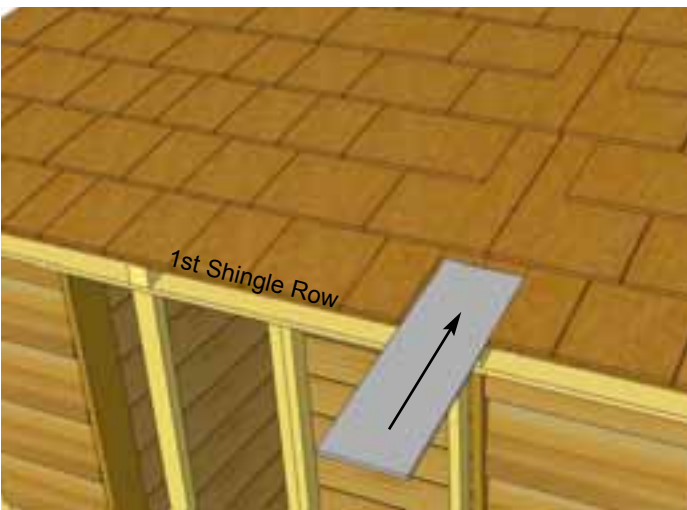

**D5.** To cover roof seam, slide one Filler Shingle (5 1/2" wide) up and underneath second shingle row. Push or bang filler carefully with a hammer until evenly spaced and butt is even with other 1st row of shingles.

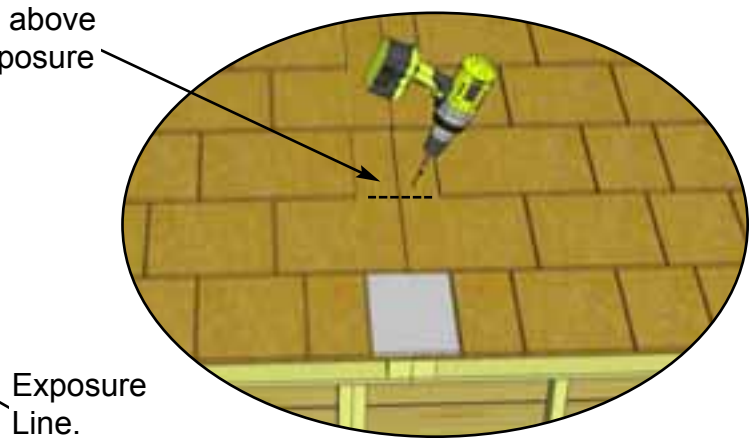
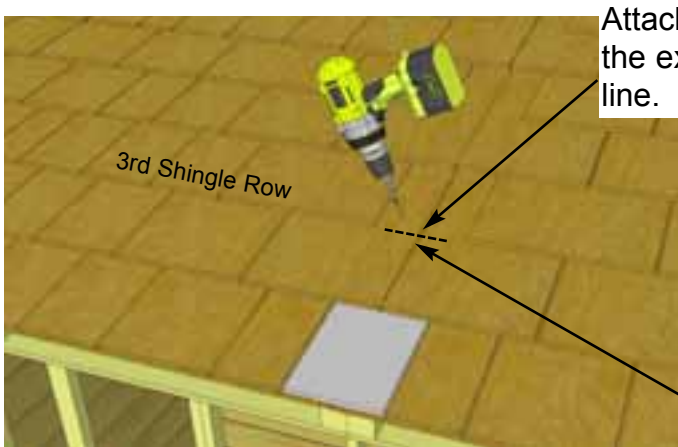

**D6.** Screw first filler shingle down to rafters using 1 - 2 1/2" Screw per panel (2 in total). Screw on slight angle and make sure to screw into rafter. Screw slightly above 3rd row of shingles (exposure line). This way, the screw will get covered up when you install your 2nd Filler Shingle and will prevent leaking.

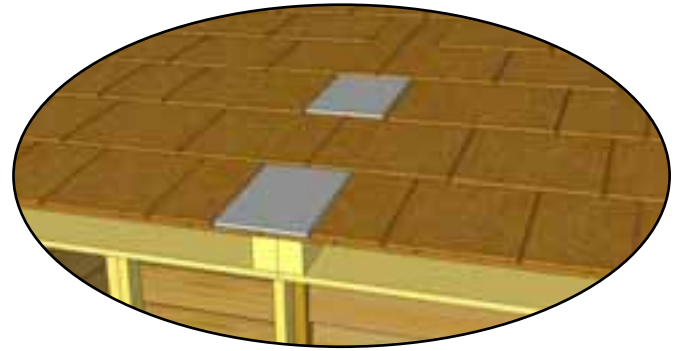
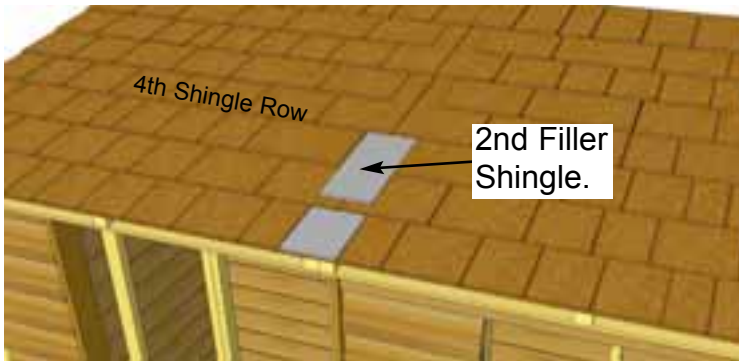

**D7.** Slide 2nd **Filler Shingle** up and underneath fourth shingle row. Follow **Steps D5 - D6** to align and attach.

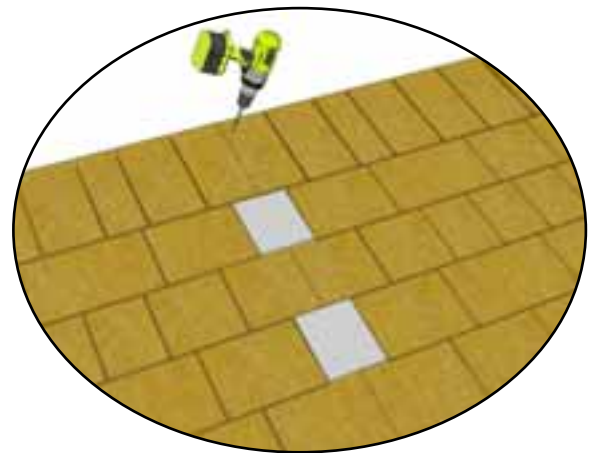
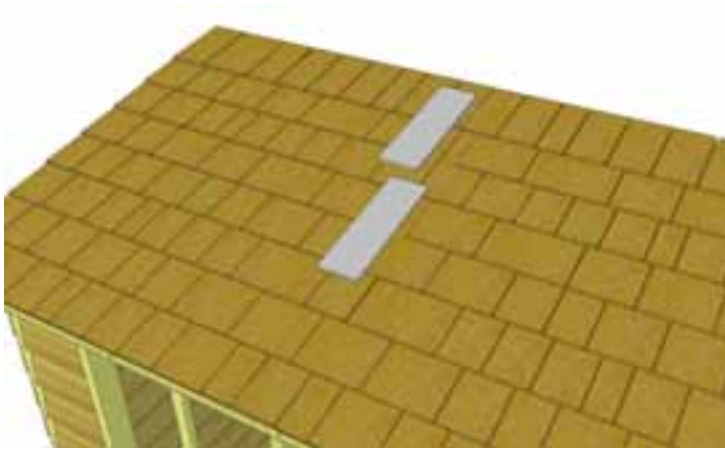

**D8.** Slide 3rd and 4th **Filler Shingles** up and underneath appropriate shingle rows and follow **Steps D5 - D6** to align and attach. On last filler, screws will get covered by Roof Ridge Board (4 1/2" wide).

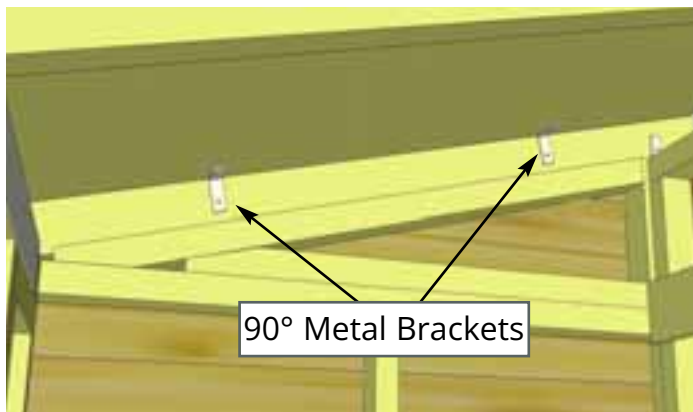

**D9.** Secure roof panels to walls at both ends by positioning **2 - 90° Metal Brackets** on plywood and outside rafters and securing with **2 - 1 1/4" Screws per bracket**. Complete both sides.

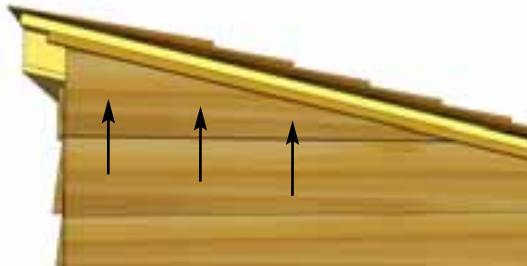
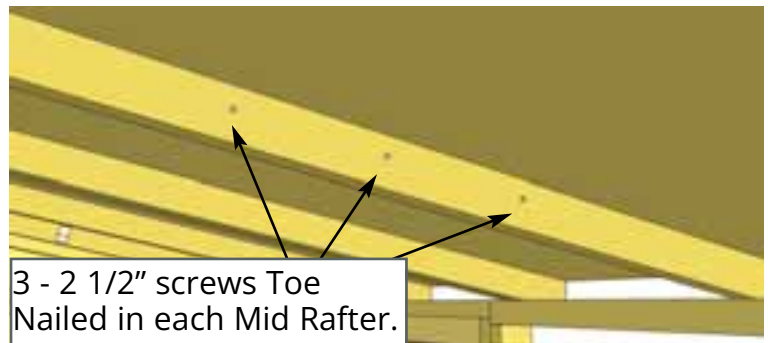
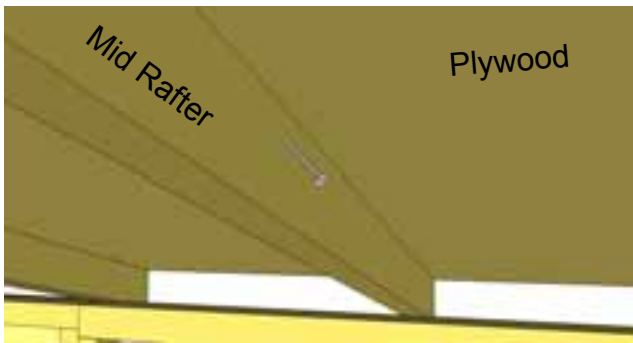

**D10.** To further secure roof panels from the inside, drill pilot holes on an angle in each panel's **Mid Rafter** (3 per Rafter). Using **3 - 2 1/2" Screws**, secure rafters to plywood. Note: from outside if possible, have a helper push roof panel down so plywood sits flush against rafter while securing. Locate **Top Siding Piece** for **Angled Wall Extender (L/R)**. Position top siding on wall extender and align as shown above. Attach with **3 - 1 1/2" Finishing Nails** to top wall framing. There are left/right top siding pieces. Use rough surface side out.

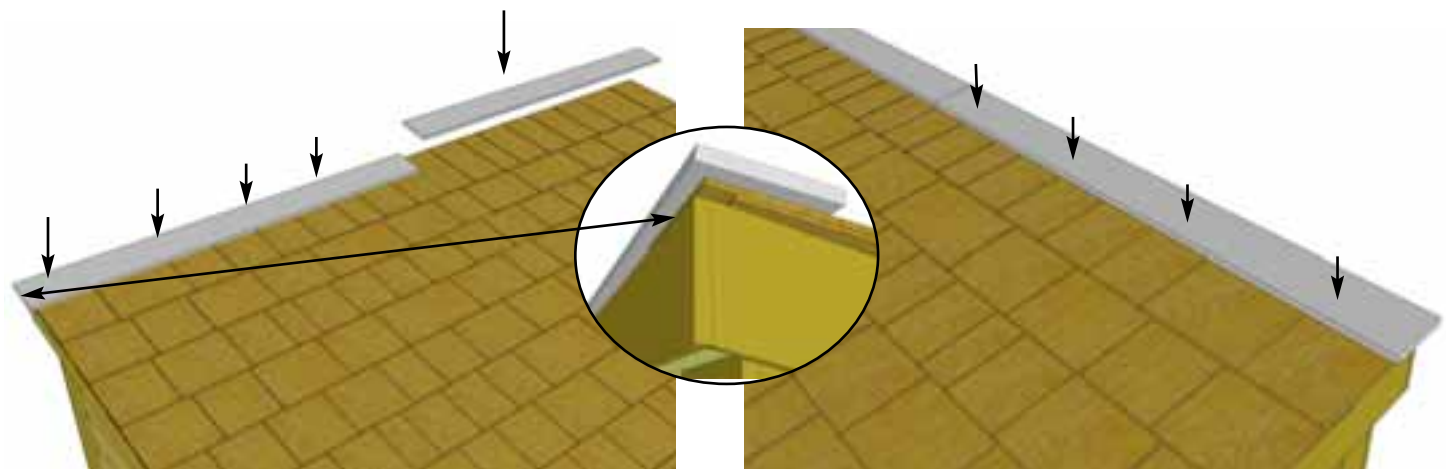

**D11.** Position **first Roof Ridge Board** (1/2" x 4 1/2" x 51 5/8") at the rear of roof to cap off shingles and fascia. Ridge Boards should meet on seam of roof panels. When aligned correctly, attach with **4 - 1 1/2" Finishing Nails** per piece.

# D. Roof Section - Metal

Exploded view of all parts necessary to complete the Rafter and Roof Section. Identify all parts prior to starting.

Roof Section will be installed the same way for both GardenSaver and SpaceSaver. When following assembly steps keep your desired roof slope in mind relative to the door.

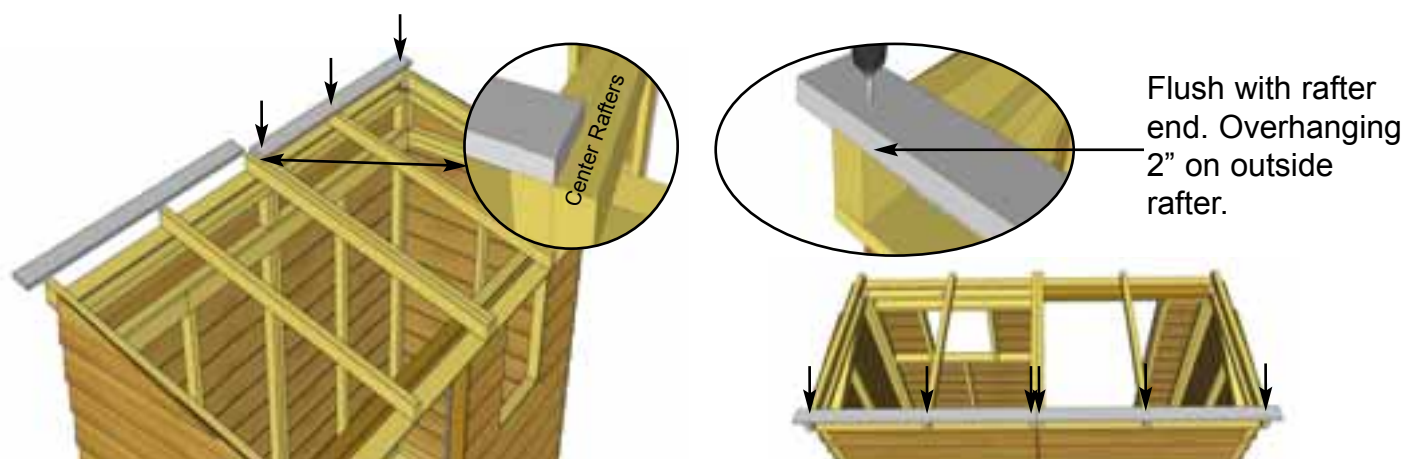
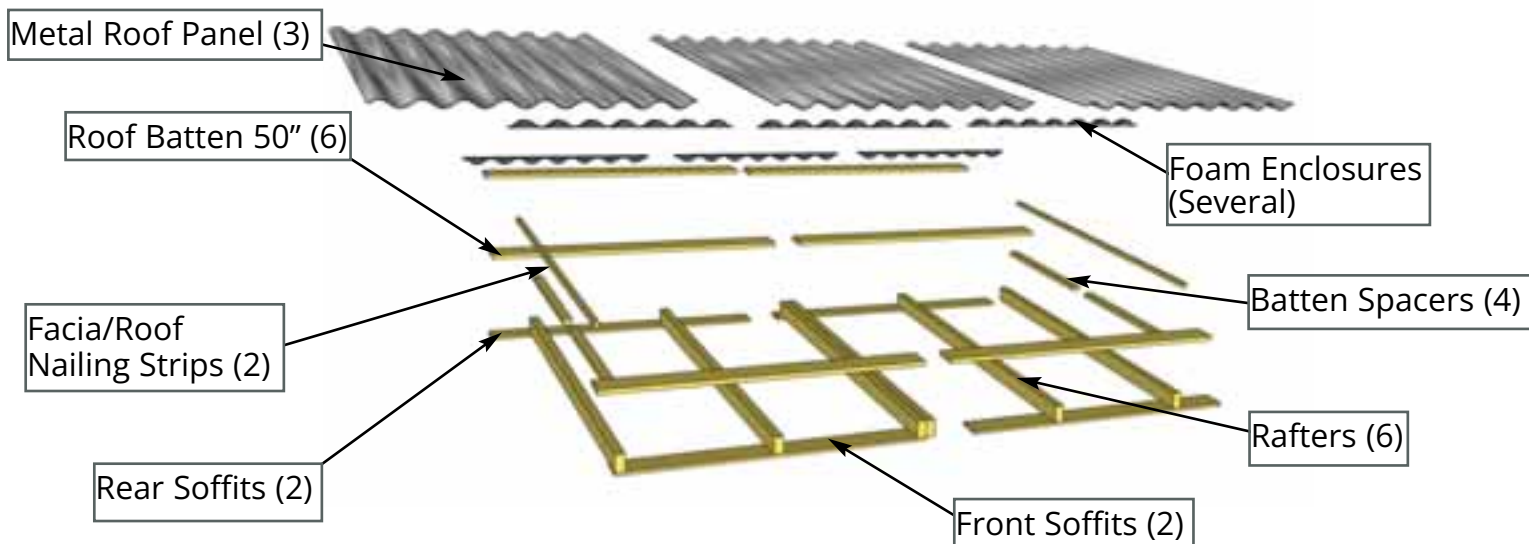

**Important:** Pre-drill pilot hole with 1/8" drill bit first to prevent rafter from splitting.

**D1.** Position first row of **Roof Battens** (3/4" thick x 3 1/2" wide x 50" long x 2 ) on front of roof rafters. Place 1/8" back from end of rafter. Batten will sit evenly on center rafters overhanging 2" on the outside rafters. Attach batten with **1 - 1 1/4" Screw** per each rafter. Pre-drill with 1/8" drill bit first to prevent end from splitting. Complete attachments of both 50" long roof battens.

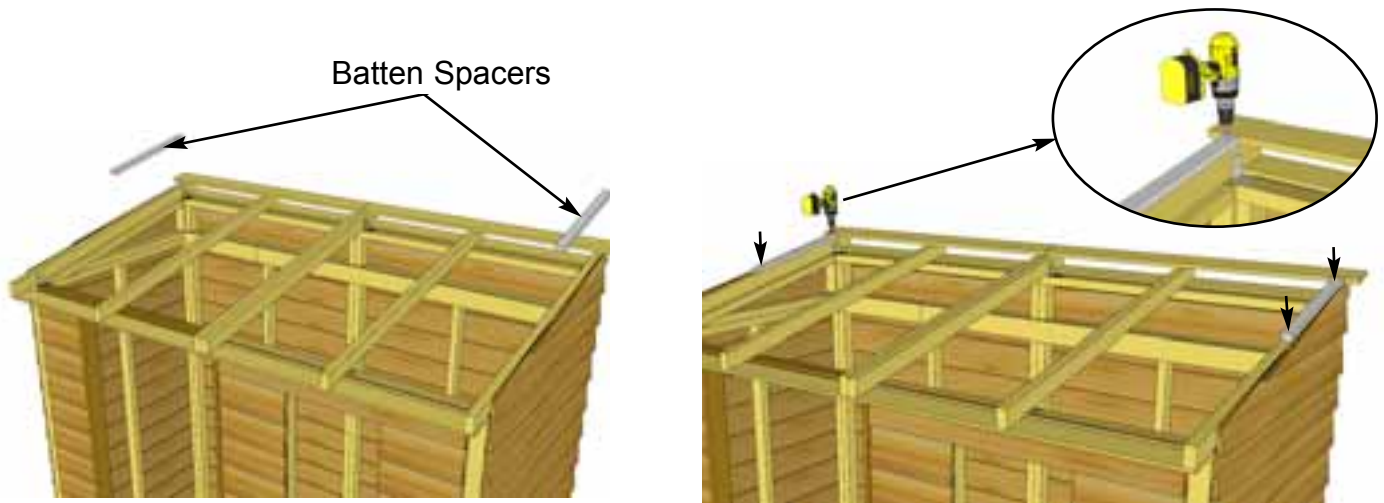

**Important:** Pre-drill pilot hole with 1/8" drill bit first to prevent Batten Spacer from splitting.

**D2.** Place **Batten Spacers** (2 pcs x 3/4" x 1 1/2" x 21 1/2") above each end of the attached Batten, lengthwise along outside Rafter. Ensure Batten Spacer is tight with Batten. Attach Batten Spacer to Rafter using **2 - 1/4" Screws** (4 total)

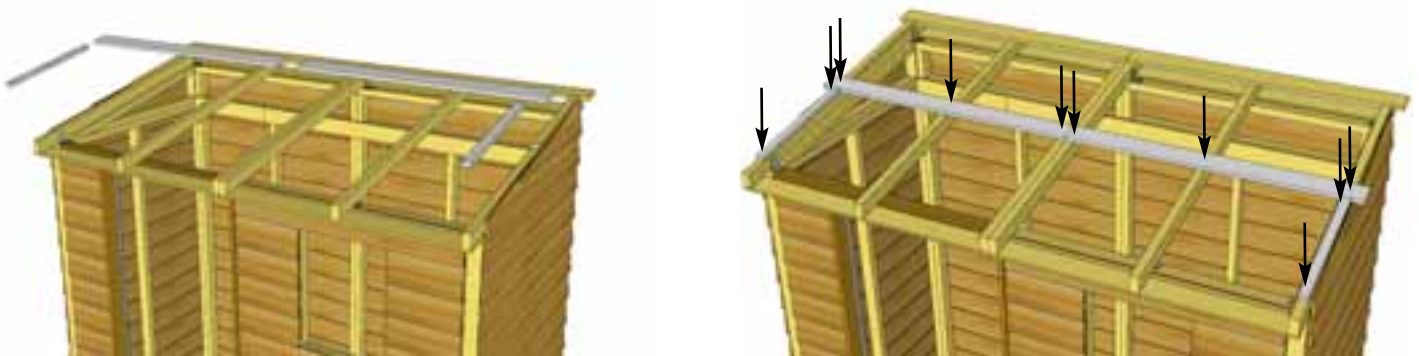

**D3.** Locate middle row of **Roof Battens** ( 2 pcs x 3/4" thick x 3 1/2" wide x 50" long) and attach flush with previously attached **Batten Spacers** as per the same method as **Step D1**. Attach a second row of **Batten Spacers** flush with the bottom edge of this middle **Batten** row via the same method as **Step D2**.

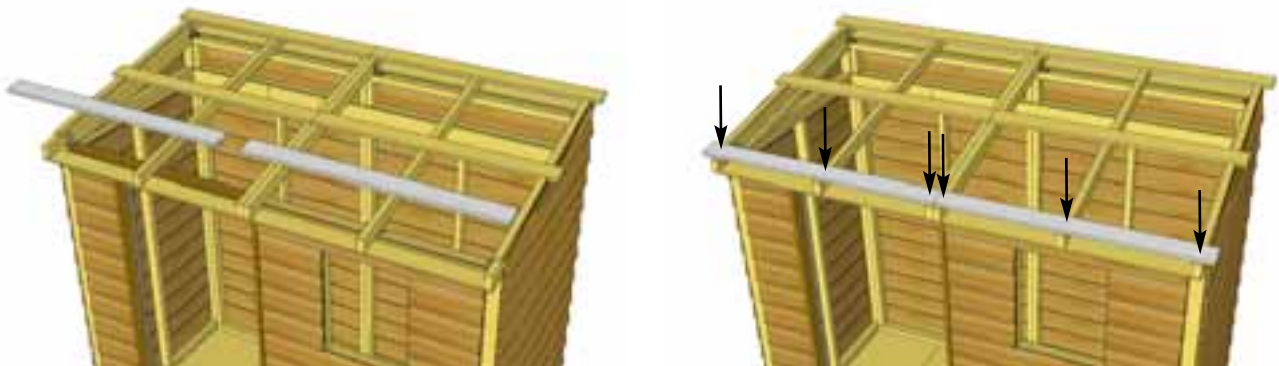

**D4.** Locate lower row of **Roof Battens** ( 2 pcs x 3/4" thick x 3 1/2" wide x 50" long) and attach flush with previously attached **Batten Spacers** via the same method as **Step D1**, using a total of **6 - 1 1/4" Screws**.

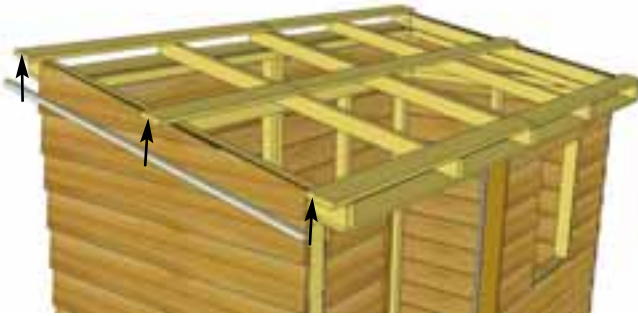

**D5.** Center **Facia Nailing Cleats** ( 2 pcs x 3/4" x 3/4" x 51") underneath outside of each batten. Attach with 3 - 1 1/4" screws evenly spaced into the batten. The **Facia Nailing Cleat** provides a greater surface later when you attach side facia.

Metal Roof Hangers will temporarily help keep Metal Roof Panels in place before they are fastened.

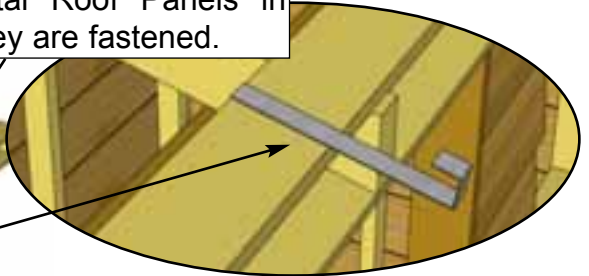
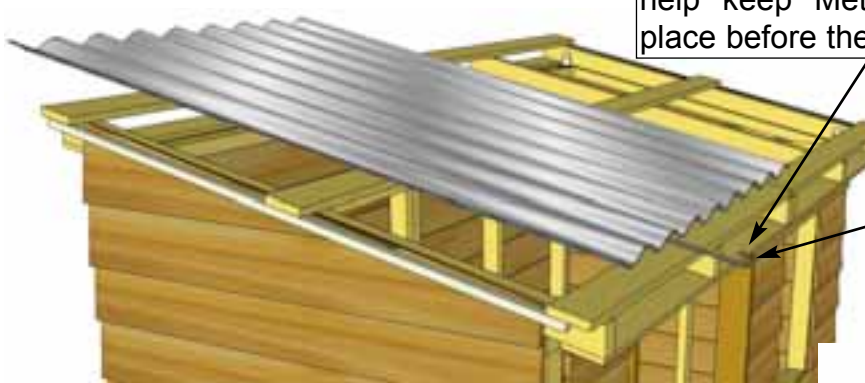

**D6.** Locate all **Metal Roof Hangers** (3pcs) and **Metal Roof Panels** (3pcs - 39" wide x 58 1/2" long - Identical). To temporarily help hold the **Metal Roof Panel** in place, hook a **Metal Roof Hanger** onto the lower **Batten** approximately where the center of the first **Panel** will be. Place the first **Metal Roof Panel** on **Battens**. Do not fasten **Panels** down until **Steps D10 & D12**. Place other two **Metal Roof Panels** with **Hangers** the same way.

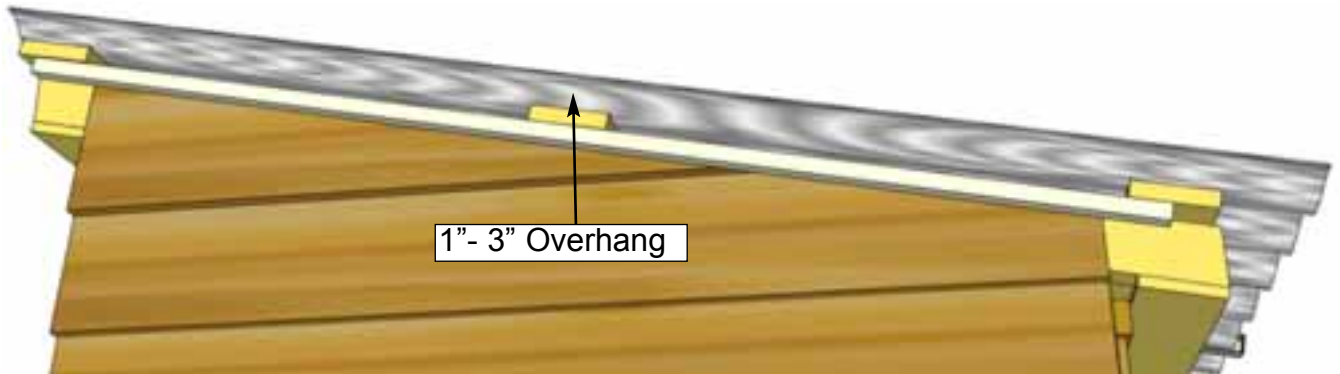

**D7.** Overhang the **Metal Roof Panels** past the **Battens** on the sides by approximately 1" - 3", depending on your personal preference. The overhang on front and back will be set by the **Metal Roof Hangers**, but should be approximately 1" on the back and approximately 4" on the front.

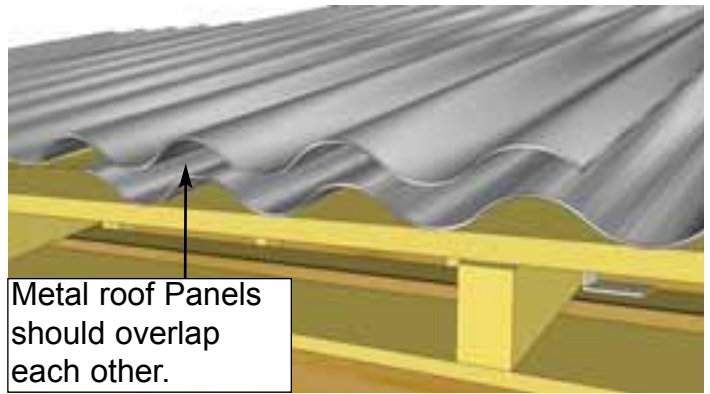
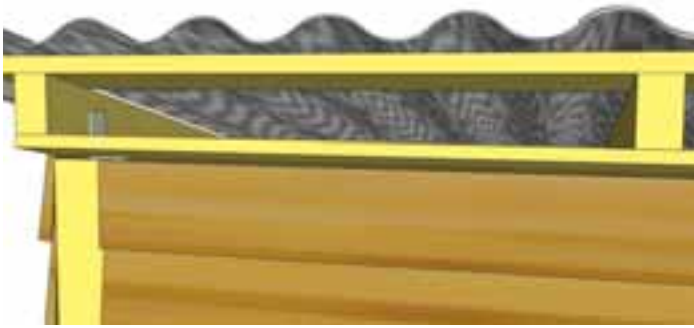

**D8.** Adjust the position of remaining **Metal Roof Panels** on **Battens** as per **Step D7**. Overlap **Metal Roof Panels** to achieve the desired overall width. Overall width past the end of **Battens** can vary from 1" - 3", depending on your personal preference.



**D9.** Once Metal Roof is spaced correctly from side to side and top-to-bottom, lift panels up and run a bead of caulking down the overlapping seams of each panel to seal the joints. You will likely need assistance from a helper in this step.

Attach middle row before removing Metal Roof Hangers. Screw into center of Battens.

**Note:** Metal Roof Hangers will need to be removed in **Step**

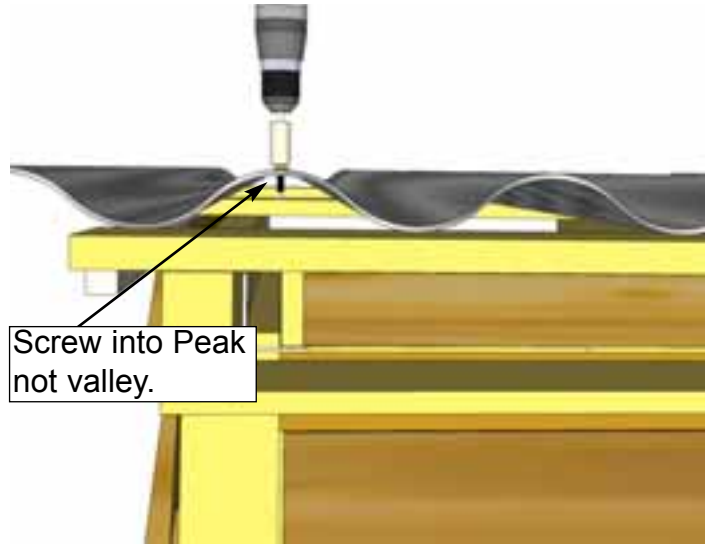
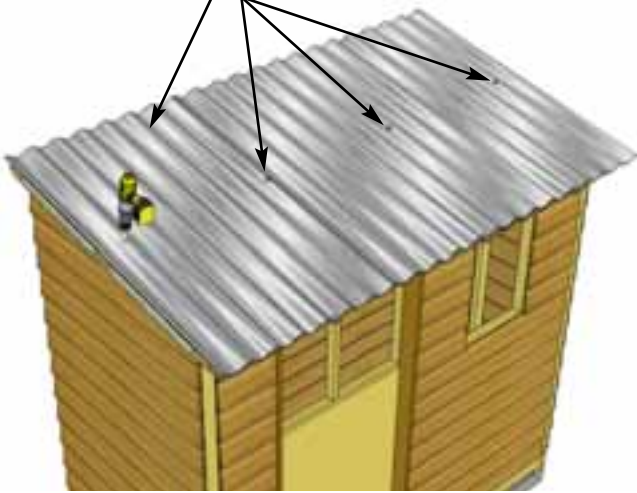

**D10.** Using 4 - 1 1/2" Metal Screws and 1/4" Nut Driver (included), secure Metal Roof Panels down to the middle Batten row. Metal screw is self-tapping, screw into the center of Battens. Eight more 1 1/2" Metal Screws will be required to further secure Metal Roof Panels and to complete Metal Ridge Caps in later steps.

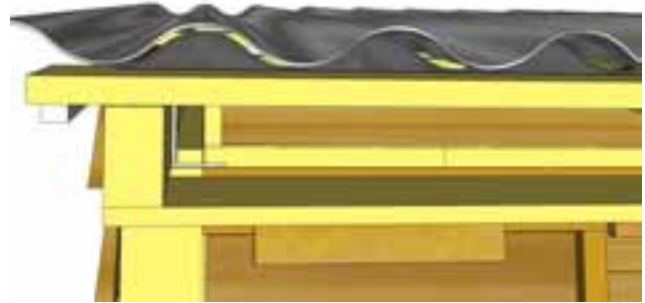
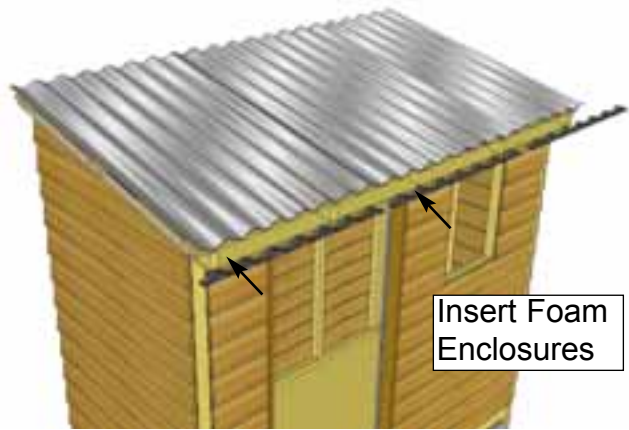
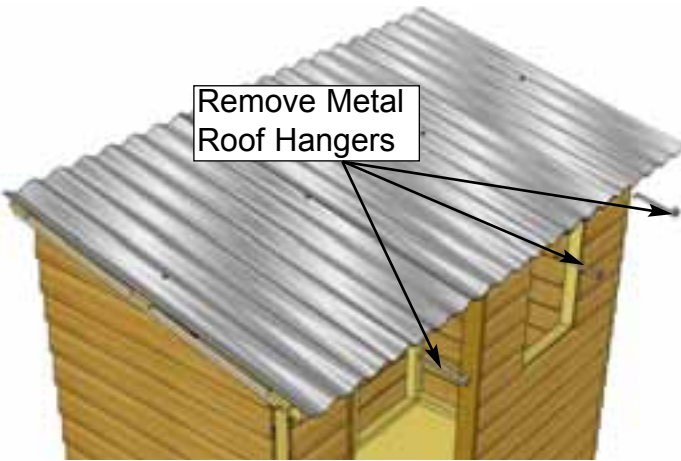

**D11.** Before fully fastening Metal Roof Panels down, remove the Metal Roof Hangers and insert 3 pieces of Foam Enclosures between Metal Roof Panels and Battens at the front/bottom. Enclosures may need to be snipped down in length to fit. Enclosures will prevent moisture and unwanted bugs, etc from entering your shed from here.

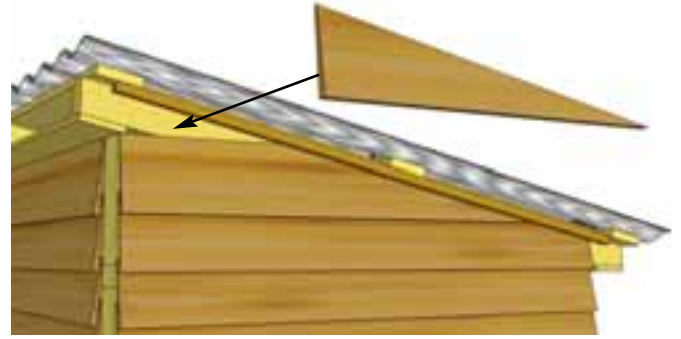
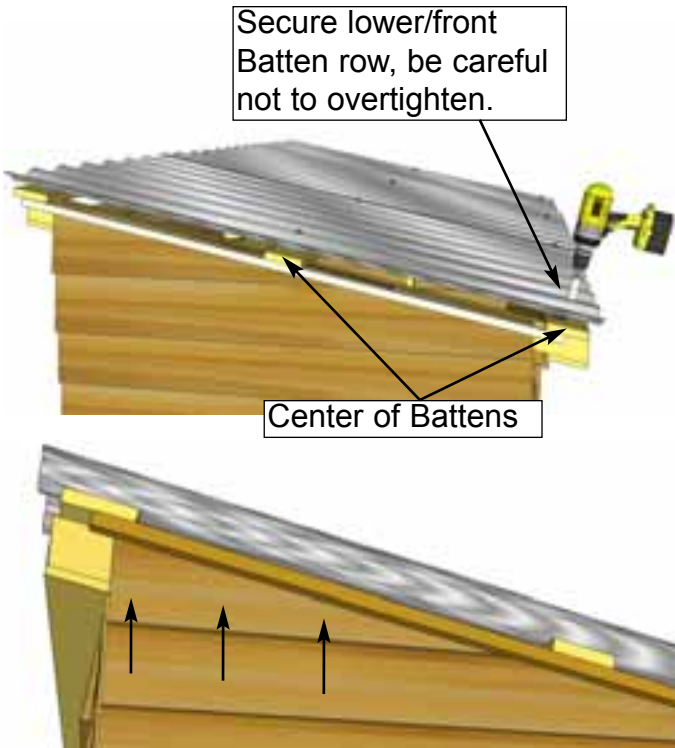

**D12.** Using 4 - 1 1/2" Metal Screws and 1/4" Nut Driver, secure Metal Roof Panels down to lower/front Batten row. Do not overtighten! Locate Top Siding Piece for Angled Wall Extender (L/R). Position top siding on wall extender and align as shown above. Attach with 3 - 1 1/2" Finishing Nails to top wall framing. There are left/right top siding pieces. Use rough surface side out.

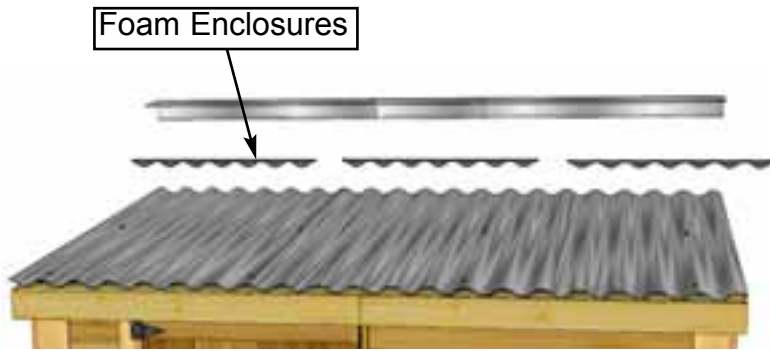

**D13.** Locate Foam Enclosure for Metal Roof and place 3 pieces on front side of roof to go underneath the drip cap in Step D14. Enclosures may need to be snipped down in length to fit.



**D14.** Before Place Metal Drip Caps (2 pcs - 60" long) on top of metal roof in the rear. Evenly spaced from side-to-side allowing caps to overlap each other. Overhang the cap approximately 1" past each end. When drip cap is correctly positioned, secure with 4 - 1 1/2" Metal Screws using 1/4" nut driver as per Step D12. Screw into top batten. Do not overtighten.

# D. Roof Section - Plywood

Exploded view of all parts necessary to complete the Rafter and Roof Section. Identify all parts prior to starting.

Roof Section will be installed the same way for both GardenSaver and SpaceSaver. When following assembly steps keep your desired roof slope in mind relative to the door.

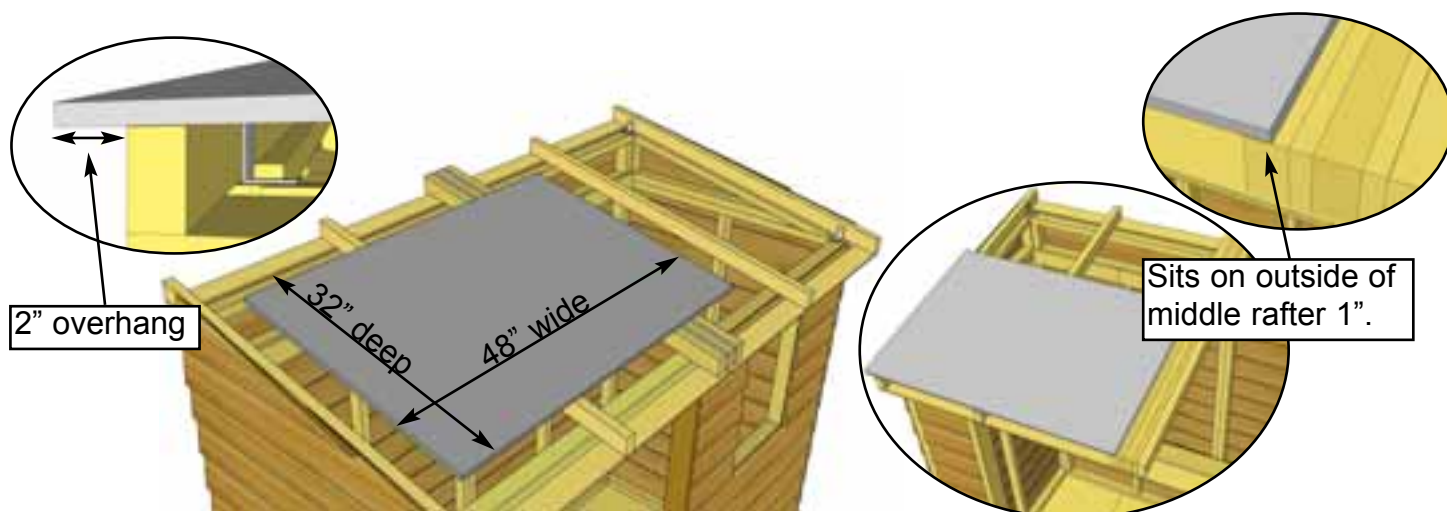
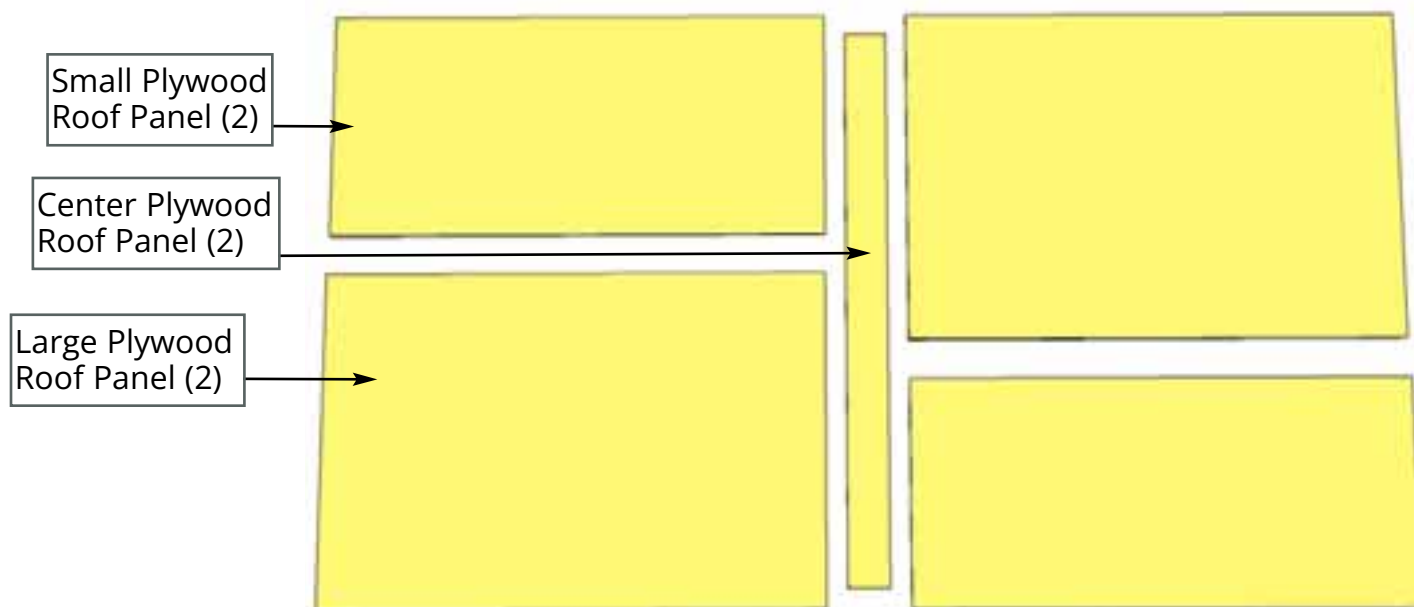

**D1.** There are 3 different plywood roof panel sizes required to complete roof.

48" wide x 32" long x 2 pcs. - **Long Plywood Roof Panel**

48" wide x 21 3/4" long x 2 pcs. - **Short Plywood Roof Panel**

4" wide x 53 3/4" long x 1 pc. - **Center Plywood Roof Panel**

Starting with rear left corner, position **Long Plywood Roof Panel 9** (48" wide x 32" long) rafters. Plywood will overhang outside rafter by 2". In the front, plywood will be recessed 1/8" back from rafter end.

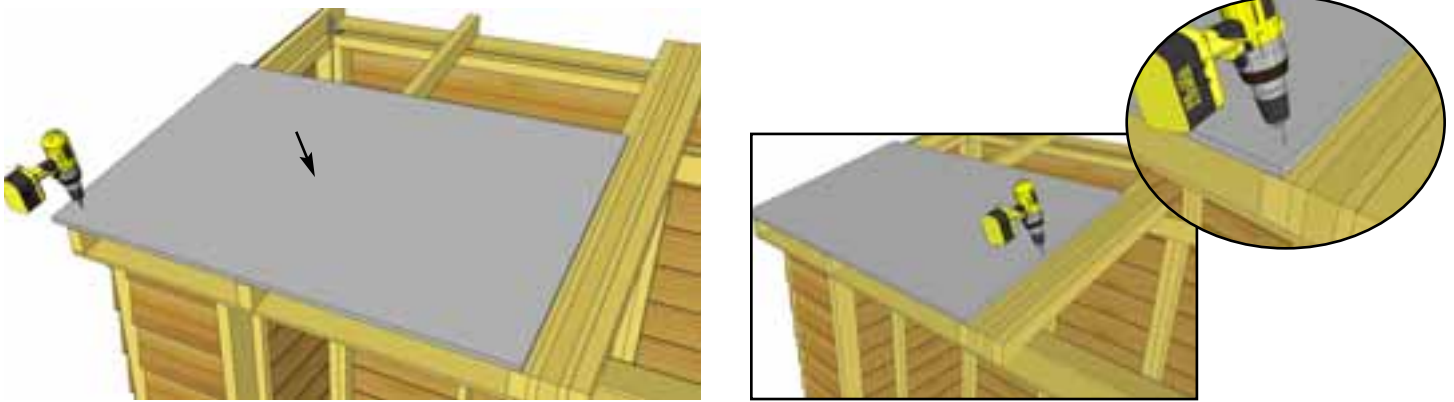

**Important:** Pre-drill pilot holes through roof panel and rafters with 1/8" bit to prevent splitting.

**D2.** With panels positioned correctly, attach to rafters with 12 - 1 1/4" Screws. Before attaching screws pre-drill pilot hole with 1/8" bit to prevent rafters from splitting. Start screws 1" away from edge of roof panel, then space screws approximately 10" apart. Be sure to attach screws into center of rafters as shown above.

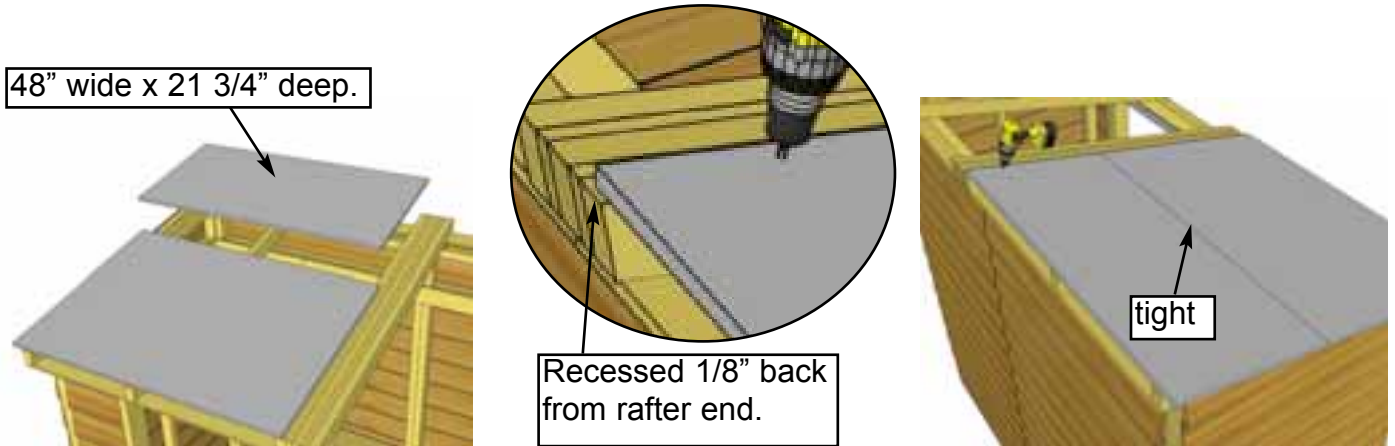

**D3.** Locate **Short Plywood Roof Panel** (48" wide x 21 3/4" long) and position on rafters tight against large roof panel. Position with same side overhang. Once positioned attach with 9 - 1 1/4" Screws. Pre-drill pilot holes and drill into center of rafter. Start screws 1" from edge of roof panel and space approximately 10" apart.

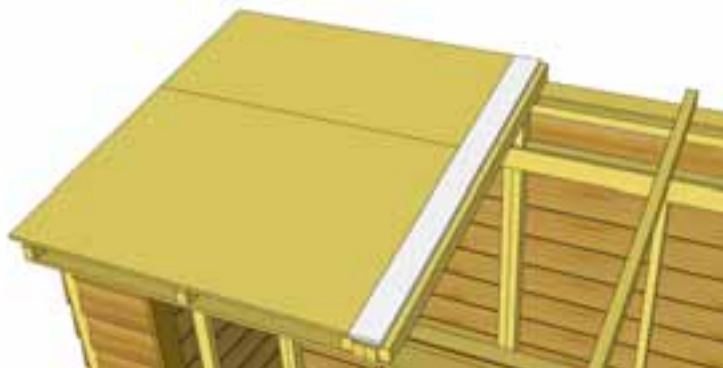

**D4.** Locate **Center Plywood Roof Panel**. Place Center Roof Panel on rafters tight to previous two panels. Secure center roof panel with 6 - 1 1/4" Screws into center rafter as per Steps D2-D3.

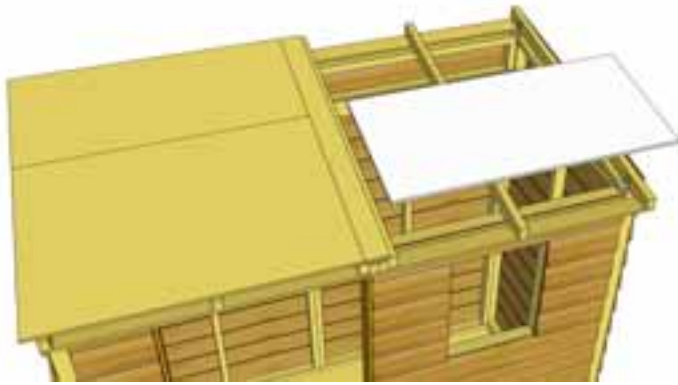

**D5.** Locate second **Small Plywood Roof Panel**. Position on rafters on rear of shed. Attach to rafters with 9 - 1 1/4" Screws as per Step D3.

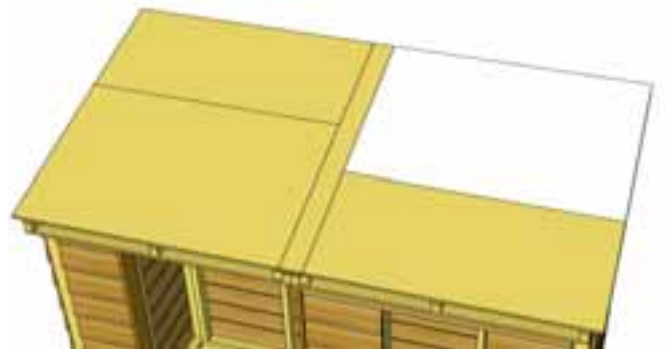
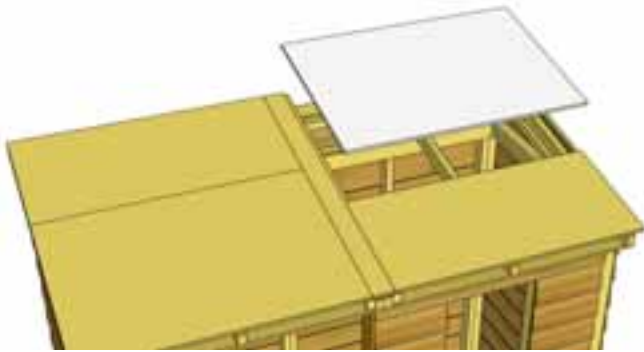

**D6.** Locate second **Large Plywood Roof Panel**. Position on rafters on rear of shed. Attach to rafters with 12 - 1 1/4" Screws as per Step D2.

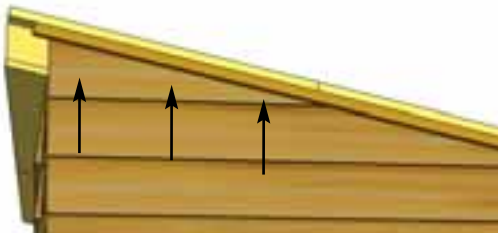
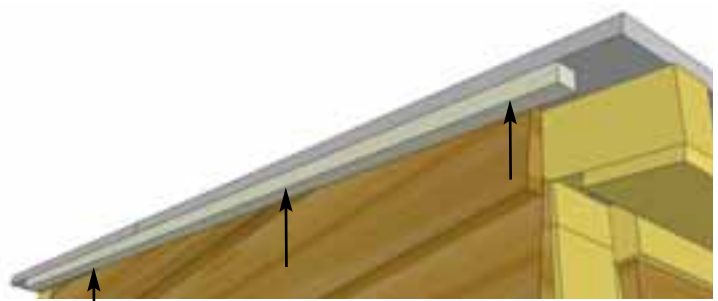

**D7.** Center **Rafter/Facia Nailing Plates** (2) (3/4" x 3/4" x 51") onto outside of each plywood panel flush on edge. Attach with 4 - 1 1/4" Screws evenly spaced. The Rafter/Facia Nailing Plate provides for a greater nailing surface later when you attach side facia. Locate **Top Siding Piece for Angled Wall Extender (L/R)**. Position top siding on wall extender and align as shown above. Attach with 3 - 1 1/2" Finishing Nails to top wall framing. There are left/right top siding pieces. Use rough surface side out.

# E. Miscellaneous Section

Exploded view of all parts necessary to complete the Skirting, Trim, Facia and Miscellaneous Pieces. Identify all parts prior to starting.

(Not Shown: Door Stops, Flange, Threshold, Rear Trim, Horizontal Door Trim and Roofing Felt)

Misc. Section will be installed the same way for both GardenSaver and SpaceSaver. When following assembly steps keep your desired roof slope in mind relative to the door.

## SpaceSaver

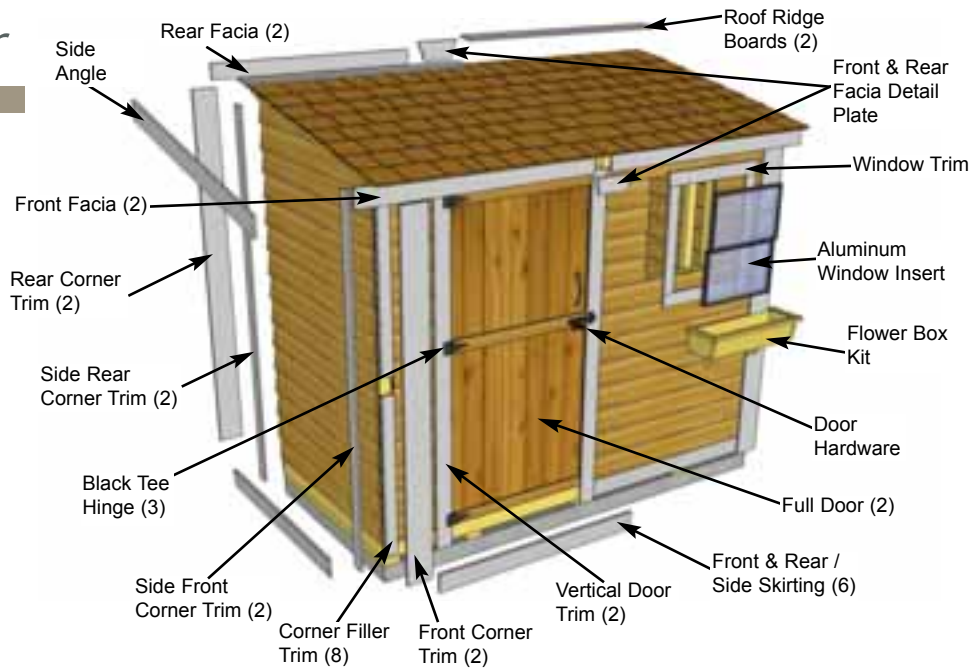

## GardenSaver

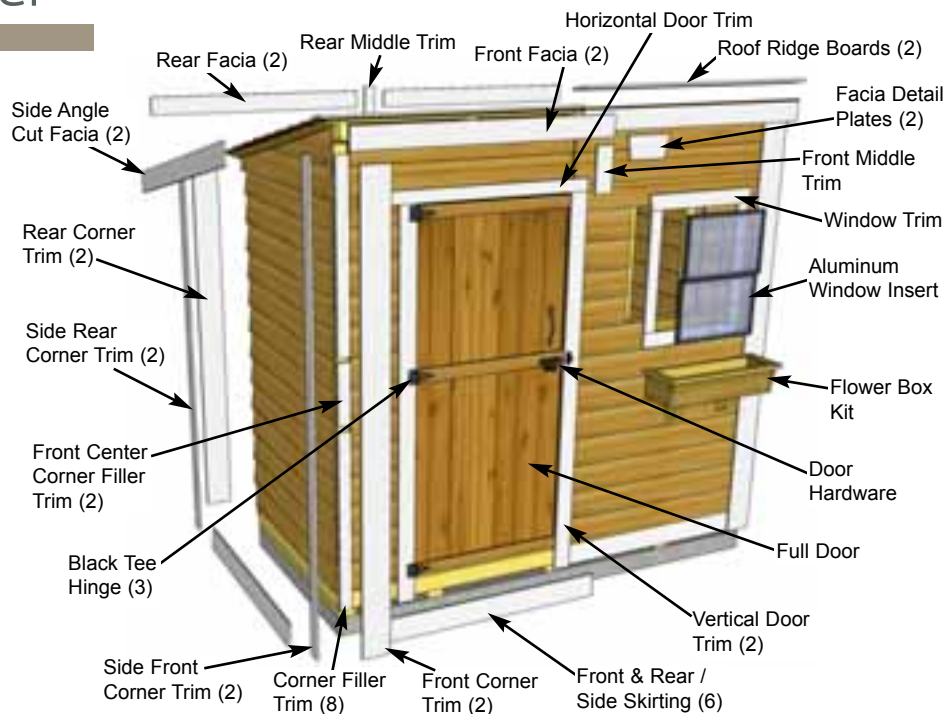

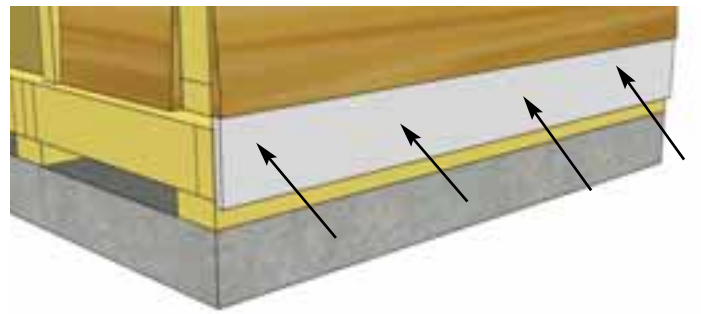
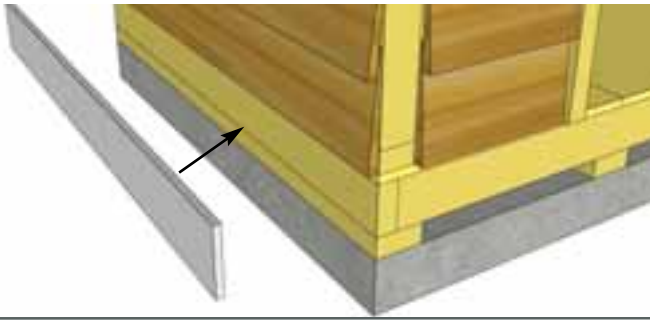

**E1.** Attach **Bottom Skirting** (1/2" x 4 1/2" x 45 1/4"l) around the base of the shed. Skirting will hide floor framing. Start with side skirting pieces first and attach with 4 - 1 1/2" Finishing Nails per piece.

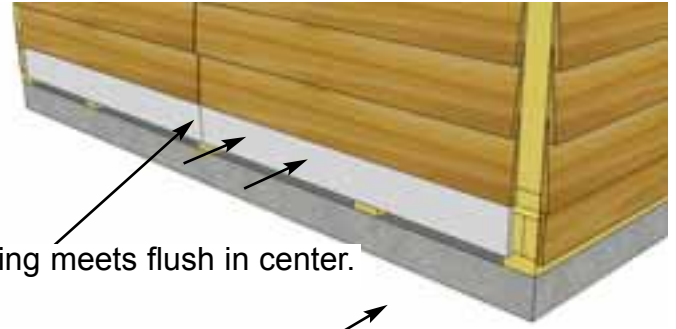
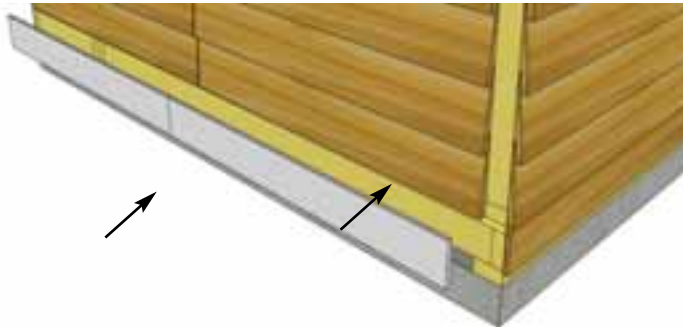

Skirting meets flush in center.

**E2.** Rear skirting pieces will meet together in the center. Secure with 4 - 1 1/2" Finishing Nails per piece.

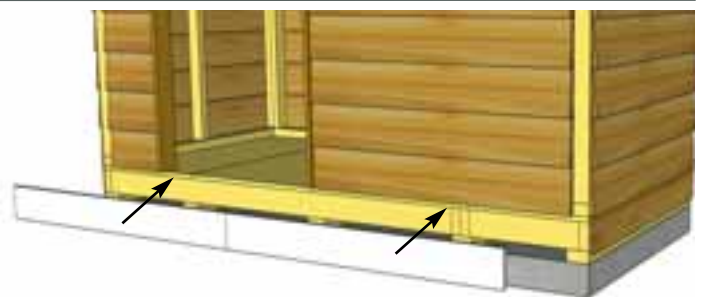
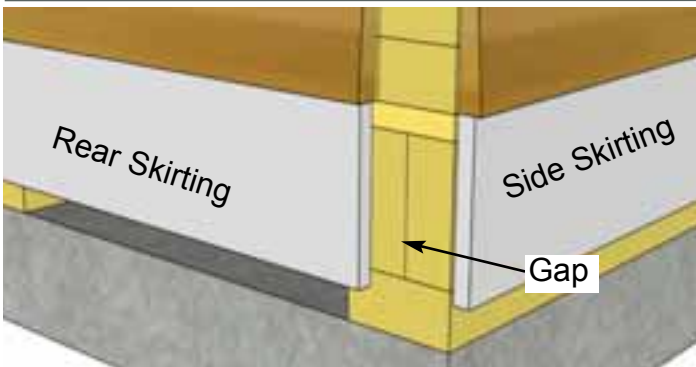

**E3.** Gaps on outside will be covered by Corner Trim pieces later. Complete front and side skirting attachments.

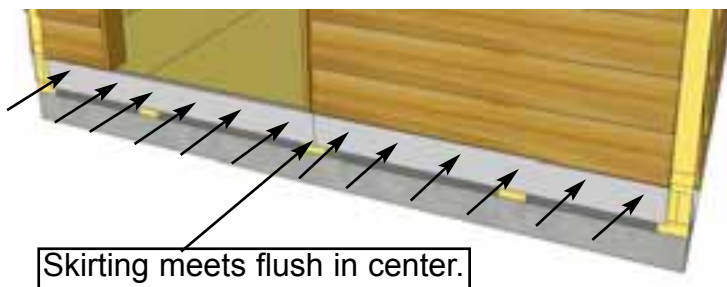

**E4.** Use 6 - 1 1/2" Finishing Nails on front skirting piece where doors will be installed. This adds extra support to a high traffic area.



**E5.** Check the wall seams for visible gaps prior to attaching filler trim and apply caulk where needed. Caulking gaps will help prevent moisture from entering and will help the longevity of your shed. **Caulking not included in kit.**

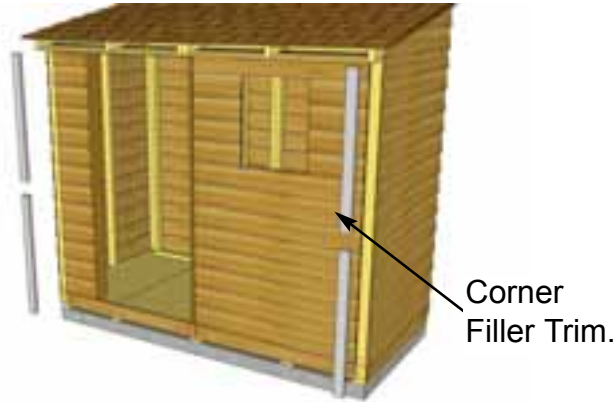

**E6.** Locate **Corner Filler Trims** (8 - 7/8" x 2 1/2" x 36"). Fillers are essentially nailing strips and will not be visible once additional corner trims are attached later.

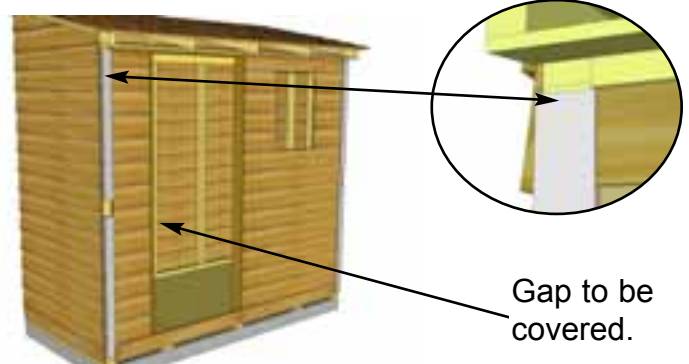
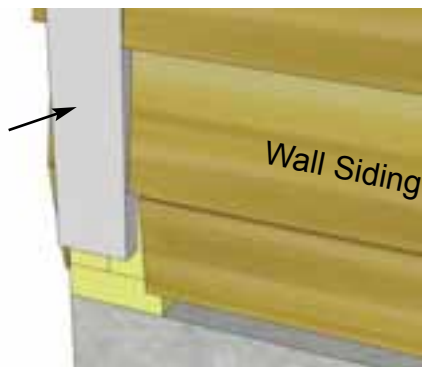

**E7.** Attach **Corner Filler Trims** where gaps exist in front corners (2 per side). Hammer with 8 - 1 1/2" Finishing Nails.

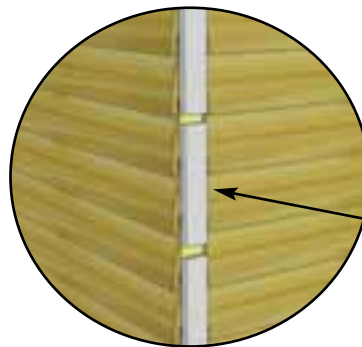

**E8.** Position and attach **Corner Filler Trims** in the rear as per **Step E7**. There is an additional 10" long **Center Corner Filler Trim** that you will need to center and attach as well using 2 - 1 1/2" Nails.

**E9.** To completely trim out front corners, locate a **Low Side Corner Trim** (1/2" x 2 1/2" x 80") and a **Low Corner Trim** (1/2" x 5 1/2" x 79").

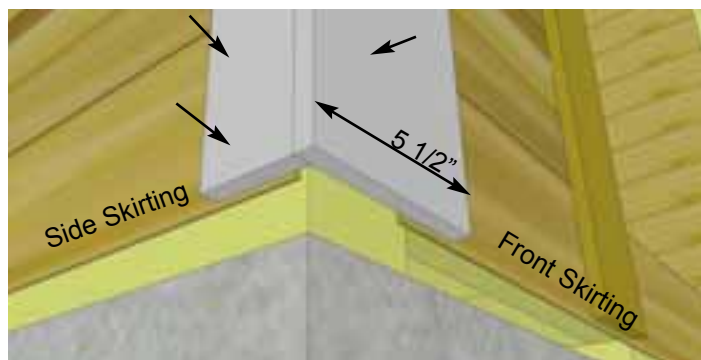
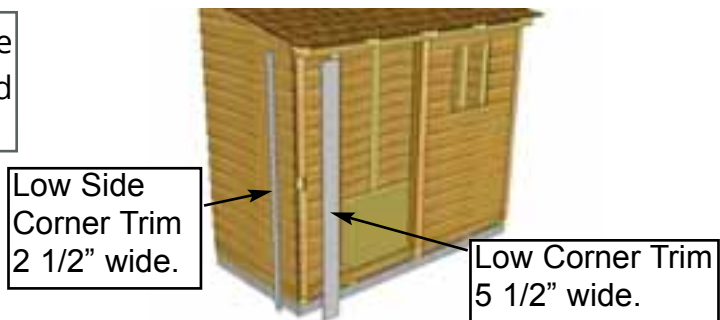

**E10.** Place both trims in front corner and align as illustrated. Do a dry run prior to attaching to achieve best fit. Start with 5 1/2" wide Front Corner Trim and align tight underneath soffit to determine vertical height. Attach with **8 - 1 1/2" Finishing Nails** per piece. Position and attach Side Front Corner Trim (2 1/2" wide) using **8 - 1 1/2" Finishing Nails**, aligning at bottom with wide trim.



**E11.** To completely trim out rear corners, locate **High Side Corner Trims** (1/2" x 2 1/2" x 88 3/4") and **High Corner Trims** (1/2" x 5 1/2" x 88 3/4"). Align and attach as per **Step E10**.



**E12.** Attach **High Middle Trim** (1/2" x 2 1/2" x 88 3/4") where wall panels come together at rear seam. Attach with **8 - 1 1/2" Finishing Nails** aligning tight underneath soffit and center on seam.

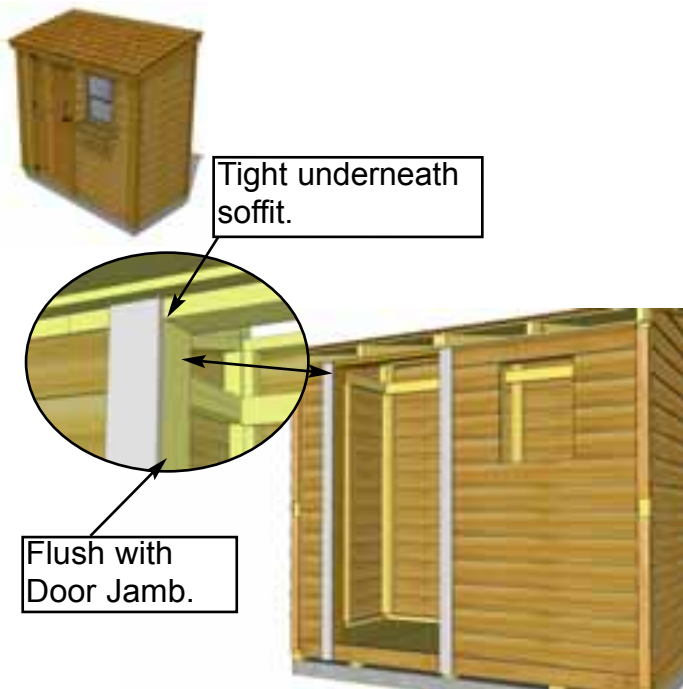

**E13.** Locate SS Vertical Door Trim (2 - 1/2" x 3 1/2" x 79"). Position Door Trim flush with outside of narrow wall stud. Trim should be aligned tight underneath Soffit. Attach with 8 - 1 1/2" finishing nails.



**E13.** Locate GS Vertical Door Trim (2 - 1/2" x 3 1/2" x 77 1/2"). Position so top of Door Trim is flush with bottom of Door Header and edge of Door Trim is flush with inner face of Door Jamb. Attach with 8 - 1 1/2" Finishing Nails.



**E14.** Position and attach Narrow Wall Trim (1/2" x 2 1/2" x 7 3/4") between corner and door trim underneath soffit. Attach with 2 - 1 1/2" finishing nails. Attach SS Horizontal Door Trim (1/2" x 1 1/4" x 32") between door trims, underneath soffit and against door header. User 4 - 1 1/2" finishing nails.



**E14.** Locate GS Horizontal Door Trim (1 - 1/2" x 2 1/2" x 46 3/4"). Position piece as shown and attach with 4 - 1 1/2" Finishing Nails.



**E15.** To trim out window wall, locate **Window Wall Trim** (1 1/2" x 1 1/2" x 45 1/4"). Position at top of window wall up against roof soffit. Attach with 4- 1 1/2" finishing nails.

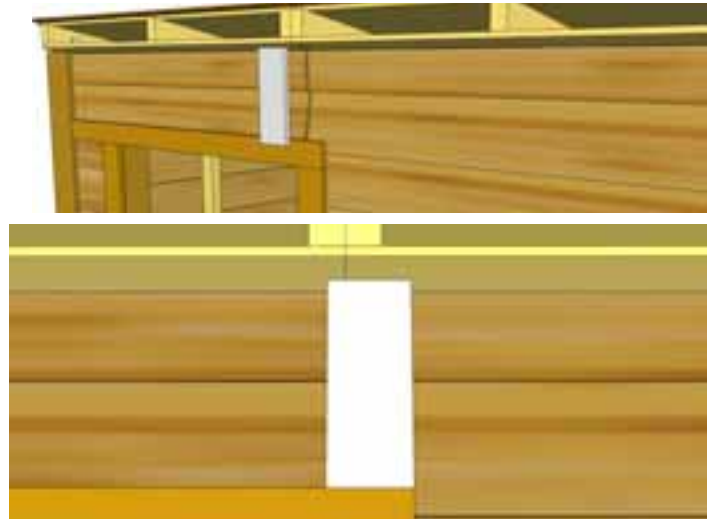

**E15.** Locate **GS Font Middle Trim** (1 - 1/2" x 3 1/2" x 8 3/4"). Position tight against Horizontal Door Trim and in line with Vertical Door Trim. Attach with 2 - 1 1/2" Finishing Nails.

**Important - Drill Pilot Holes to prevent splitting.**

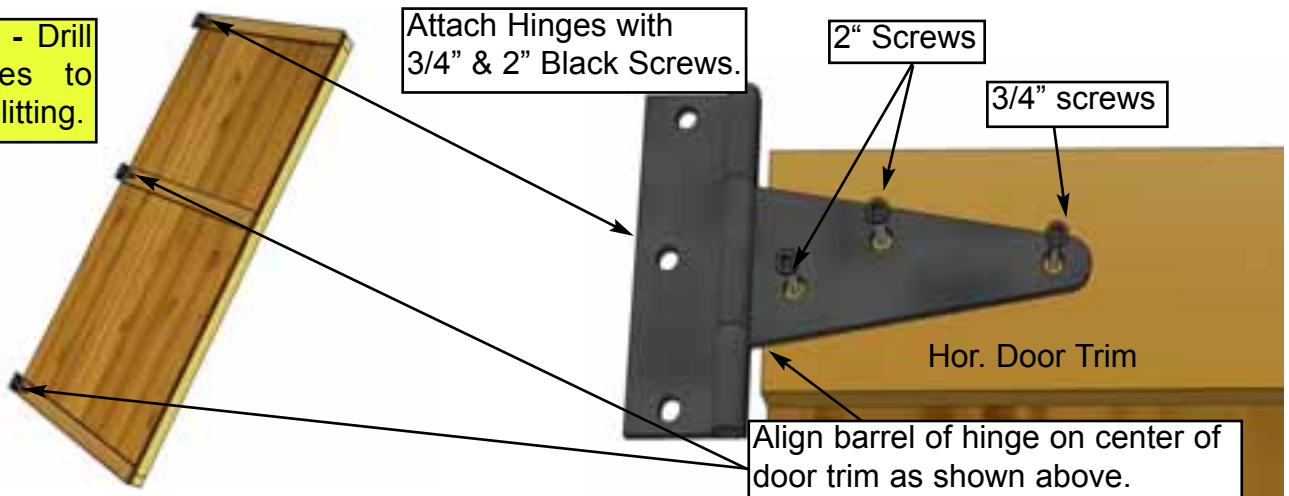

**E16.** Attach Door Hinges to **Solid Door**. Position Hinges equally on door trim as shown above and attach with **Black 3/4"** and **2" Screws**.



**Hint:** Use Shim Shingle or extra piece of siding to help space Door at top and bottom.



**E17.** With Hinges attached, position door in opening. You will need some assistance to hold door in place.

**Important - Drill Pilot holes to prevent splitting.**

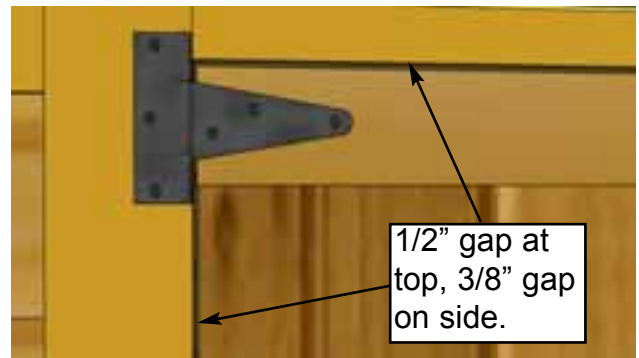
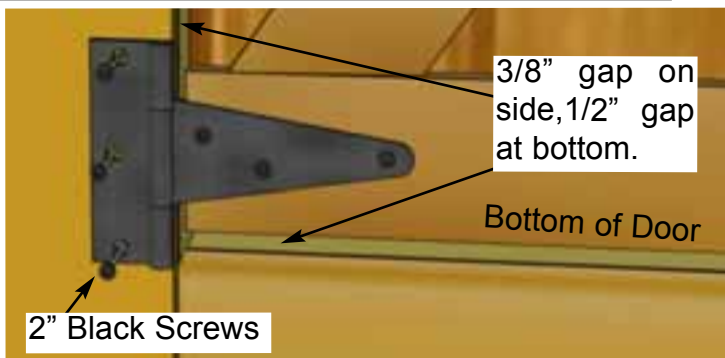

**E18.** Once door is align in opening, position so there is a 1/2" gap on bottom, and approximately 3/8" on the side. Use a spare piece of siding or shingle to shim door in place at the bottom. Using **2" Black Screws**, secure bottom hinge to Door Trim. **Hint:** Do not attach all the 2" screws until the door is positioned correctly. You can use a Screw Driver to tighten screws completely so you don't over tighten.

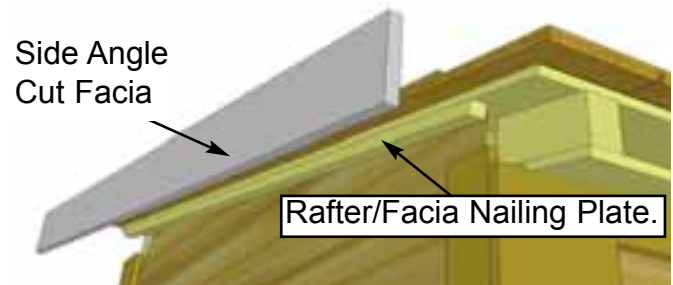
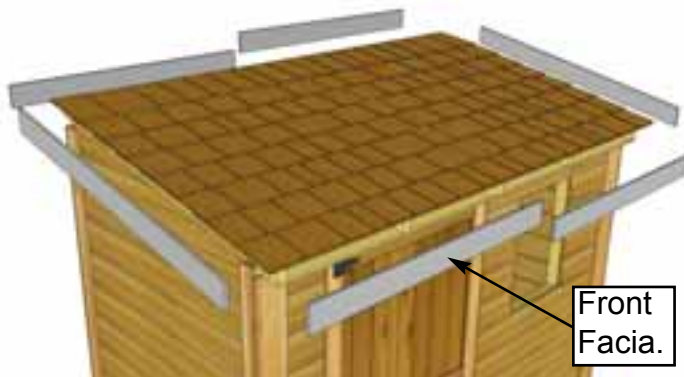

**E19.** Locate and identify all Facia pieces: **Front & Rear Facia (4)** (1/2" x 4" x 50 1/2"). **Side Angle Cut Facia (2)** (1/2" x 4" x 54 1/8"). In front corner, align side and front Facia together. Front facia will cap side facia.

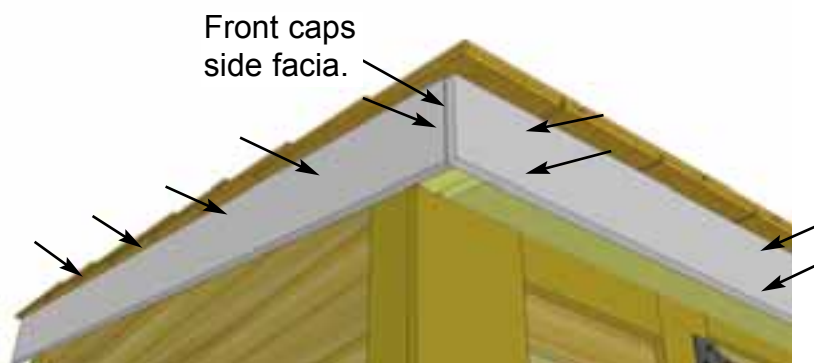

**E20.** Do a dry run first before securing. Position Front Facia up underneath roof panel and against rafter ends. Have your helper hold in position. Place angle cut Side Facia underneath roof panel against Rafter/Facia Nailing Strip. Align so Front Facia caps Side Facia and then attach the front with **6 - 1 1/2" Finishing Nails**. Attach side with **5 - 1 1/2" Finishing Nails** securing them into the nailing plate (closer to the top of the side facia board). Attach next piece of Front Facia. **Note:** With Front Facia correctly aligned at corners, a small gap may occur at center seam. This will be covered by Facia Detail Plate in **Step E22**.

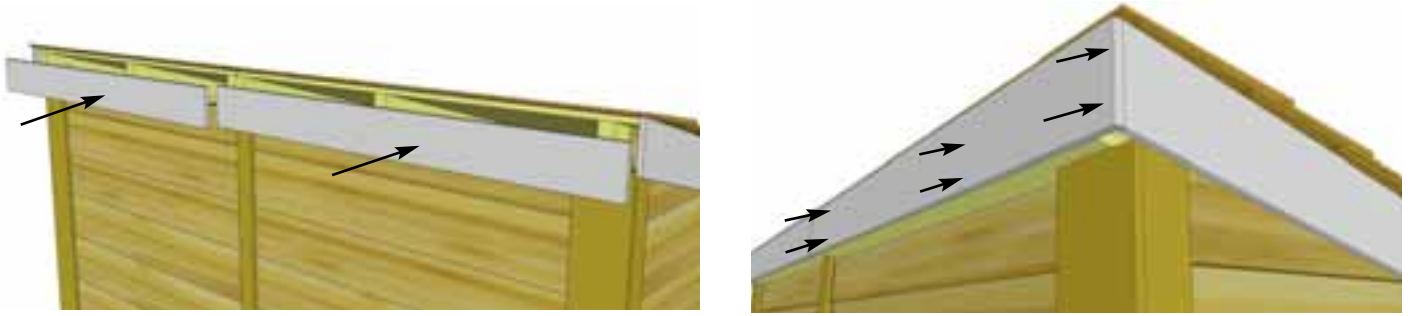

**E21.** Place and align rear and side fascia for best possible fit with rear capping side fascia. Attach fascia to rafter ends with **6 - 1 1/2" Finishing Nails** per piece. Complete both rear fascia pieces.

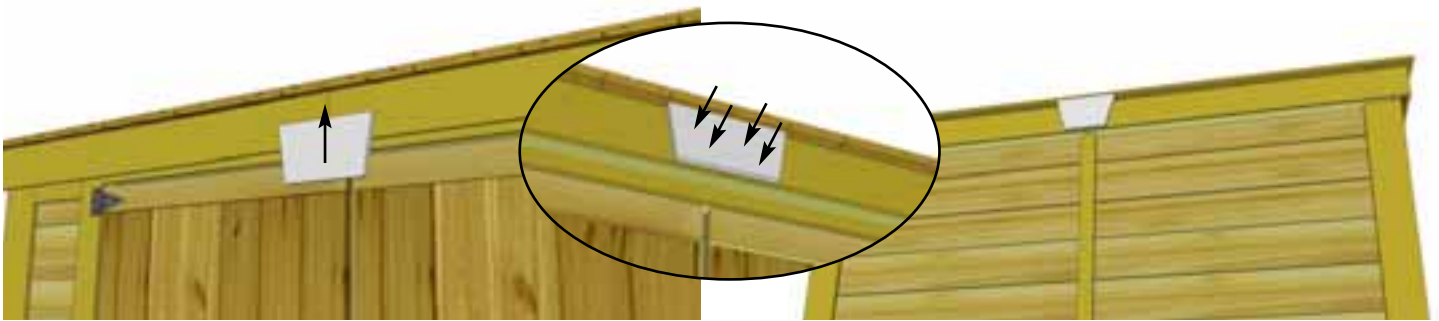

**E22.** Attach **Facia / Detail Plates** to cover seams where Front and Rear Facia pieces come together. Secure with **4 - 1 1/2" Finishing Nails** per piece.

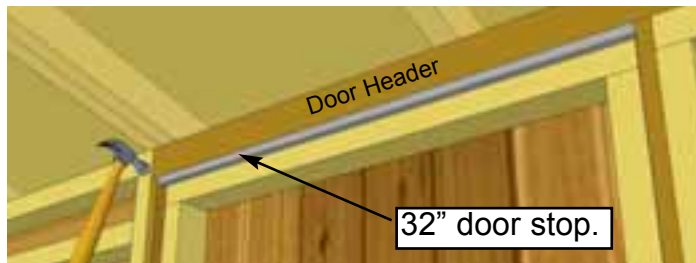

**E23.** Attach **Upper Interior Door Stop** (1/2" x 1/2" x 32") positioning trim against door jamb and underneath door header flush to edges on inside as shown above. Attach with **4 - 1 1/2" Finishing Nails**.

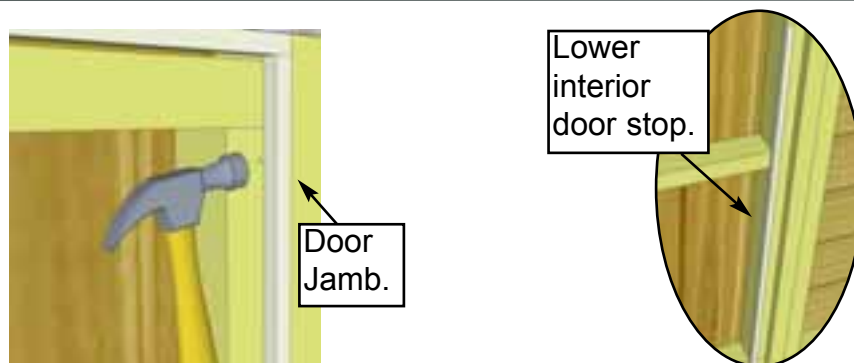

**E24.** Attach upper and lower **Vertical Interior Door Stops** as per **Step E23**. Position against door jamb and underneath upper door trim. Attach with **4 - 1 1/2" Finishing Nails** per piece. Complete both sides.

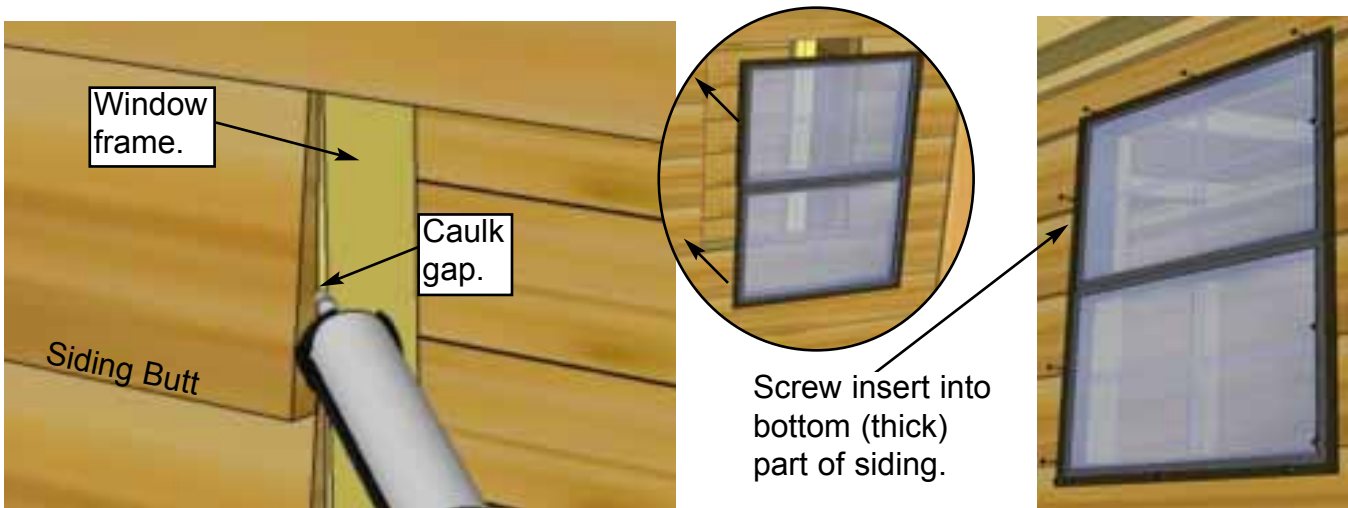

**E25.** To reduce possible water from penetrating into the window cavity, caulk gap on both sides of window opening prior to installing **Window Insert**. Position insert in cavity and screw with **6 - 8 1 1/4" Screws**. On sides, make sure to screw insert into the thick butt of the siding only.

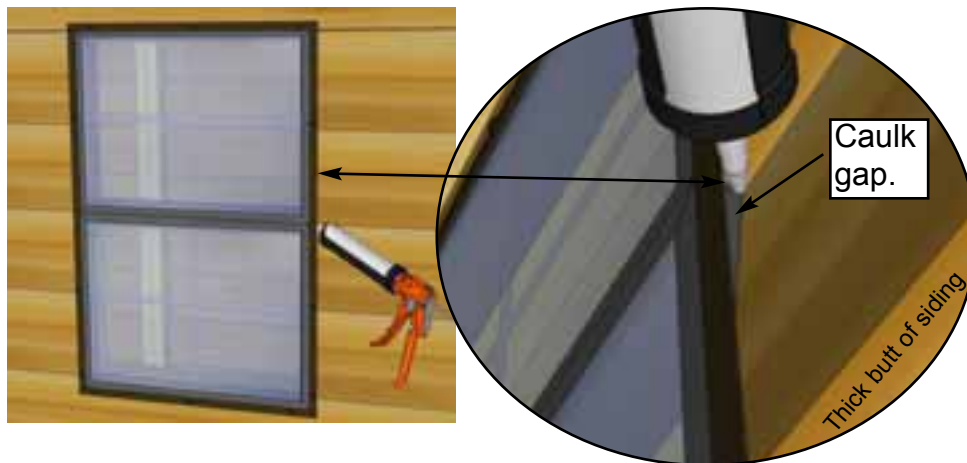

**E26.** Once Insert is attached, caulk the "triangular gap" between the Insert's outside flange and the siding. Also put a bead of caulking horizontally at top of window where the flange and siding meet. This additional caulking will also reduce the chances of moisture entering into your shed.

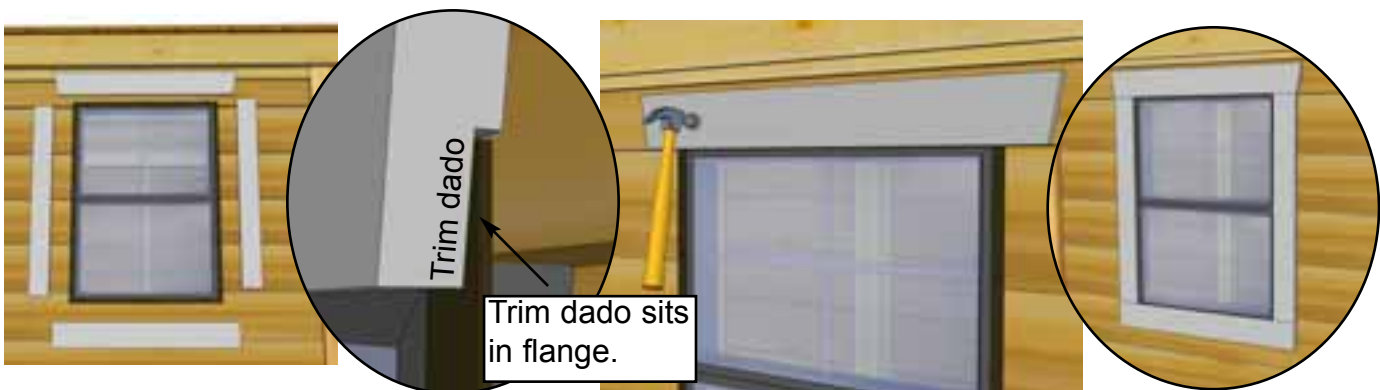

**E27.** Position **Window Trim** around window doing a dry run first and attach with **4 - 1 1/2" Finishing Nails** per piece. Trim Sizes = 1 x 24 1/16" = top (angle cut on ends) / 3 x 23" = Sides & Bottom. Window trim has a small dado on reverse face. Outside flange of window will roughly sit in the dado to give a better fit.



**E28.** Attach **Door Handle**. Handle should be positioned with larger flange to top. Mount with 4 - 3/4" Black Headed Screws.

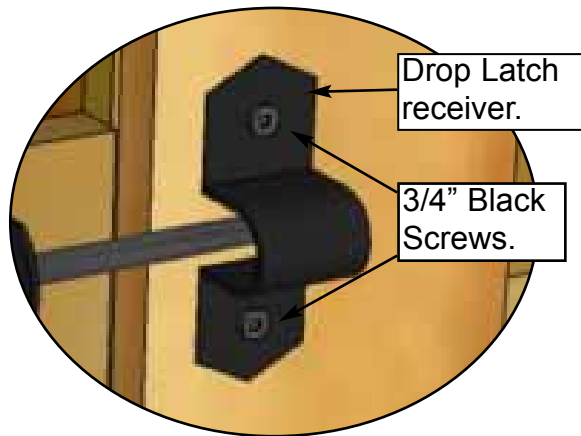

**E29.** Attach Black Drop Latch as illustrated above with 6 - 3/4" Black Screws. Note how Drop Latch receiver is positioned higher than male. Do a dry run first to position Drop Latch correctly. **Important** - Drill pilot holes with 1/8" drill bit prior to securing with screws to prevent wood splitting. Drill shallow pilot hole only since the screw is only 3/4" long.



**E30.** Assemble Flower Box with Assembly Instructions included with this Manual on Page 53. Center completed flower box below bottom of window trim and secure with 2 - 2 1/2" Screws. Screw from inside of box into the center wall stud. Attach second screw 2" below first screw.

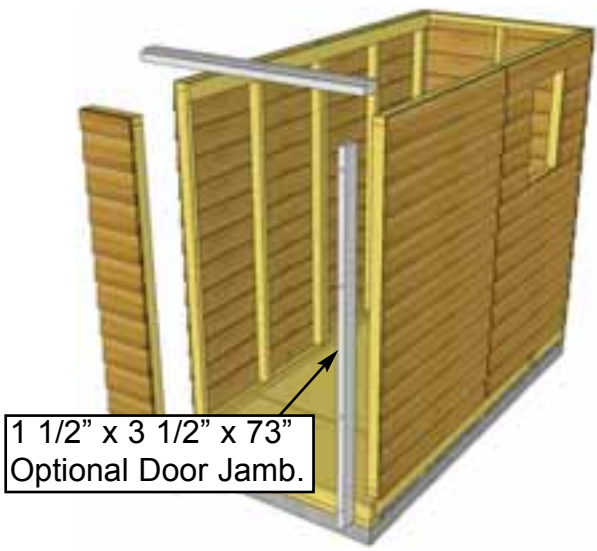

1 1/2" x 3 1/2" x 73"  
Optional Door Jamb.

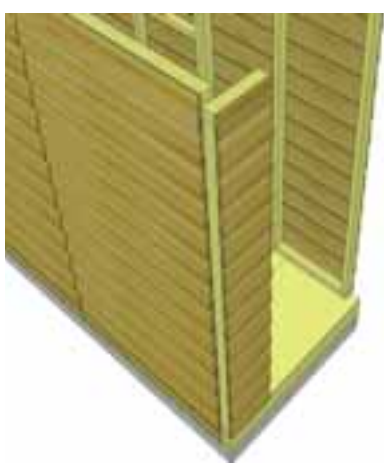
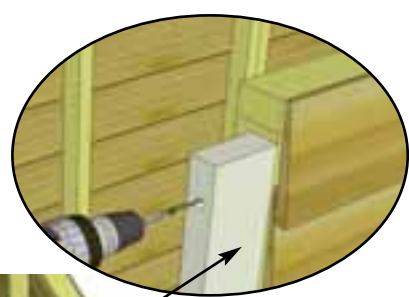

1. Install Narrow Wall as per Step B9.

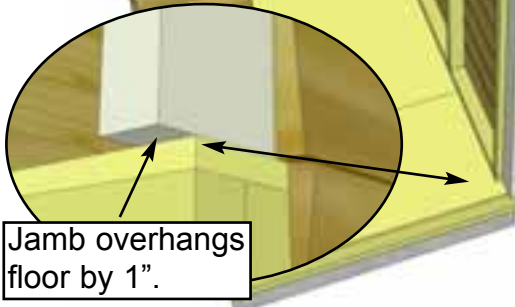

Jamb overhangs floor by 1".

2. Position Optional Door Jamb as shown to the right and attach using 4 - 4" Screws in the pre-drilled holes. Line up Jamb with outside of Side Wall Framing. Use Door Header (45 1/2" long) to align Jamb. Jamb will overhang floor at bottom.

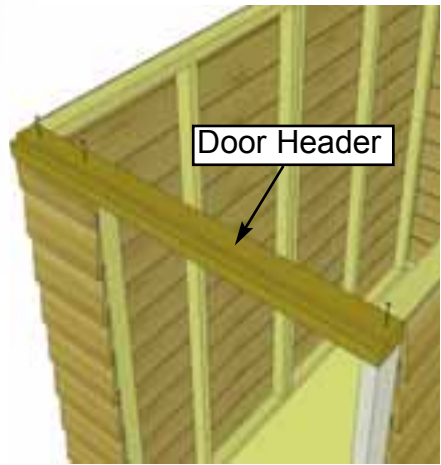

Door Header

3. Attach Door Header as per Step B13.

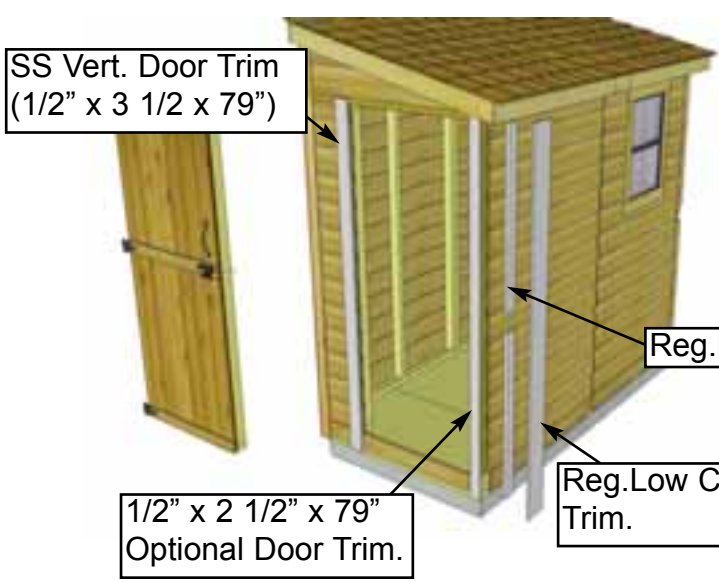

SS Vert. Door Trim (1/2" x 3 1/2" x 79")

1/2" x 2 1/2" x 79"  
Optional Door Trim.

Reg. Filler Trim.

Reg. Low Corner Trim.

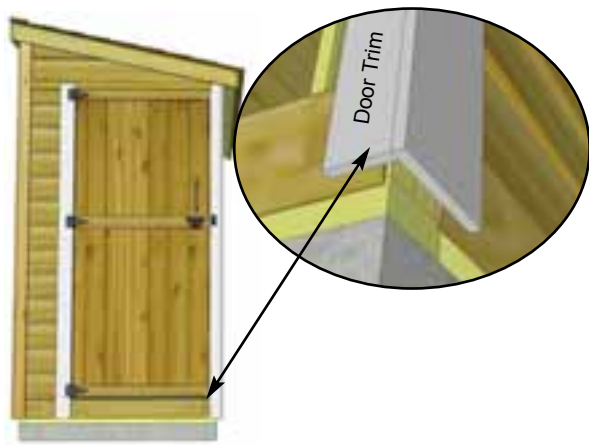

Door Trim

4. Install SS Vertical Door Trim and Hang Door as per Step E13 and Step E17. Attach optional trim as shown. Trim corner as per regular steps.

# Outdoor Living Today Flower Box Assembly Instructions

Exploded View

## Parts Lists:

<b>A - Base, Rear &amp; Front Box Frames (3pcs)</b>	$3/4" \times 5 1/2" \times 23"$
<b>B - End Cap Frames (2pcs)</b>	$3/4" \times 5 1/2" \times 7" / 8"$
<b>C - Front Trim (1 pc)</b>	$3/4" \times 1 1/2" \times 26"$
<b>D - Side Trims (2 pc)</b>	$3/4" \times 1 1/2" \times 8 3/4"$
<b>E - Brackets (2 pc)</b>	$1 1/2" \times 5 1/2" \times 5 1/2"$
<b>F - 1 1/4" Screws</b>	
<b>G - 1 1/4" Nails</b>	

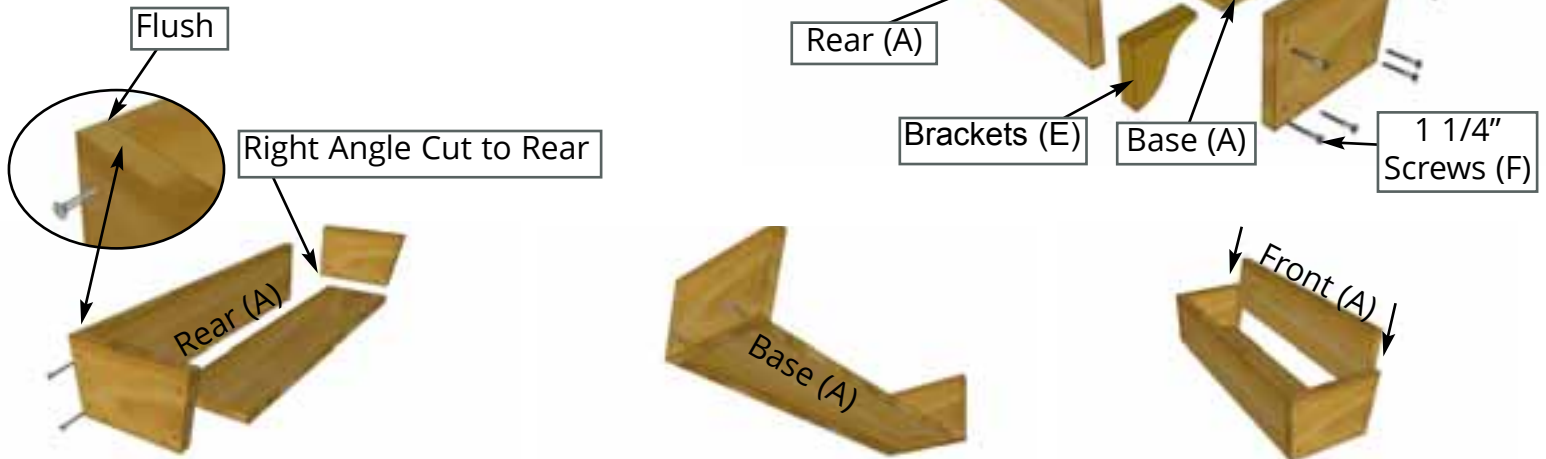

**1.** On a table position Rear Box and End Cap Frames together so flush at top. Fasten together with 2 - 1 1/4" screws. Place Base Frame tight against Rear and End Cap and flush at bottom. Secure with 2 - 1 1/4"

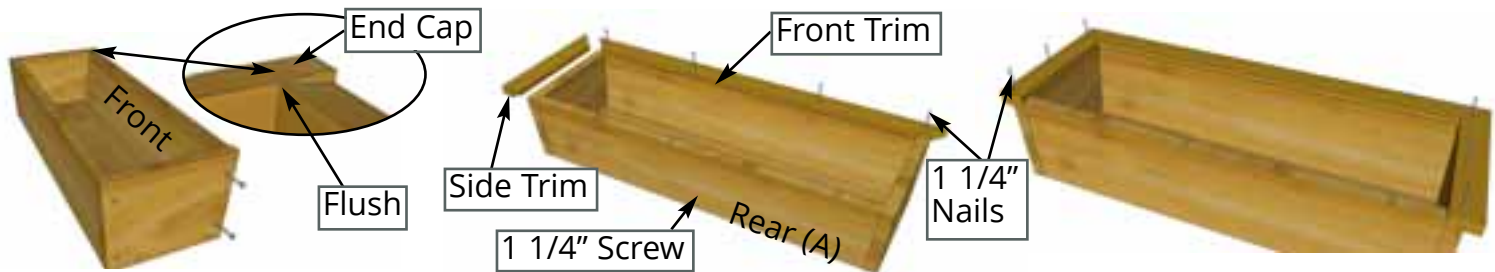

**2.** Position Front Frame Piece flush with End Cap. Attach both ends with 2 - 1 1/4" screws. Pilot hole Rear Box Frame near bottom center and secure to Base edge with 1 - 1 1/4" screw. Evenly position Front Trim (mitre cut on end and dado cut on inside bottom) tight against front frame and nail down with 4 - 1 1/4"

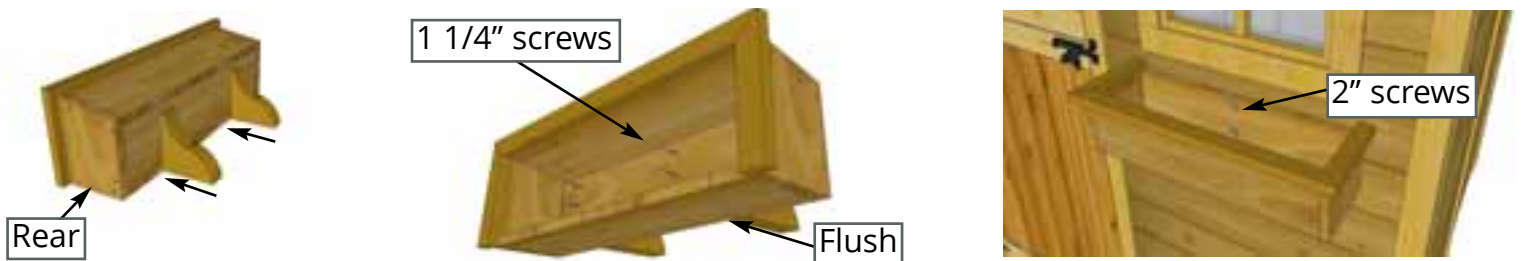

**3.** On a flat surface, flip Flower Box on it's rear face. Evenly space Brackets and secure through Base Frame and into the Brackets with 2 - 1 1/4" screws per Bracket. Position completed Flower Box beneath window trim



# Outdoor Living Today



Congratulations on assembling your 8x4 SpaceSaver / Gardensaver!

Note: Our Sheds are shipped as an unfinished product. If exposed to the elements, the lumber will weather to a silvery-gray color. If you prefer to keep the lumber looking closer to the original color, we suggest that you treat the wood with a good oil base wood stain. You may also wish to paint your new shed rather than stain it. In both cases we recommend that you consult with a paint and stain dealer in your area for their recommendations.



We hope your experience constructing our **8x4 SpaceSaver** has been both positive and rewarding. We value your feedback and would like to hear back from you on how well we are doing in the following areas:

- 1. Customer Service**
- 2. On Time Shipping**
- 3. Motor Freight Delivery**
- 4. Quality of Materials**
- 5. Assembly Manual**
- 6. Overall Satisfaction**



The materials contained in this Assembly Manual may be downloaded or copied provided that ALL copies retain the copyright and any other proprietary notices contained on the materials. No material may be modified, edited or taken out of context such that its use creates a false or misleading statement or impression as to the positions, statements or actions.

Please call, write or email us at:

Canadian Address  
9393 287th Street  
Maple Ridge, British Columbia  
Canada V2W 1L1

United States Address  
P.O. Box 96  
Sumas, Washington  
USA 98295

Toll Line: 1.888.658.1658

| Fax: 1.604.462.5333

| [sales@outdoorlivingtoday.com](mailto:sales@outdoorlivingtoday.com)