

Owner Manual

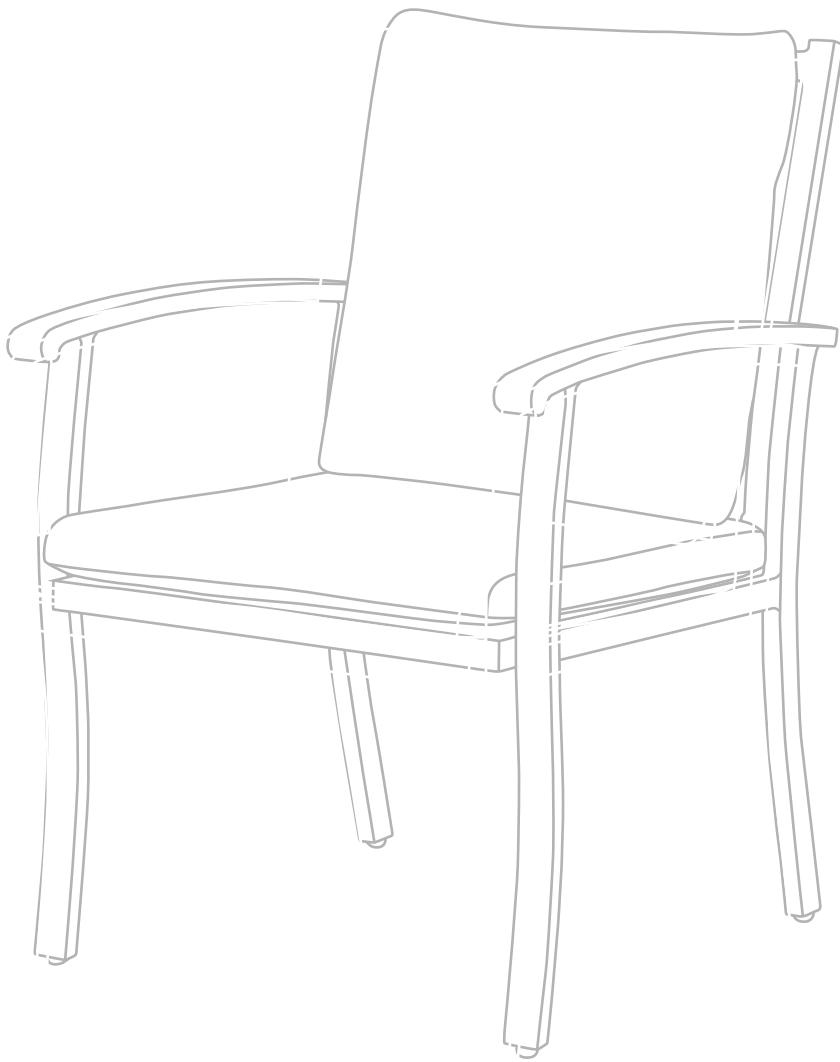

SAFETY PRECAUTIONS

WARNING



Please read and understand this entire manual before attempting to assemble or install the product.



Some parts may have sharp edges. Please wear protective gloves when assemble or install the product.



Assemble the item on a soft, non-abrasive surface to avoid damage, such as carpeting.



Keep all the children and pets away from assembly area. Children and pets should be supervised when they are in the area of the dining set construction.



The item is heavy. Please handle it carefully. Two or more people are required for assembly.

CAUTION

- ★ Chair is used for sitting only. Do not stand on it or use any part of this item as a step ladder.
 - ★ Recommended maximum sitting weight for the chair set is 250lbs /113 kgs.
 - ★ Please do not exceed the weight limitations of this item.
 - ★ Firmly secure all bolts, screws and knobs before use. Reconfirm that all bolts, screws, and knobs are secure every 90 days.
 - ★ Do not use or store this item in the proximity of open flame or flammable/combustible chemicals.
 - ★ If any parts are missing, broken, damaged, or worn, stop using this product until repairs are made and/or factory replacement parts are installed.
-

ATTENTION

- ★ Check every part with the part list before assembly. If any part is missing or damaged, do not attempt to assemble the product and contact us immediately.
 - ★ We care about every customer's experience. Please feel free to contact us if you have any advice. We will offer you efficient solutions ASAP.
 - ★ We recommend you to use waterproof furniture cover for the entire patio dining set when out of use to keep them longer performance.
 - ★ You could adjust the foot leveler to keep table or chair in balance.
-

WARRANTY COVERAGE REQUIREMENTS

- ★ Pictures of the damaged parts. The order number of your product.
 - ★ Please gather all of this information BEFORE you contact us.
 - ★ Do not use this item in a way inconsistent with the manufacturer's instructions as this could void the product warranty.
-

ACCESSORIES DISPLAY

Back

A

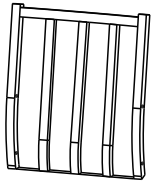

1 PC

Seat

B

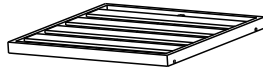

1 PC

Armrest (Left)

C

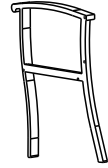

1 PC

Armrest (Right)

D



1 PC

Wrench

E



1 PC

M6X28MM

F



4 PCS

M6X45MM

G



4 PCS

Steel Washer

H



8 PCS

NOTICE:

This is an illustration of the parts of a chair.

PRODUCT ASSEMBLY

STEP 1

x2



F : 2 PCS

x2



H : 2 PCS

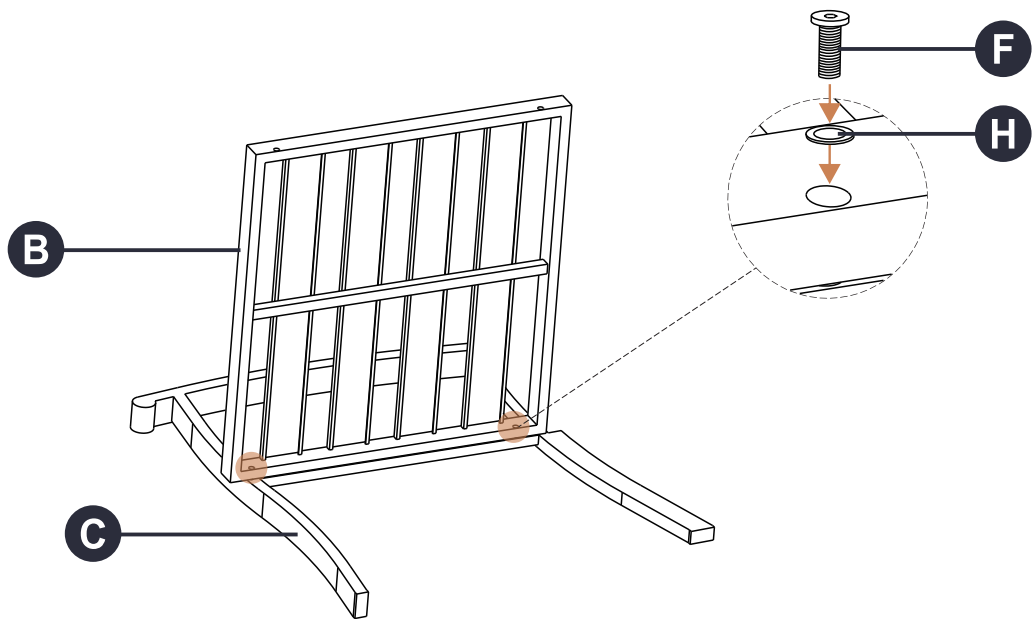

NOTICE:

Please assemble the item on a soft, non-abrasive surface such as carpeting to avoid damage.

STEP 2

x2



G : 2 PCS

x2



H : 2 PCS

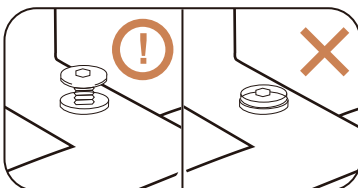
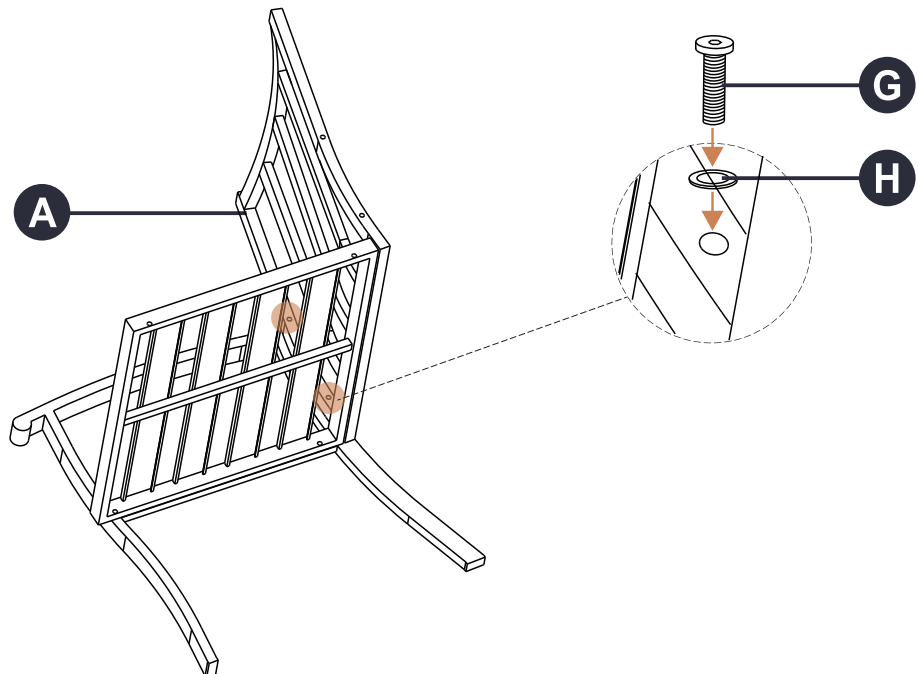

In order to increase efficiency, it is recommended to simply fix all accessories with screws and then tighten the screws altogether.

PRODUCT ASSEMBLY

STEP 3

x2



F : 2 PCS

x2



G : 2 PCS

x4



H : 4 PCS

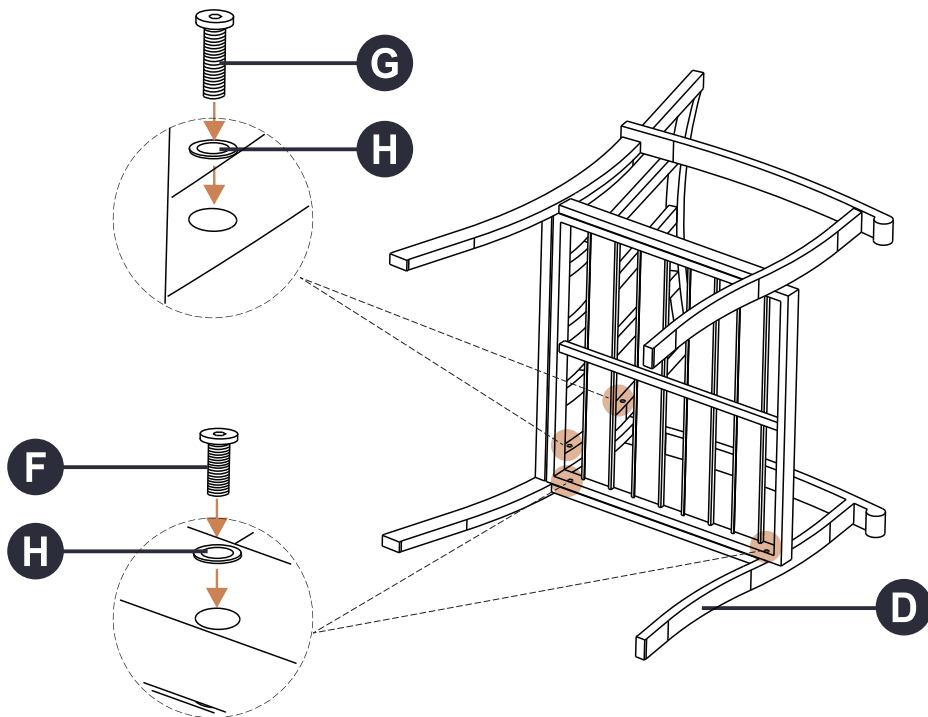

Complete

