

*** Thank you for purchasing this quality product. Be sure to check all packing materials carefully for small parts which may have come loose inside the carton during shipment. Identify and count all parts and compare with parts list below.

*** Assemble product on a flat, soft surface such as a carpet or cloth to prevent scratching the finish. Read all instruction and study the drawings carefully before starting the assembly process.

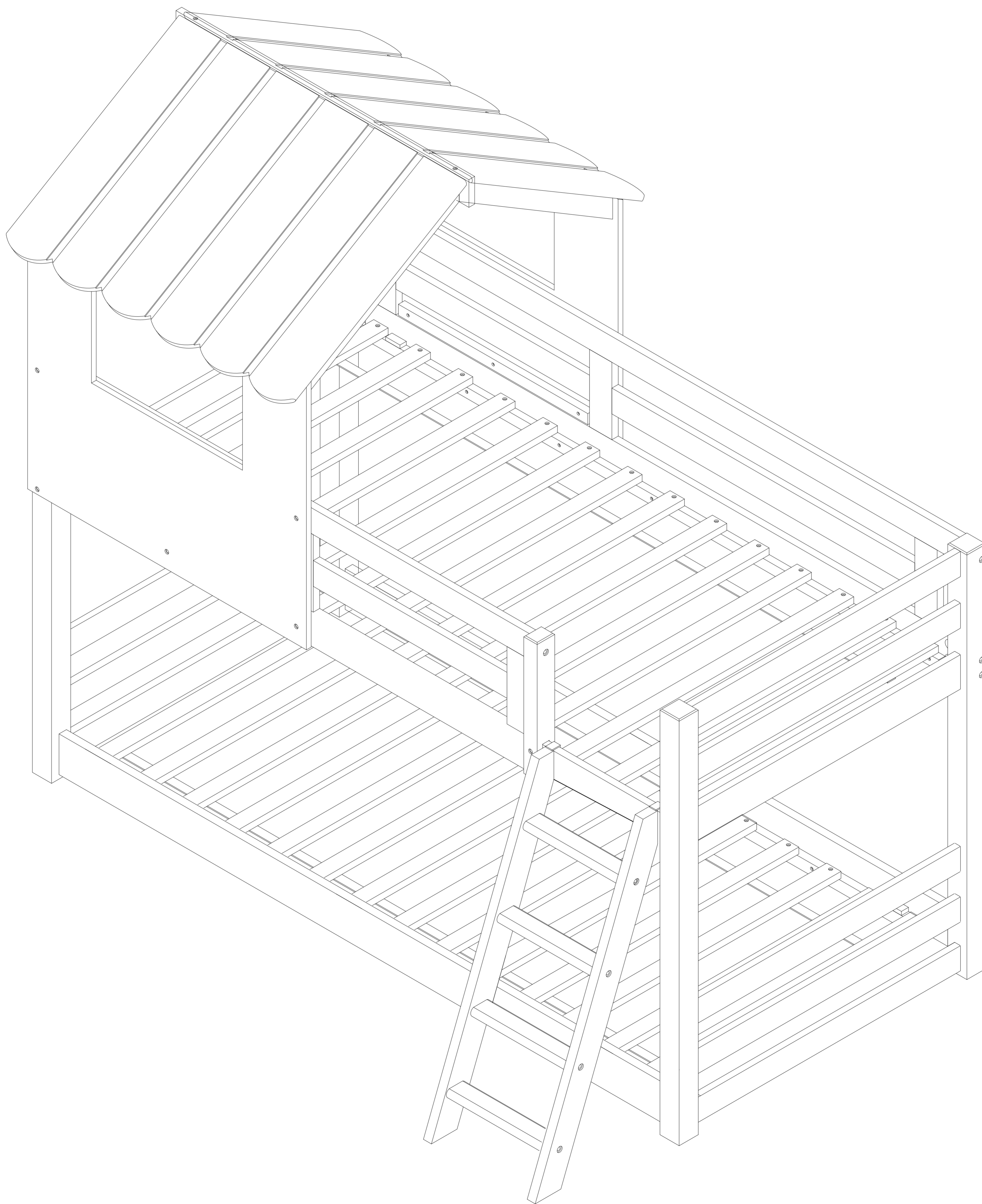



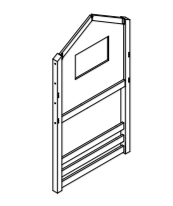
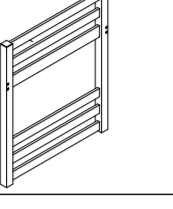
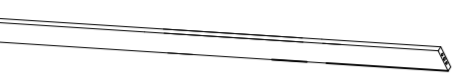
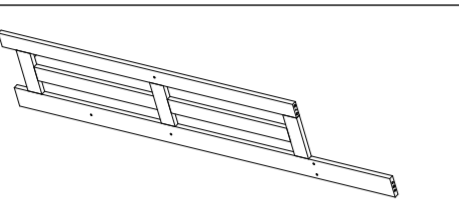
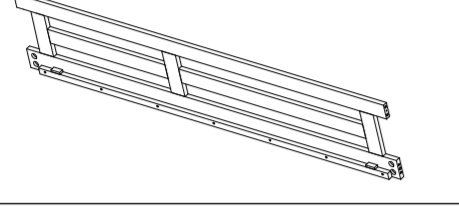
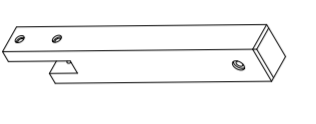
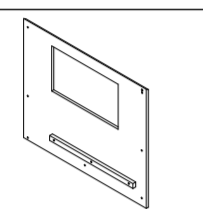
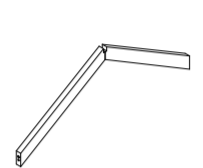
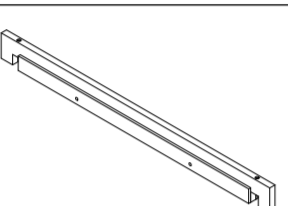
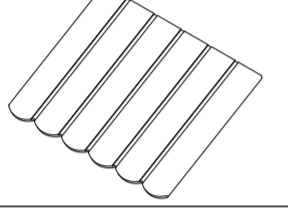
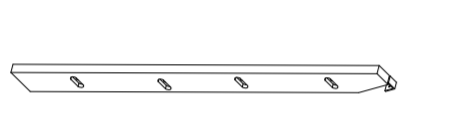
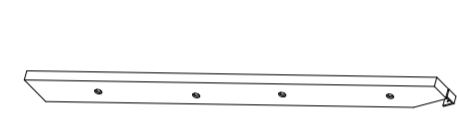
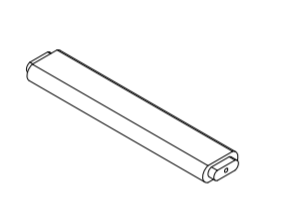
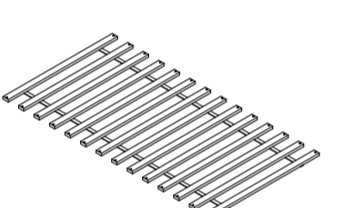

IMPORTANT: Do not tighten bolts completely until all bolts are completely lined up and inserted into holes

PARTS LIST

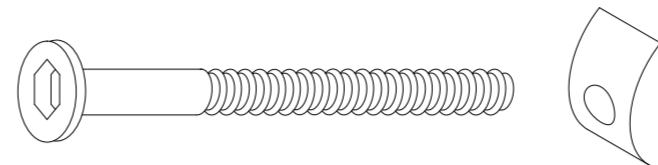
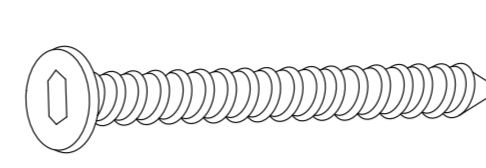
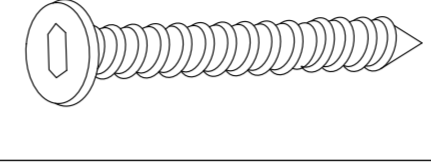
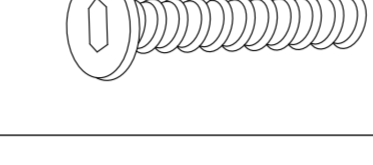
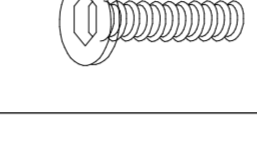
NO.	DIAGRAM	PART NAME	Q'Ty
1		Headboard (Left)	1 pc
2		Headboard (Right)	1 pc
3		Bottom Rail	2 pcs
4		Upper Front Rail	1 pc
5		Upper Back Rail	1 pc
6		Guardrail Support	1 pc
7		Side Panel	2 pcs
8		Rafter	1 pc
9		Ridge board	1 pc
10		Roof Panel	2 pcs
11		Ladder Left	1 pc
12		Ladder Right	1 pcs
13		Ladder Step	4 pcs
14		Completed Twin Slat (14pcs/1set)	2 sets

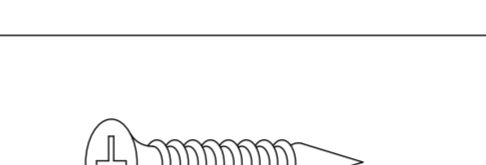
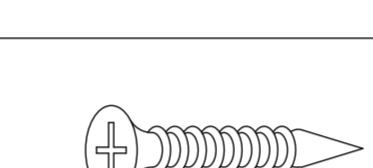
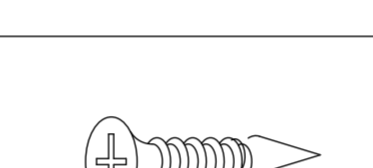
HARDWARE LIST

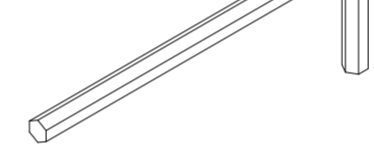
NO.	DIAGRAM	PART NAME	Q'Ty
A		Bolt: 6.3 x 100 (mm) Half Round Nut	16 sets
B		Long Screw 7 x 100 (mm)	3 pcs
C		Long Screw 7 x 80 (mm)	1 pc
D		Short Screw 7 x 50 (mm)	8 pcs
E		Short Bolt 6.3 x 25 (mm)	12 pcs
F		Short Bolt 6.3 x 50 (mm)	2 pcs
G		Short Bolt 6.3 x 45 (mm)	2 sets
H		Wood Dowel 10 x 40 (mm)	16 pcs
I		Screw 4 x 50 (mm)	6 pcs
J		Screw 4 x 30 (mm)	56 pcs
L		Screw 4 x 25 (mm)	4 pcs
M		Screw 4 x 20 (mm)	2 pcs
N		Allen Key (M4)	1 pc

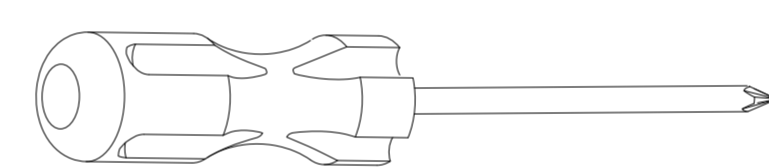

TOOL REQUIRED:



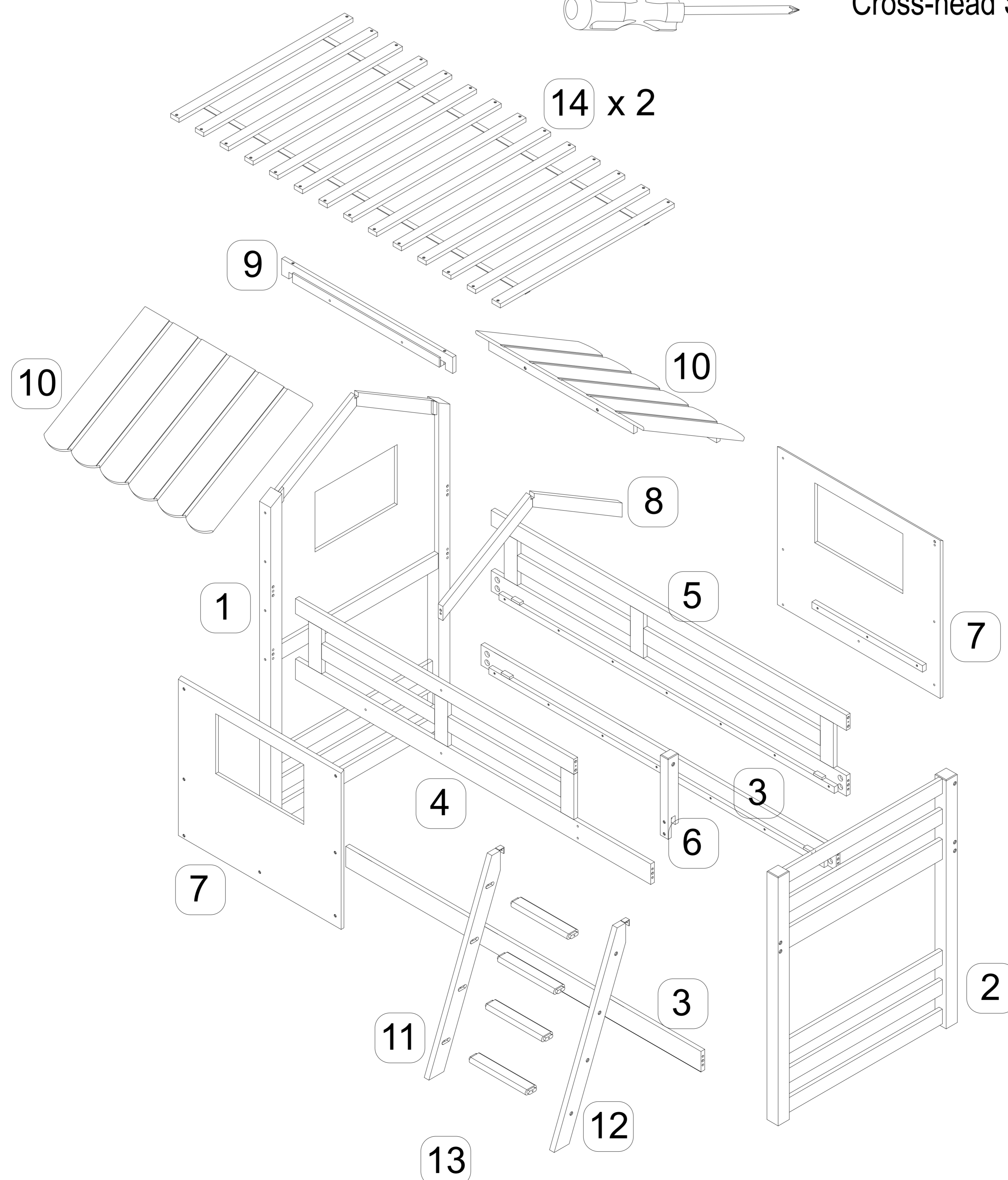



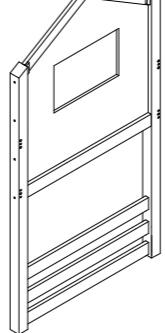
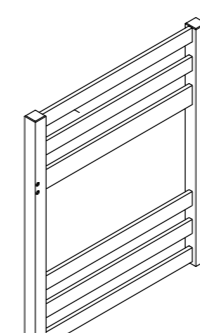
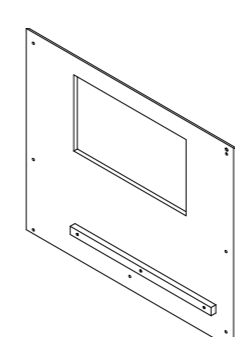
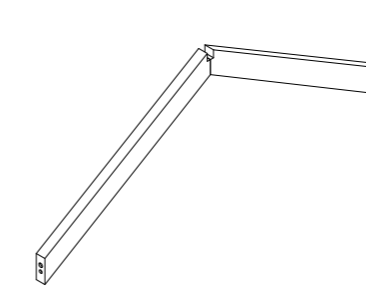
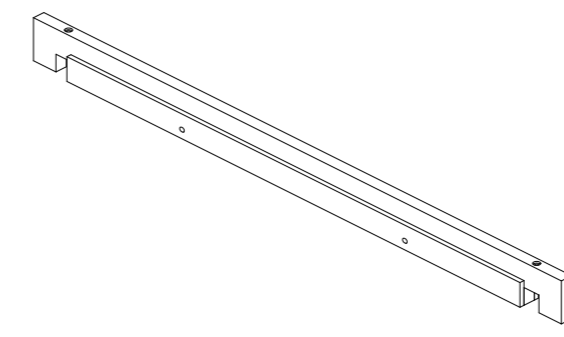
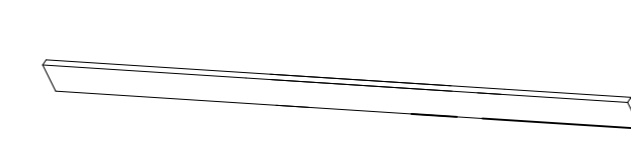
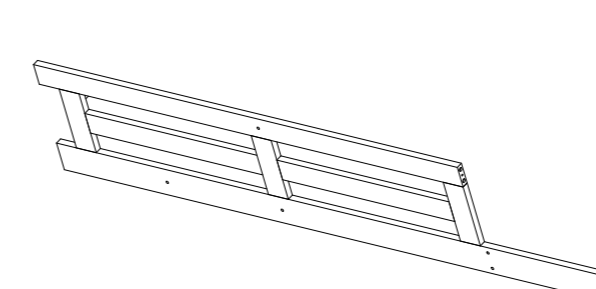
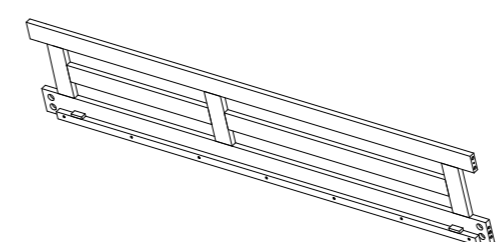

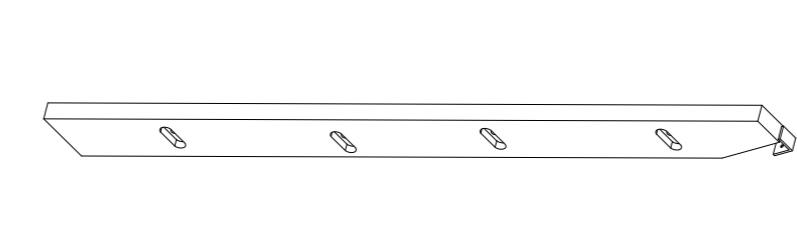
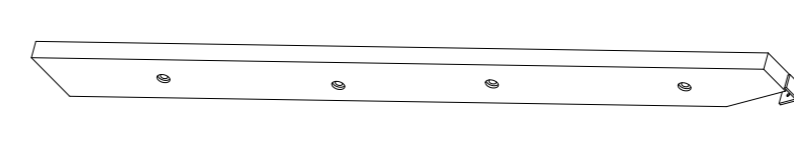
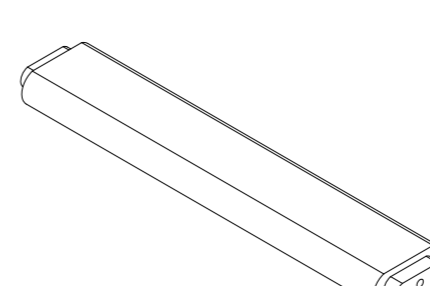
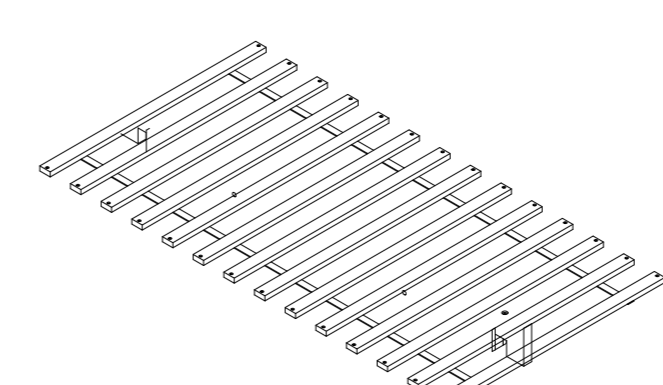
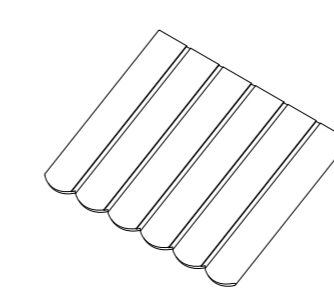
Cross-head Screwdriver (Not provided)

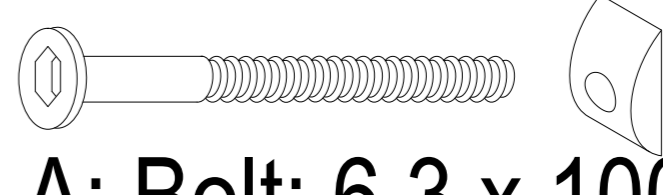
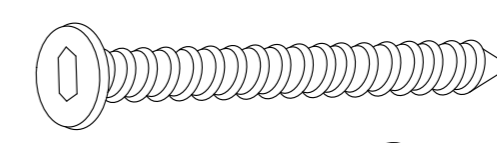
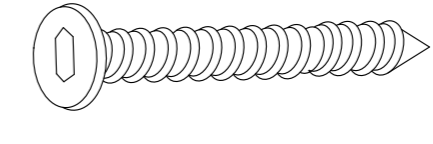
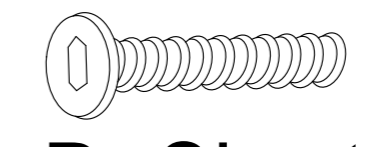

#BD00705 is packed in 3 cases

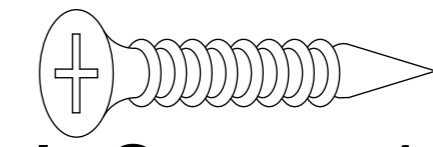
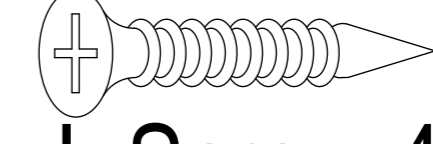
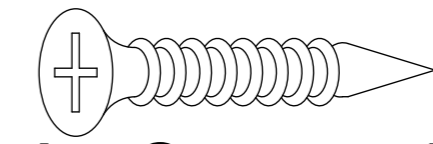
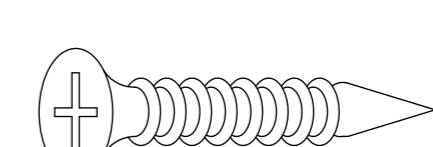
Carton	Disignation	Part	Hardware
Item: #BD00705-1	Headboard(Left) x 1pc	#1	
	Headboard(Right) x 1pc	#2	
	Side Panel x 2pcs	#7	
	Rafter x 1pc	#8	
	Ridge board x 1pc	#9	
Item: #BD00705-2	Bottom Rail x 2pcs	#3	
	Upper Front Rail x 1pc	#4	
	Upper Back Rail x 1pc	#5	
	Guardrail Support x 1pc	#6	
	Ladder Left x 1pc	#11	
	Ladder Right x 1pc	#12	
	Ladder Step x 4pcs	#13	
	Completed Twin Slat (14pcs/1set)x 2sets	#14	
Item: #BD00705-3	Roof Panel x 2pcs	#10	

-  A: Bolt: 6.3 x 100 (mm) x 16sets
Half Round Nut
-  B: Long Screw 7 x 100 (mm) x 3pcs
-  C: Long Screw 7 x 80 (mm) x 1pc
-  D: Short Screw 7 x 50 (mm) x 8pcs
-  E: Short Bolt 6.3 x 25 (mm) x 12pcs
-  F: Short Bolt 6.3 x 50 (mm) x 2pcs
-  G: Short Bolt 6.3 x 45 (mm) x 2pcs
-  H: Wood Dowel 10 x 40 (mm) x 16pcs
-  I: Screw 4 x 50 (mm) x 6pcs
-  J: Screw 4 x 30 (mm) x 56pcs
-  L: Screw 4 x 25 (mm) x 4pcs
-  M: Screw 4 x 20 (mm) x 2pcs
-  N: Allen Key (M4) x 1pc

STEP 1: BOTTOM RAILS ASSEMBLY

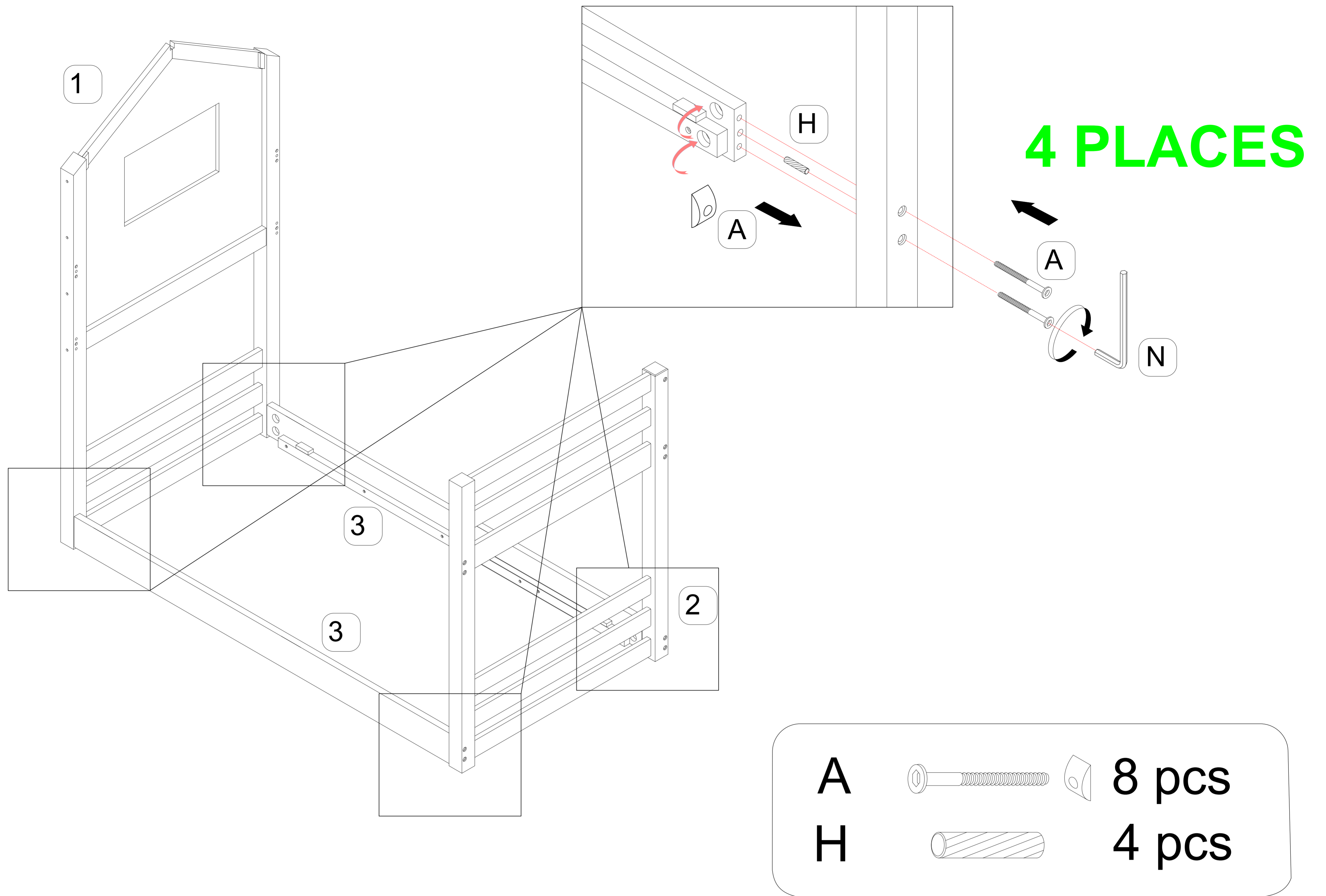

STEP 2: UPPER RAILS ASSEMBLY

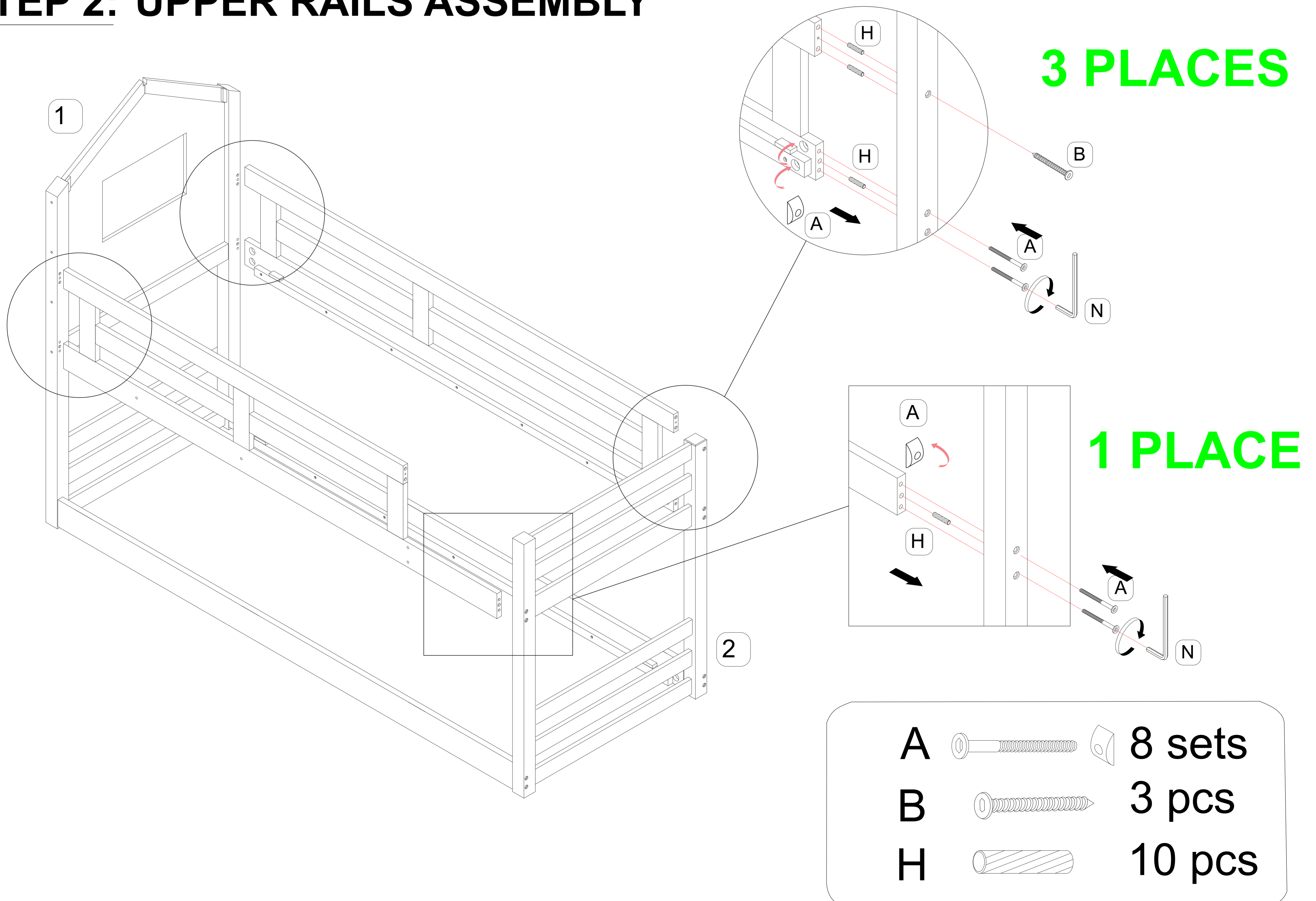

STEP 3: SIDE PANEL ASSEMBLY

E

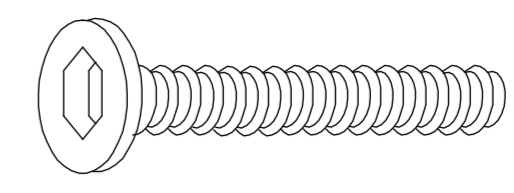

12 pcs

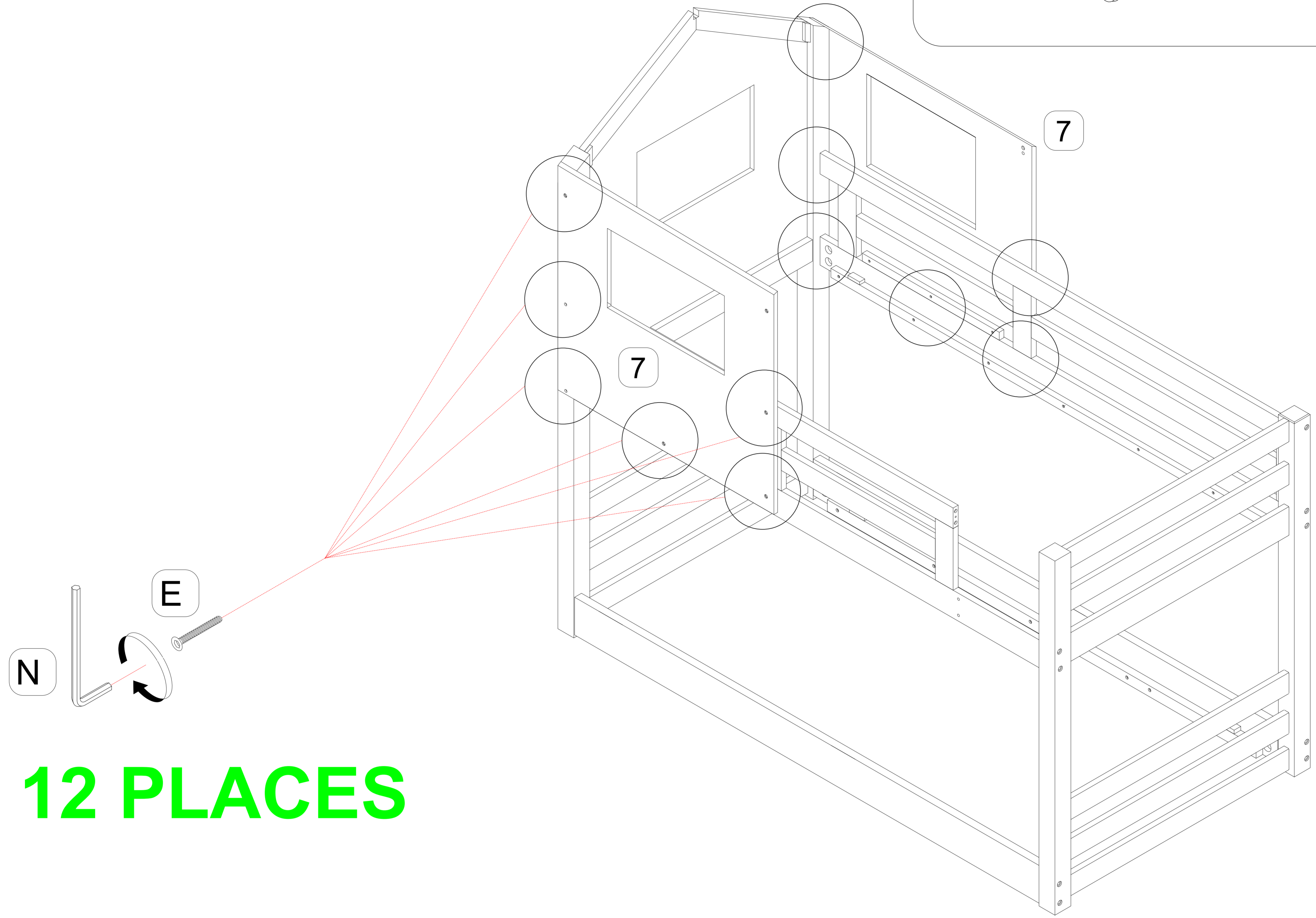

12 PLACES

STEP 4: RIDGE BOARD ASSEMBLY

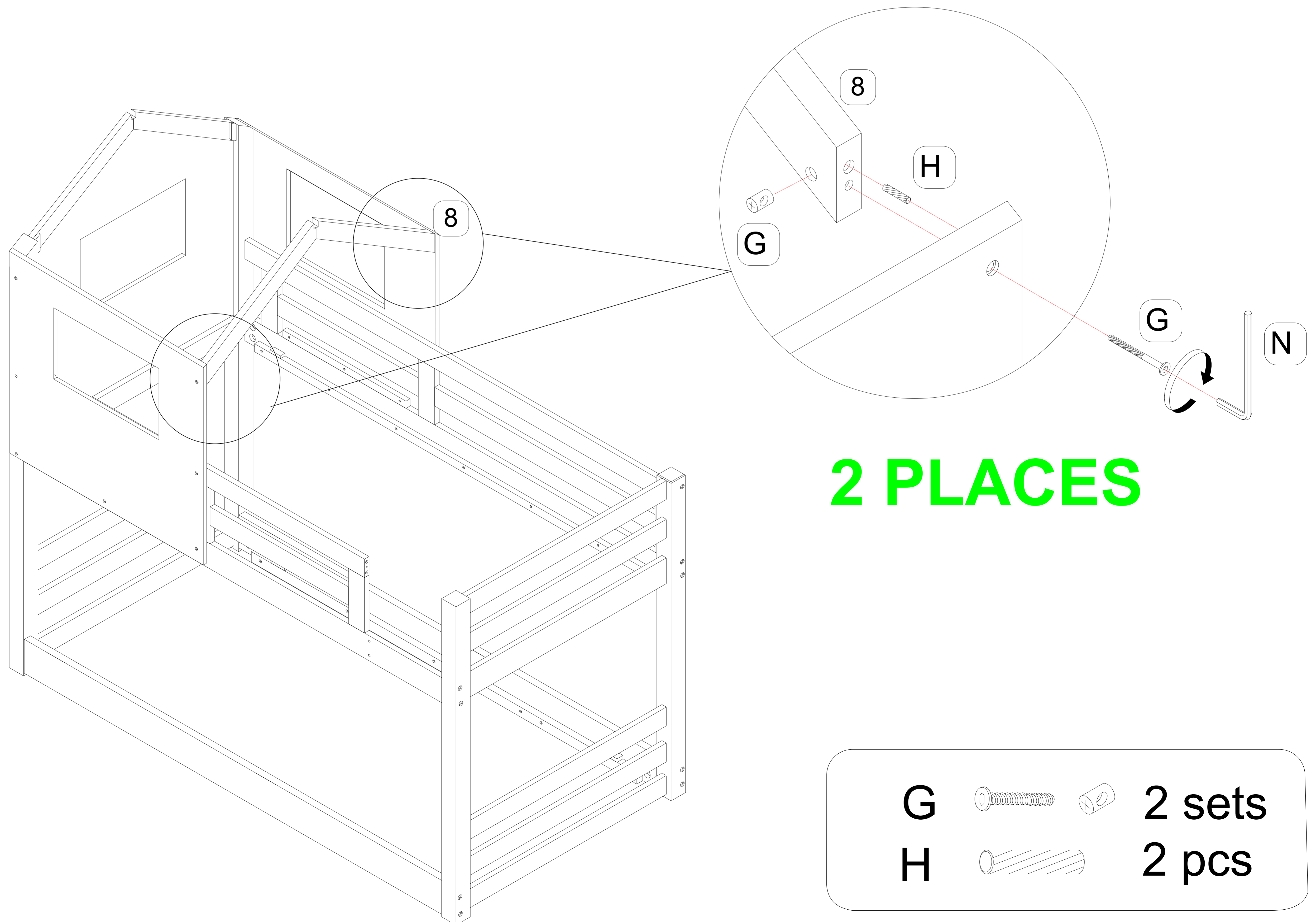

2 PLACES

G

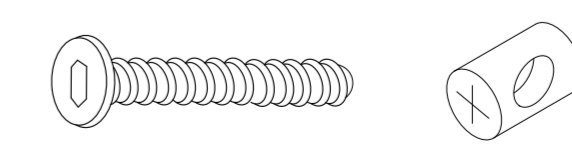

2 sets

H

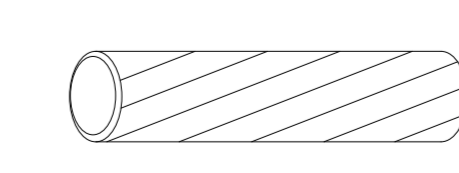

2 pcs

STEP 5: RAFTER ASSEMBLY

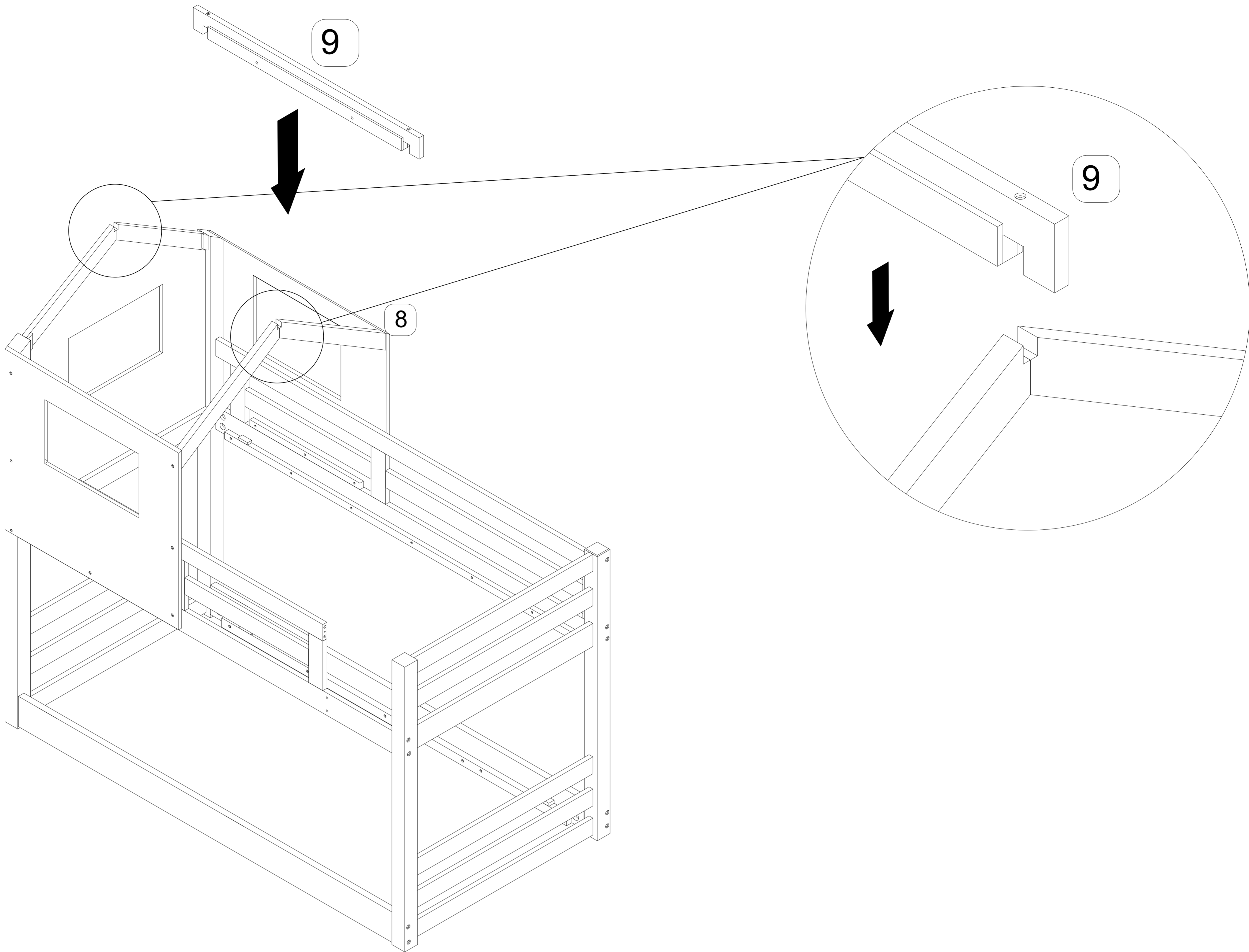

STEP 6: ROOF PANEL ASSEMBLY

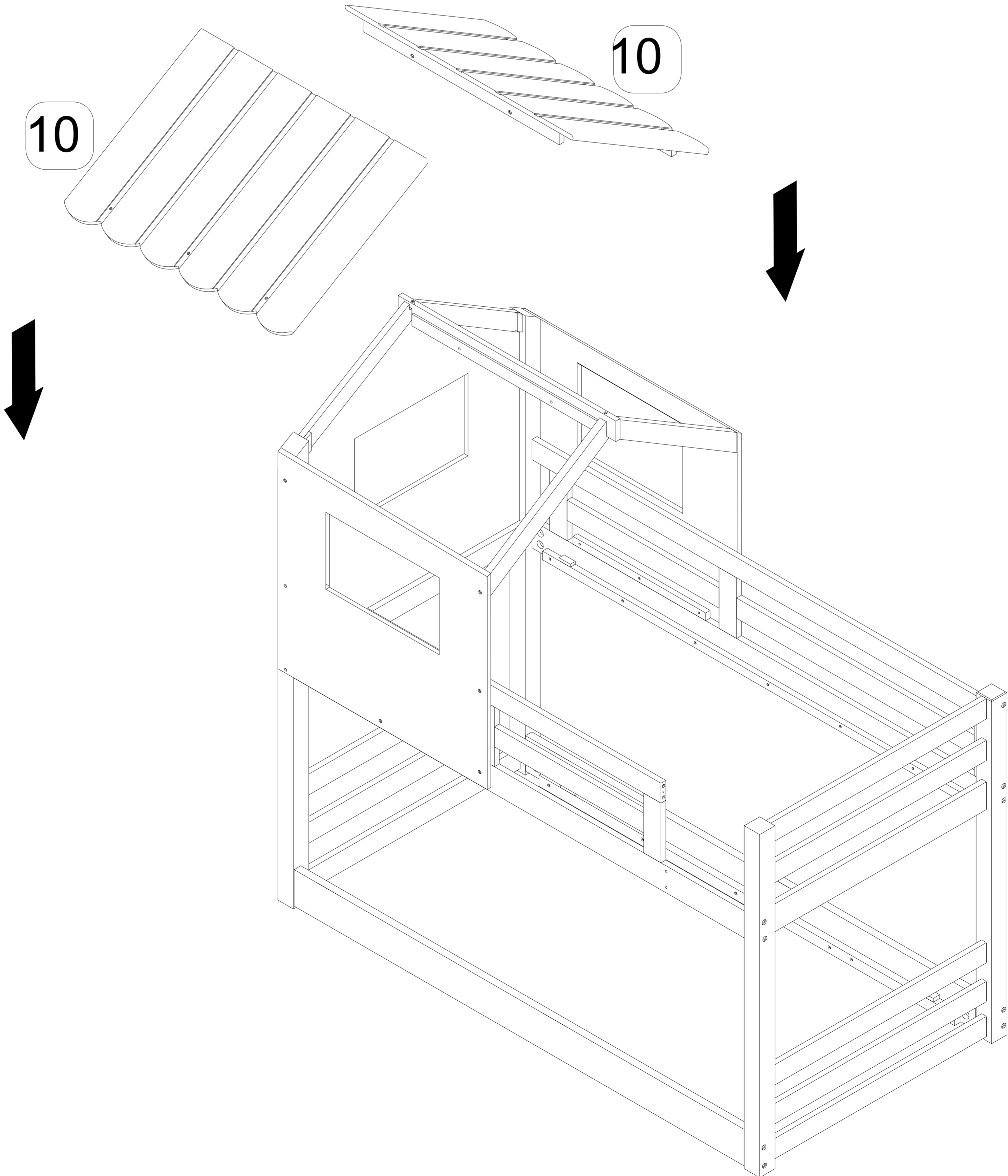

STEP 7: ROOF PANEL ASSEMBLY

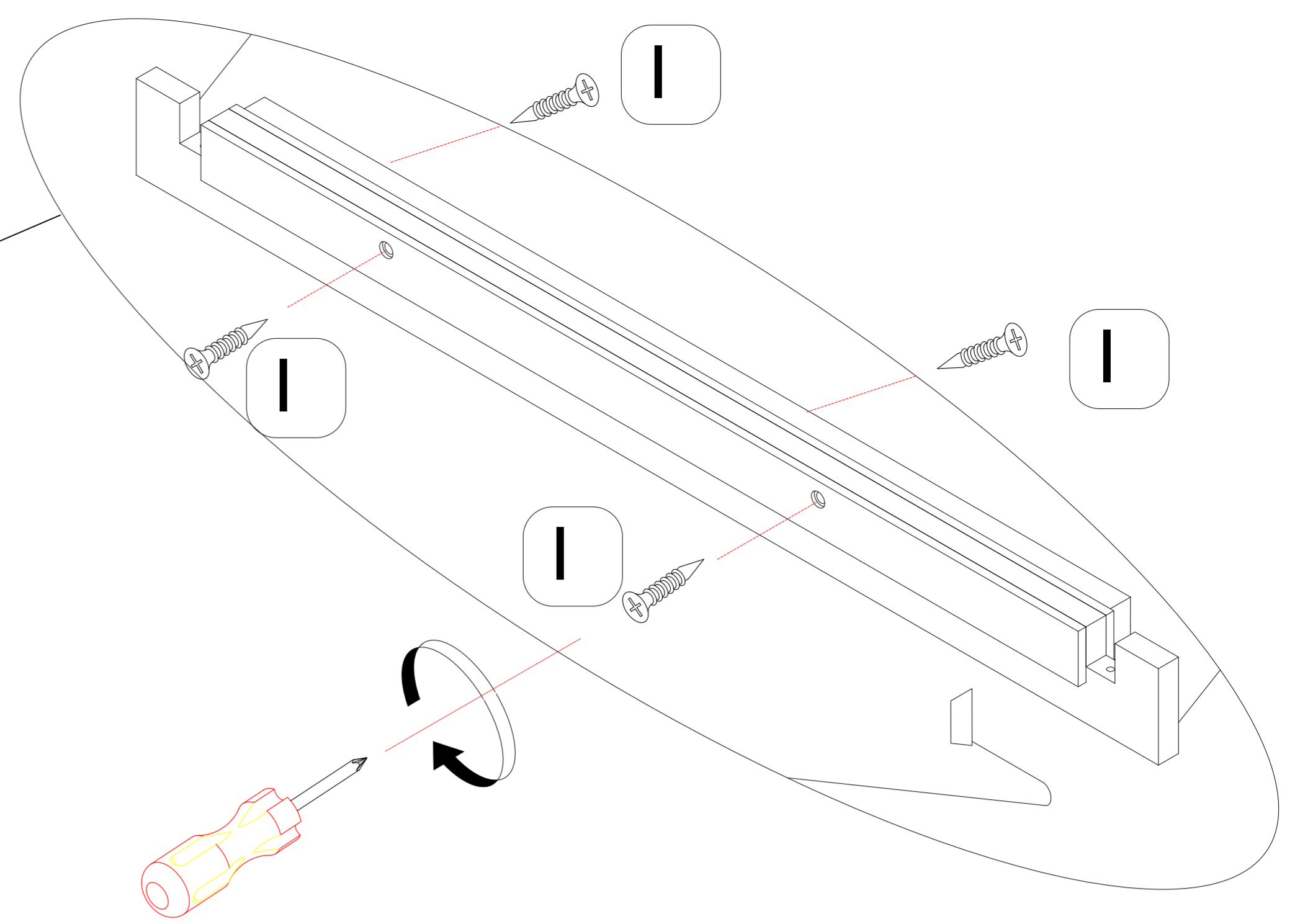
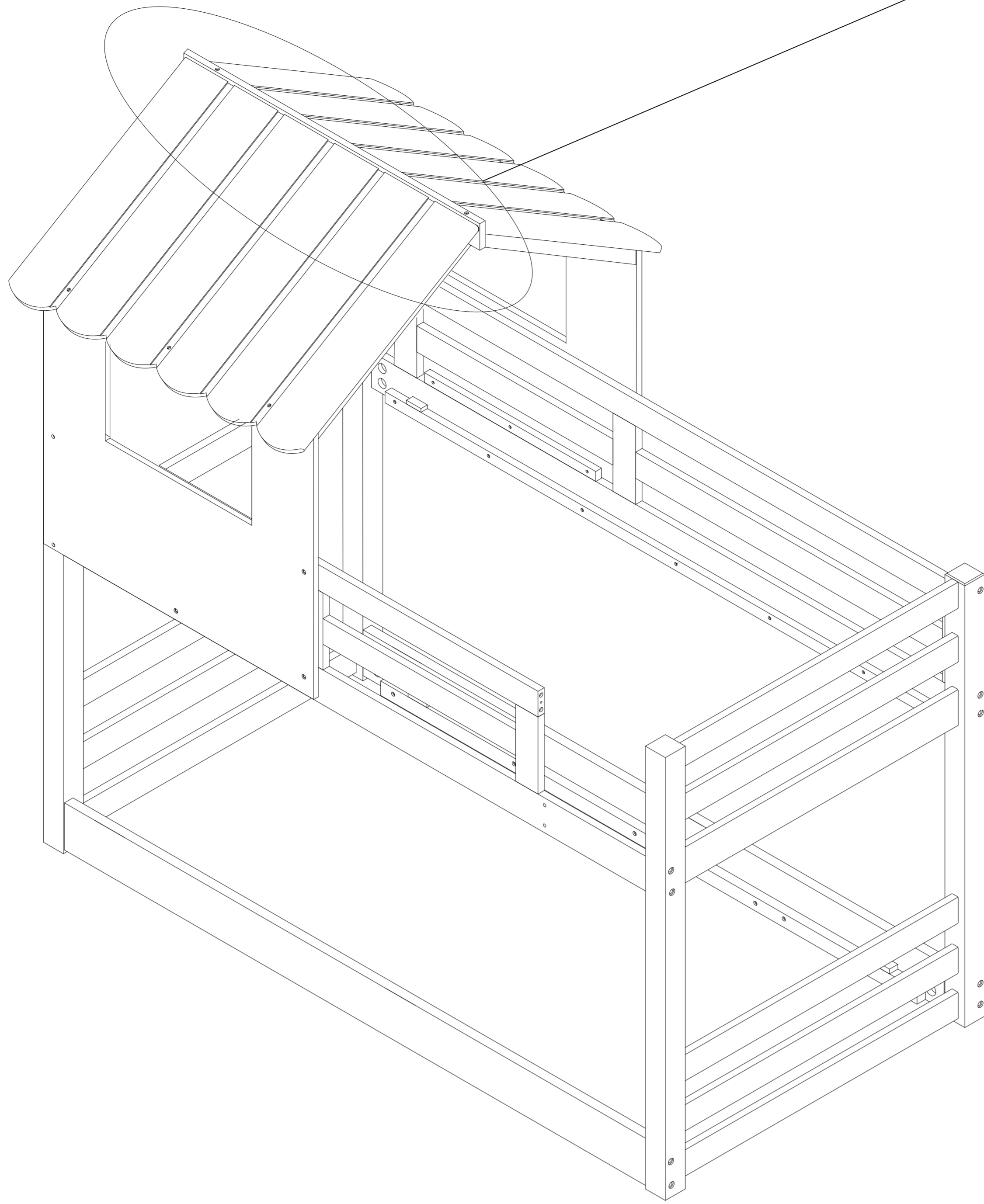

4 PLACES

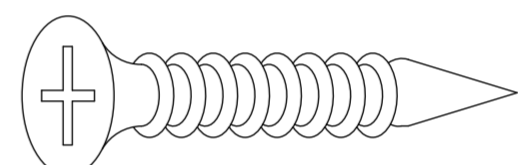
I  **4 pcs**

STEP 8: ROOF PANEL ASSEMBLY

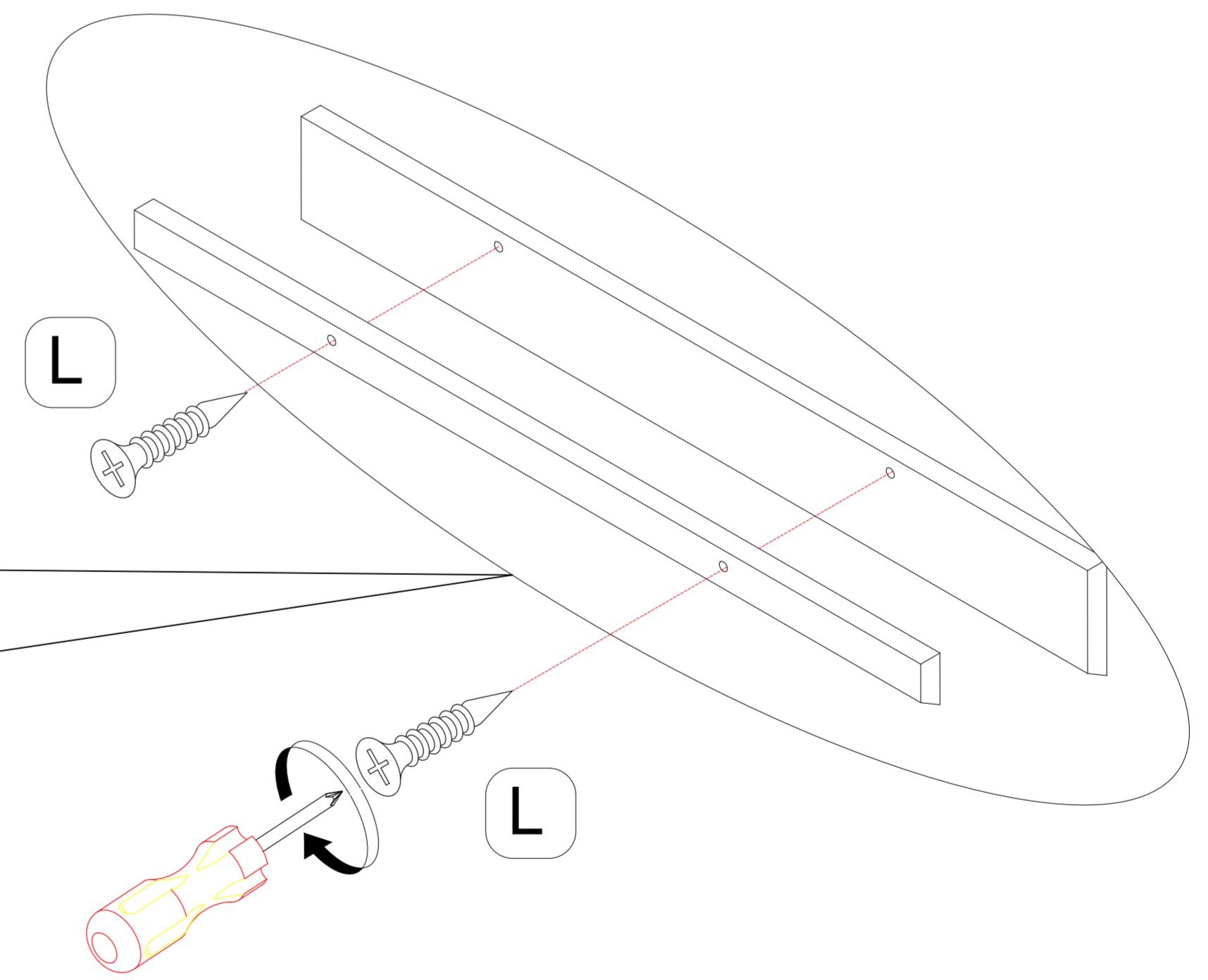
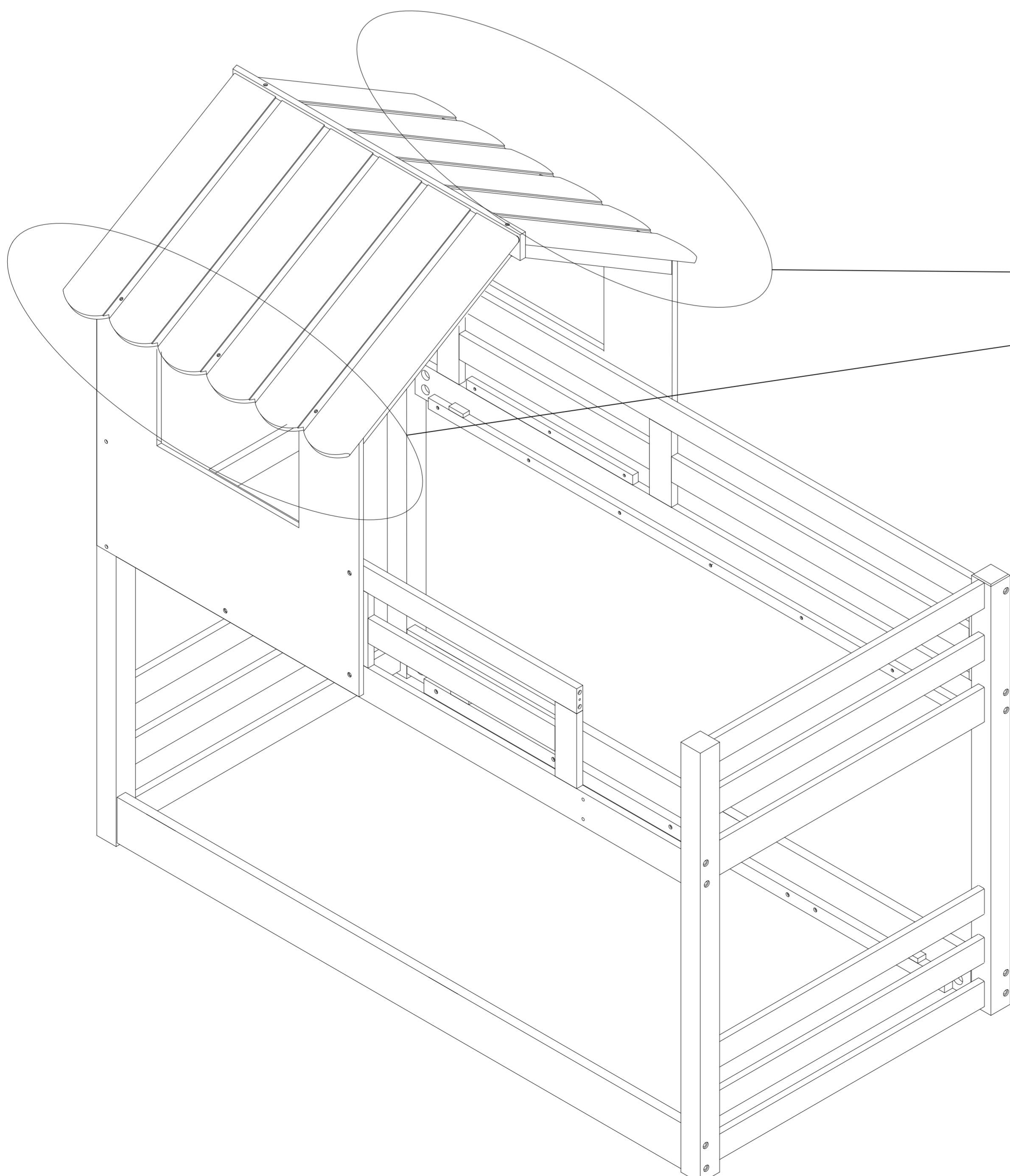

4 PLACES

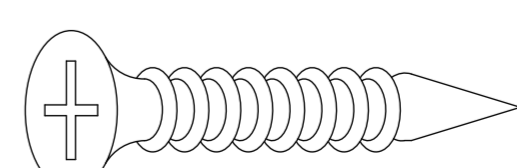
L  **4 pcs**

STEP 9: RIDGE BOARD ASSEMBLY

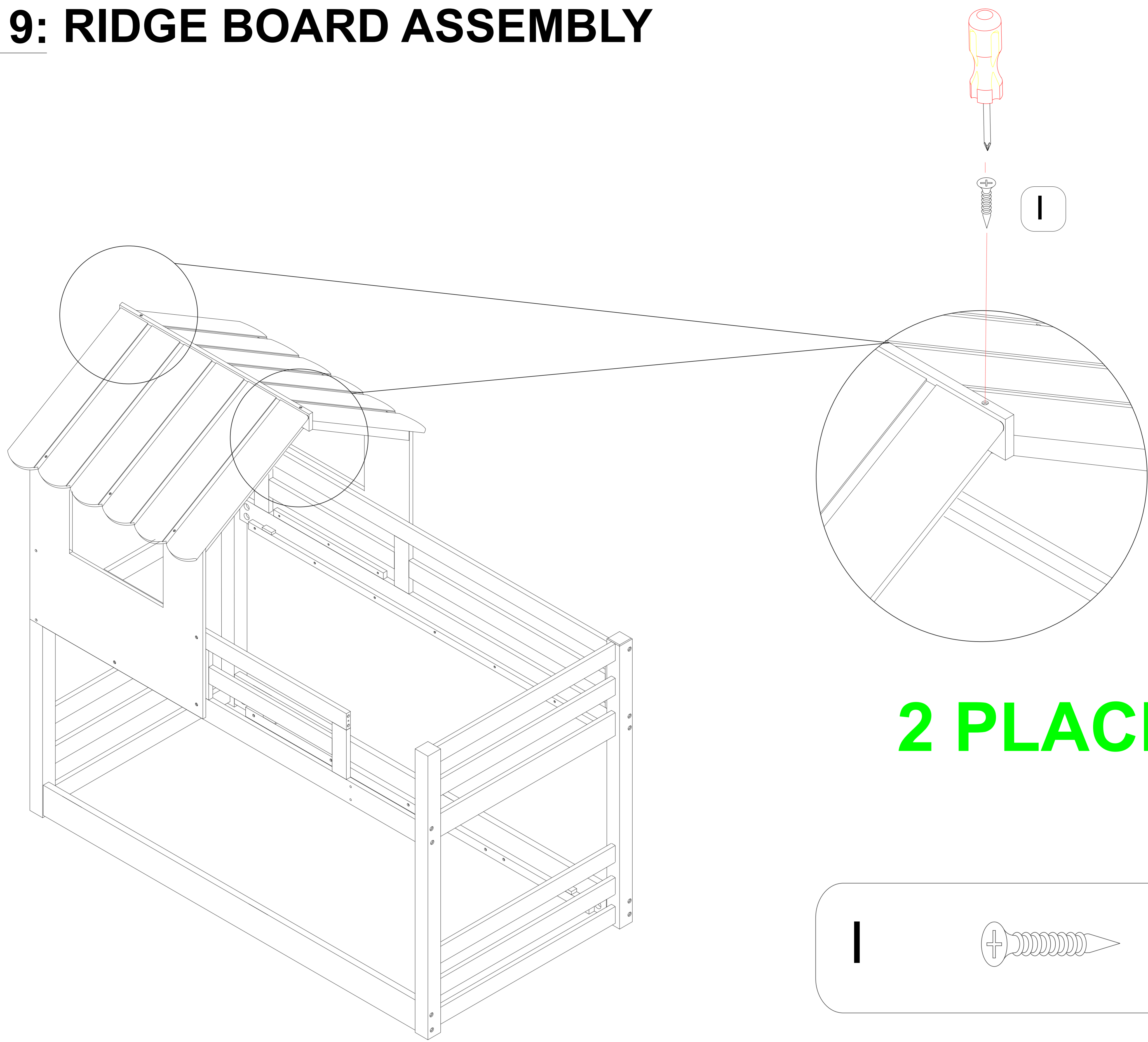

STEP 10: GUARDRAIL ASSEMBLY

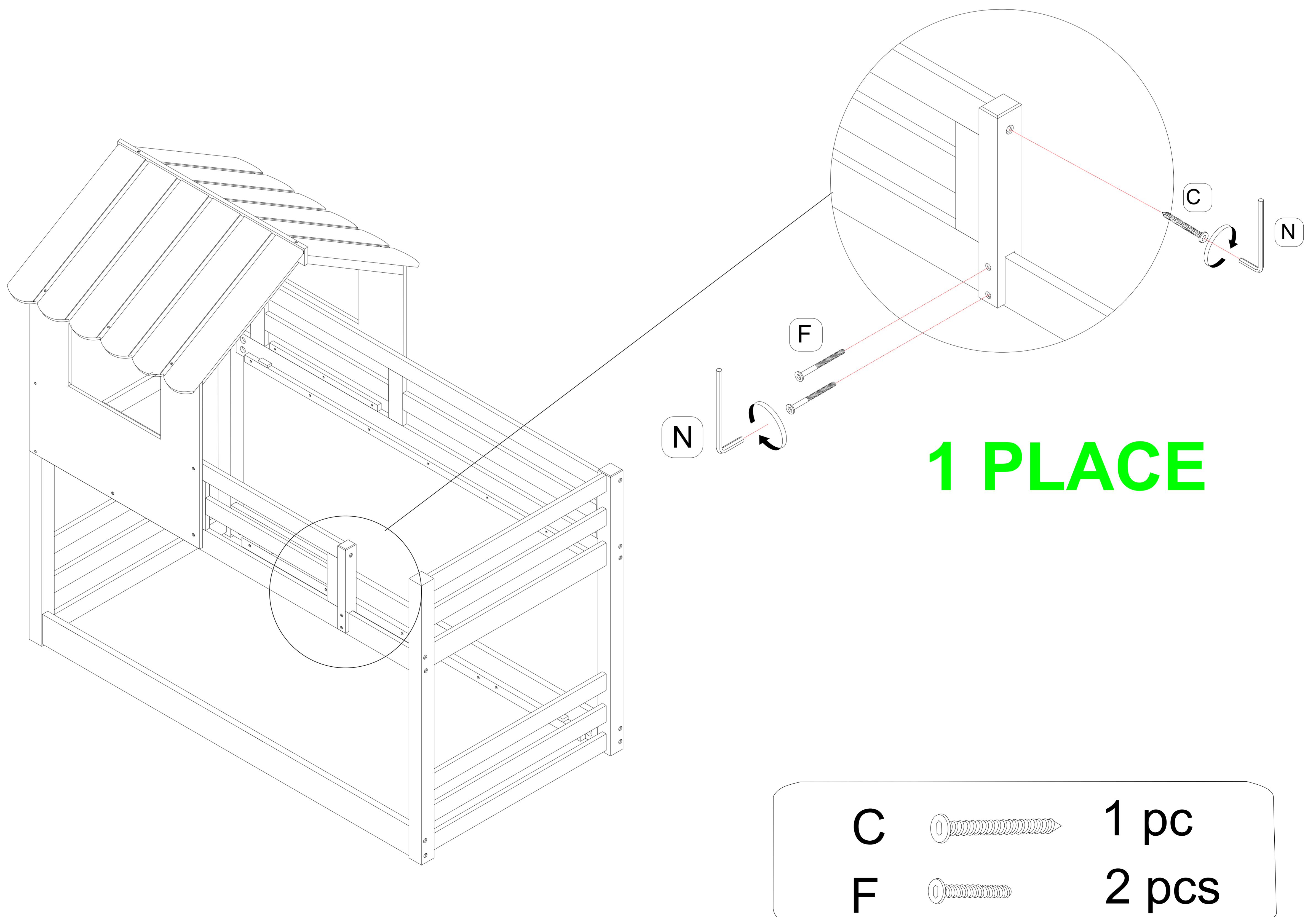

STEP 11: LADDER ASSEMBLY

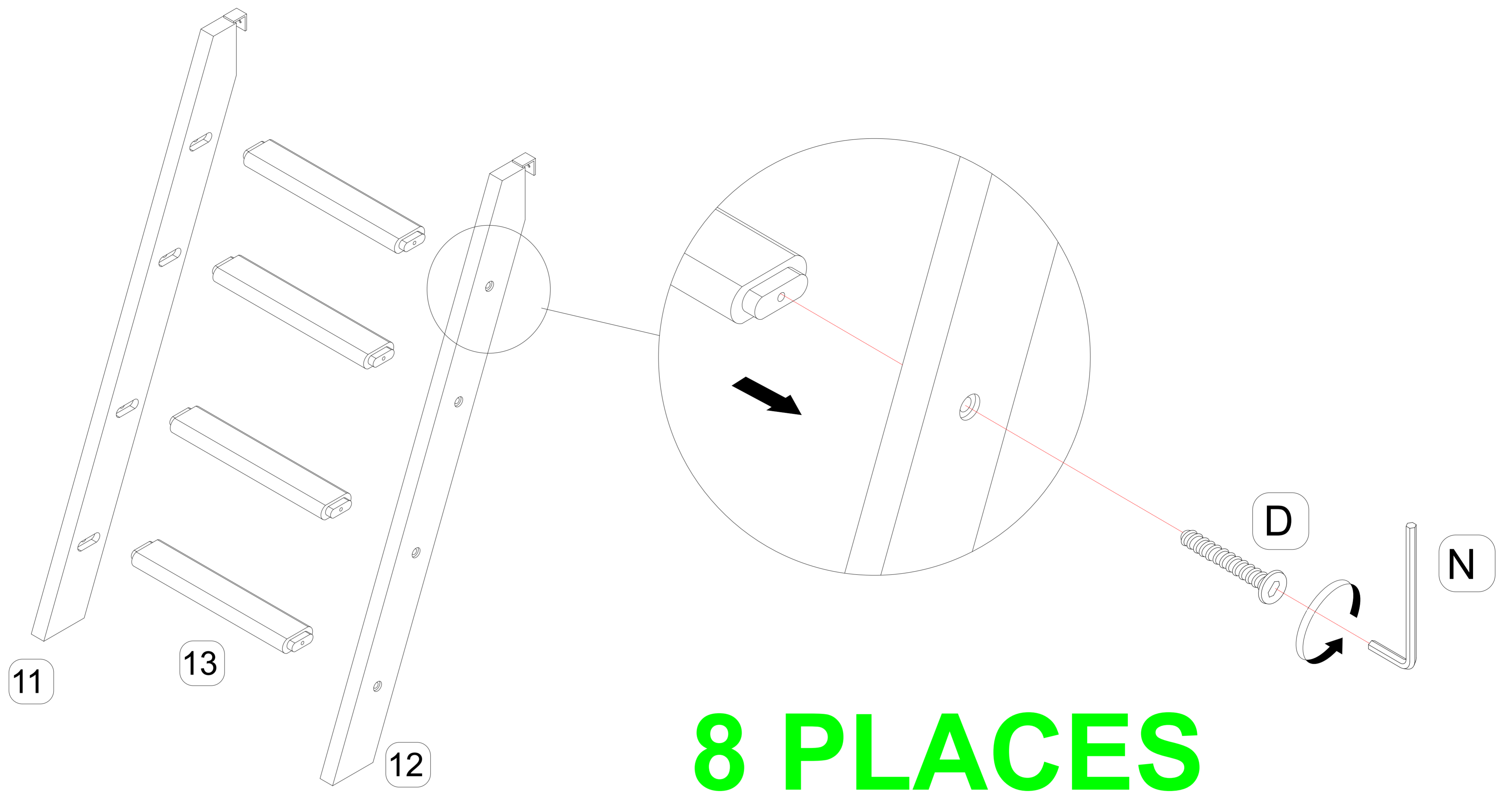

D

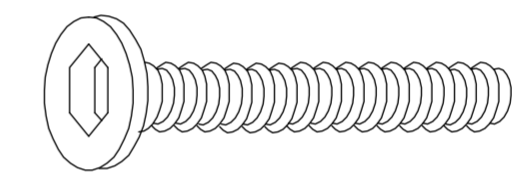

8pcs

STEP 12: LADDER ASSEMBLY

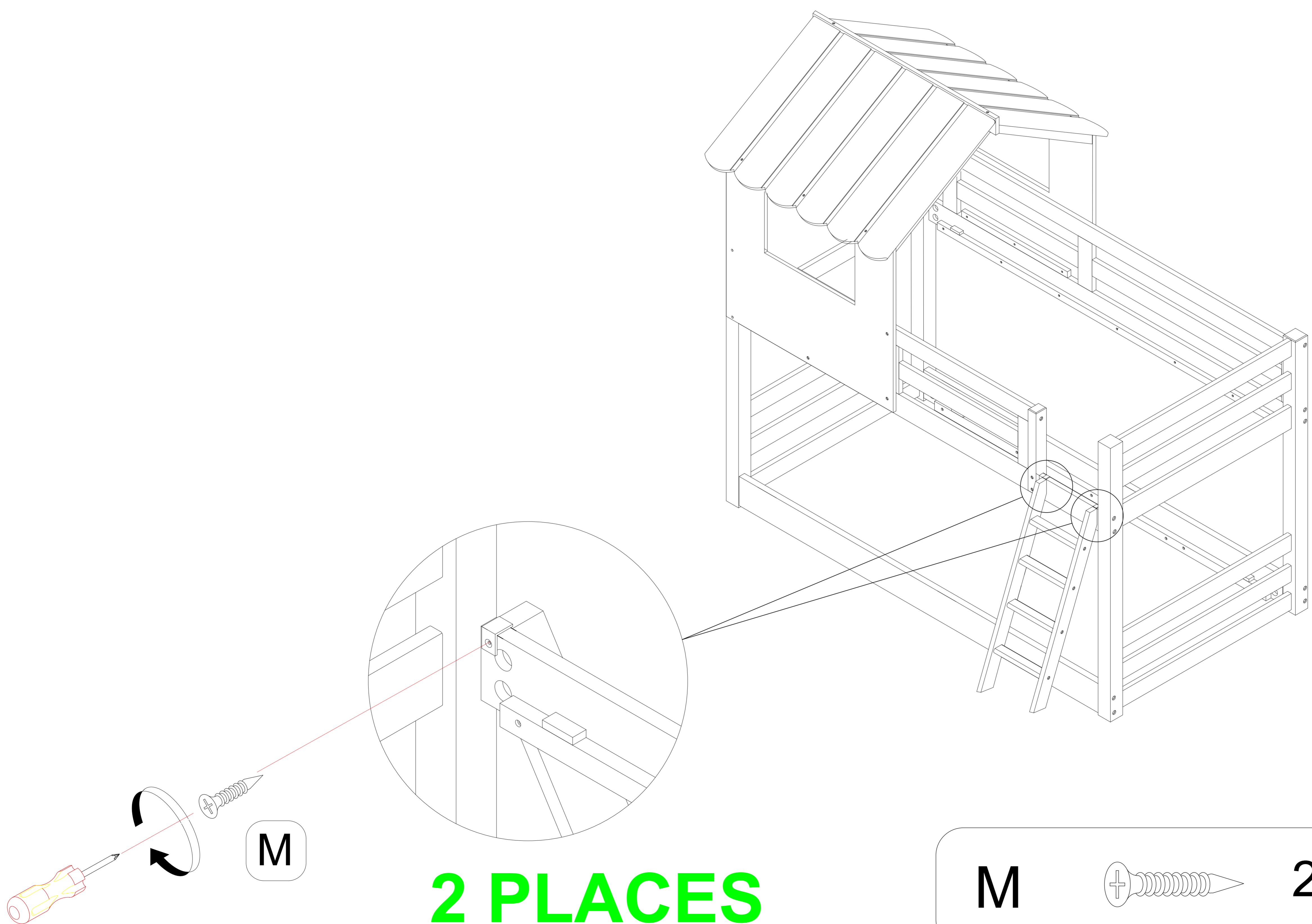

M

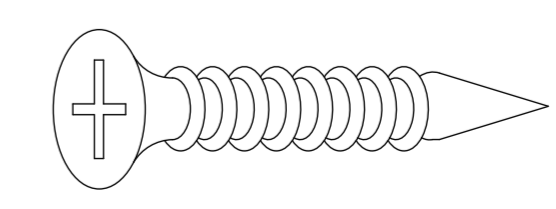

2 pcs

STEP 13: SLATS ASSEMBLY

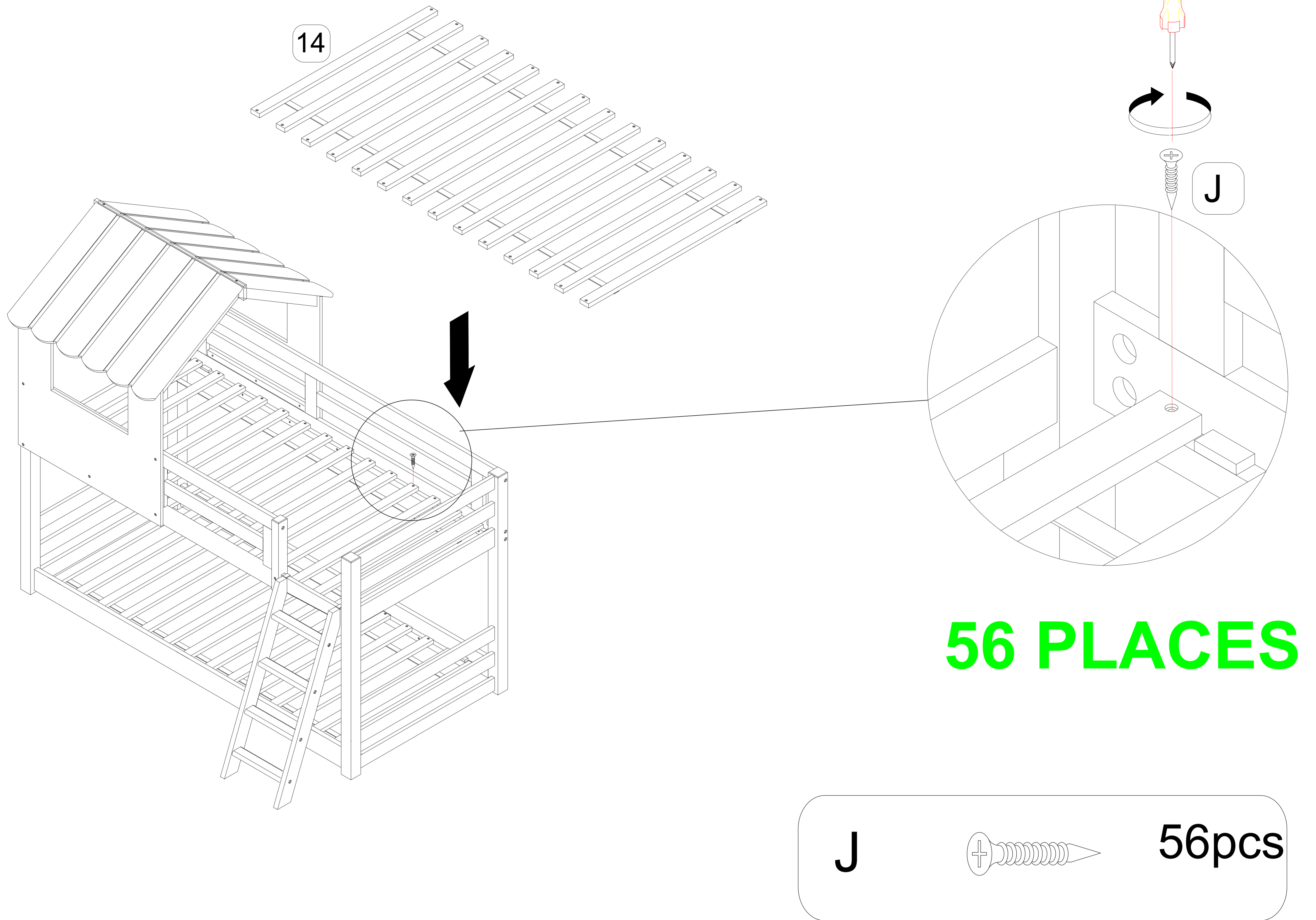

STEP 14: COMPLETED ASSEMBLY

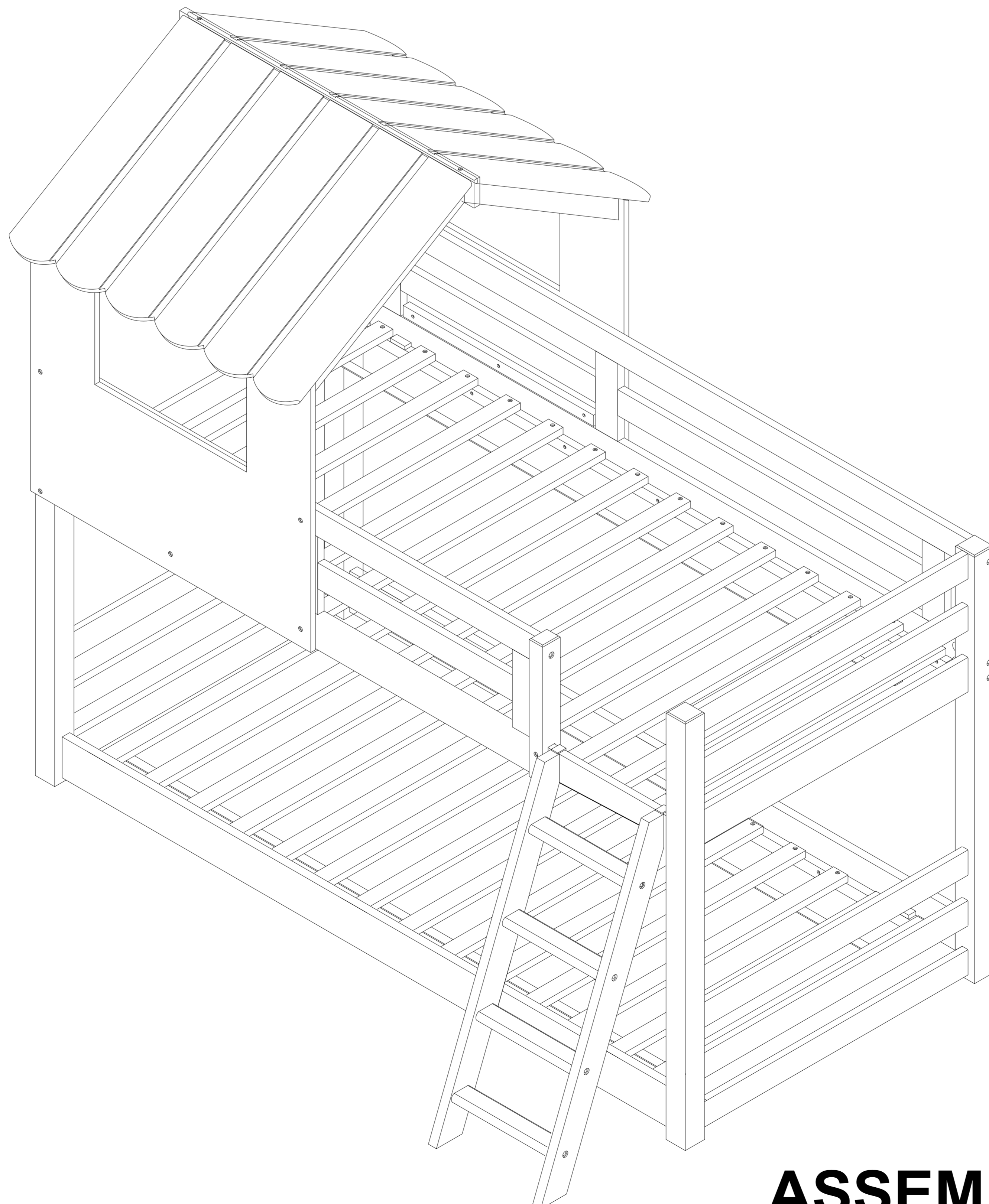

ASSEMBLY IS COMPLETED

WARNING !!!

To help prevent serious or fatal injuries from entrapment or falls:

1. Follow the information on the warning label appearing on the upper bunk end structure and on the carton. Do not remove warning label from bed.
2. Use only mattress which is 39" WIDE AND 75" LONG ON UPPER BUNK.
3. Ensure thickness of upper mattress does not exceed 6" and top surface of mattress is at least 5" below the upper edge of guardrails.
4. Do not allow children under 6 years to use the upper bunk.
5. Periodically check and ensure that the guardrail, ladder, and other components are in their proper position, free from damage, and that all connectors are tight.
6. Do not allow horseplay on or under the bed and prohibit jumping on the bed.
7. Always use ladder for entering and leaving upper bunk.
8. Do not use substitute parts. Contact the manufacturer or dealer for replacement parts.
9. Use of a night-light may provide added safety precaution for a child using the upper bunk.
10. Always use guardrails on both long sides of the upper bunk. If the bunk bed will be placed next to a-wall, the guardrail that runs the full length of the bed should be placed against the wall to prevent entrapment between the bed and the wall.
11. The use of water or sleep flotation mattresses is prohibited.

STRANGULATION HAZARD:

12. Never attach or hang items to any part of the bunk bed that are not designed for use with the bed, for example, but not limited to, hooks, belts and jump ropes.
13. Prohibit more than one person on upper bunk.
14. Maximum total weight not to exceed-150 lbs on the upper bunk, and maximum 200 lbs on lower bunk.
15. Keep these instructions for future reference.