

ITEM NO : COFFE TABLE / TABLE BASSE

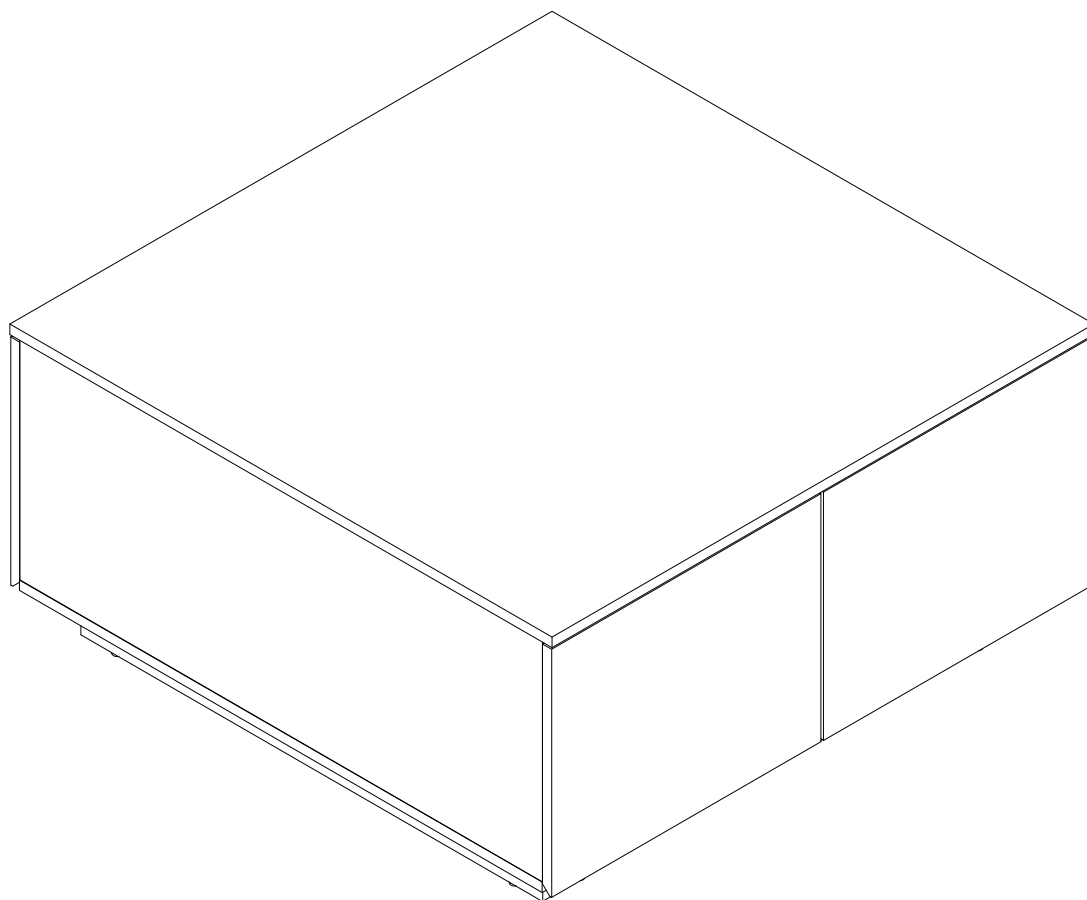

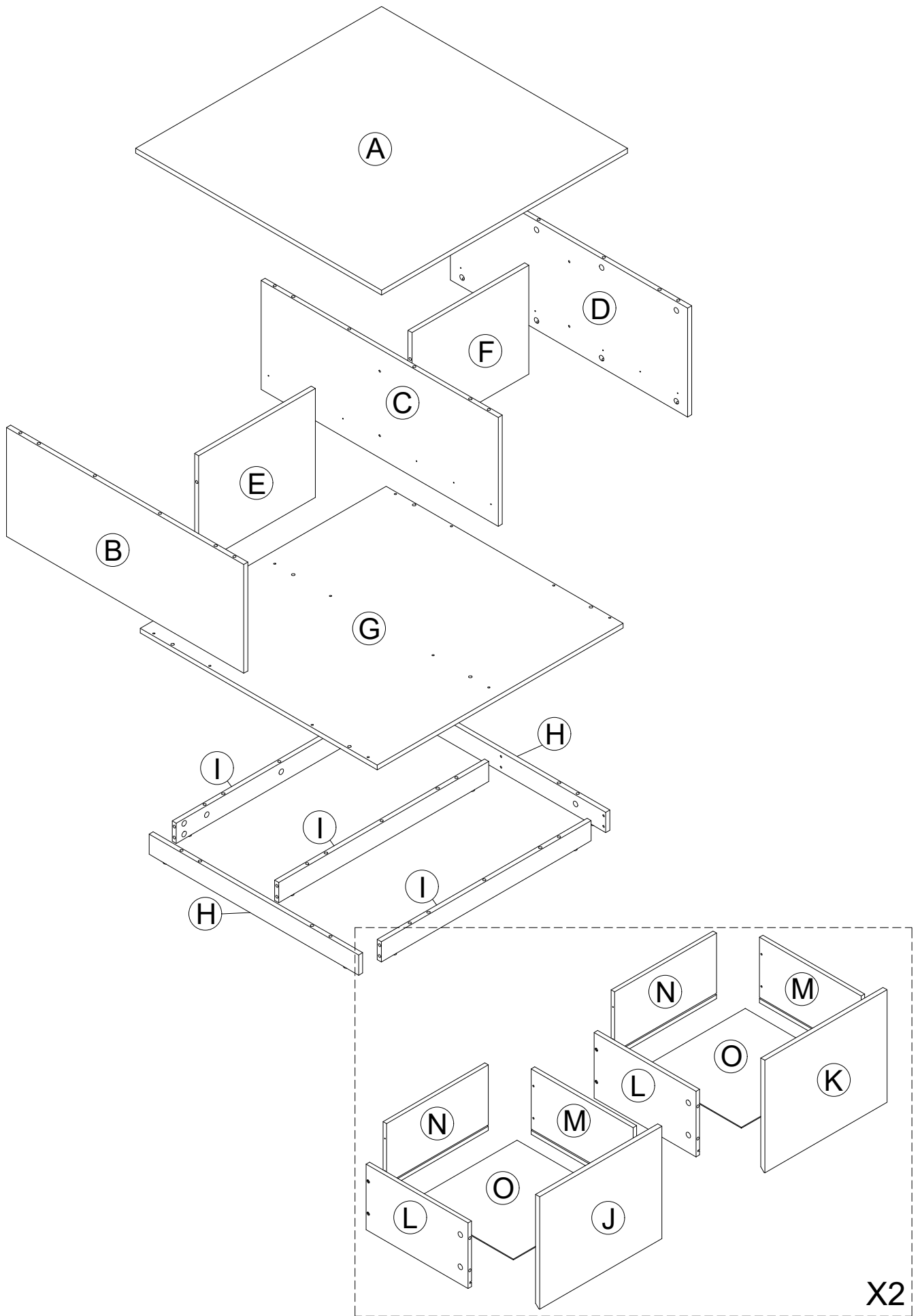

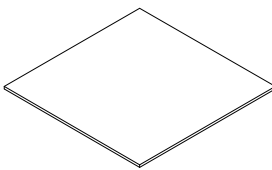
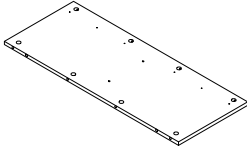
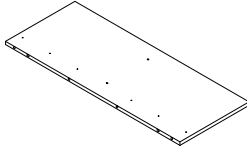
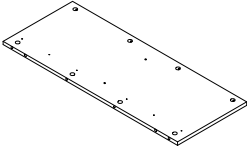
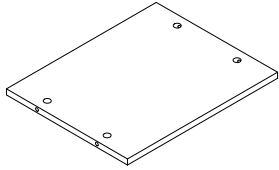
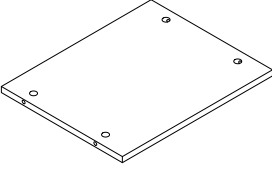
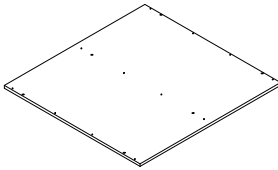
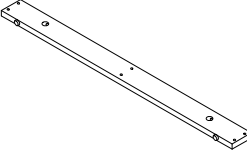
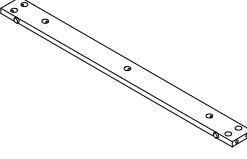
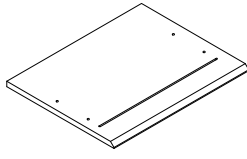
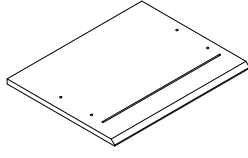
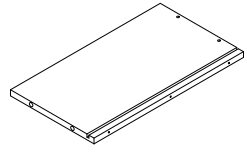
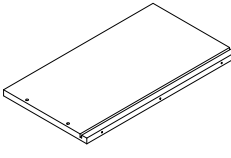
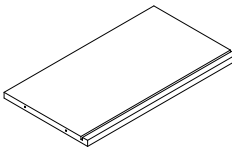
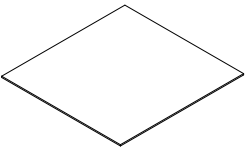

PRODUCT PARTS:PIÈCES DU PRODUIT:

A	B	C	D	E
				
1 PC	1 PC	1 PC	1 PC	1 PC
F	G	H	I	J
				
1 PC	1 PC	2 PCS	3 PCS	2 PCS
K	L	M	N	O
				
2 PCS	4 PCS	4 PCS	4 PCS	4 PCS

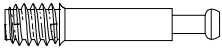
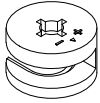
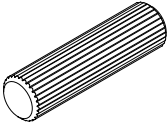
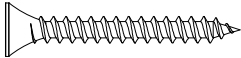
HARDWARE: MATÉRIEL:

①	②	③	④	⑤
 Ø6x33mm	 Ø15x9.5mm	 Ø8x30mm	 Ø4x30mm	 Ø3.5x12mm
73+3 PCS	73+3 PCS	22+1 PCS	16 PCS	48+2 PCS

⑥

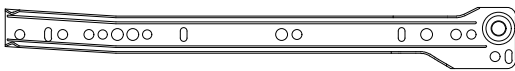

CL=1

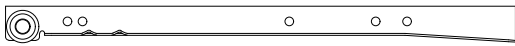

DL=1

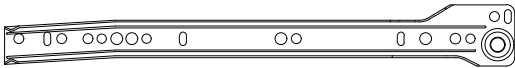

CR=1



DR=1

L350mm

4 SET

STEP:ÉTAPE 1

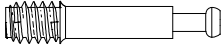
1  12pcs
Ø6x33mm

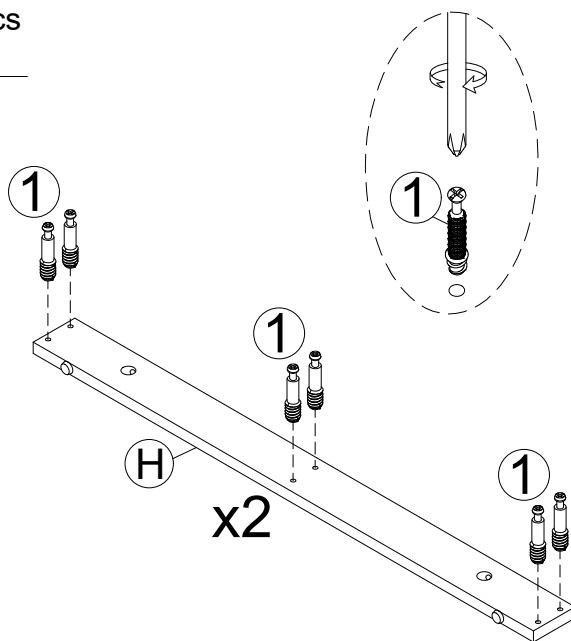
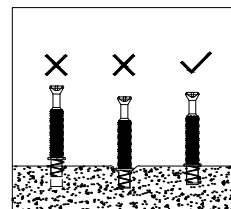

Step 2

2  12pcs
Ø15x9.5mm

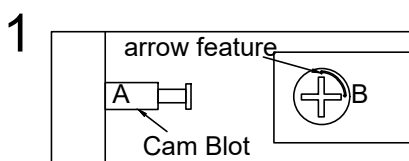
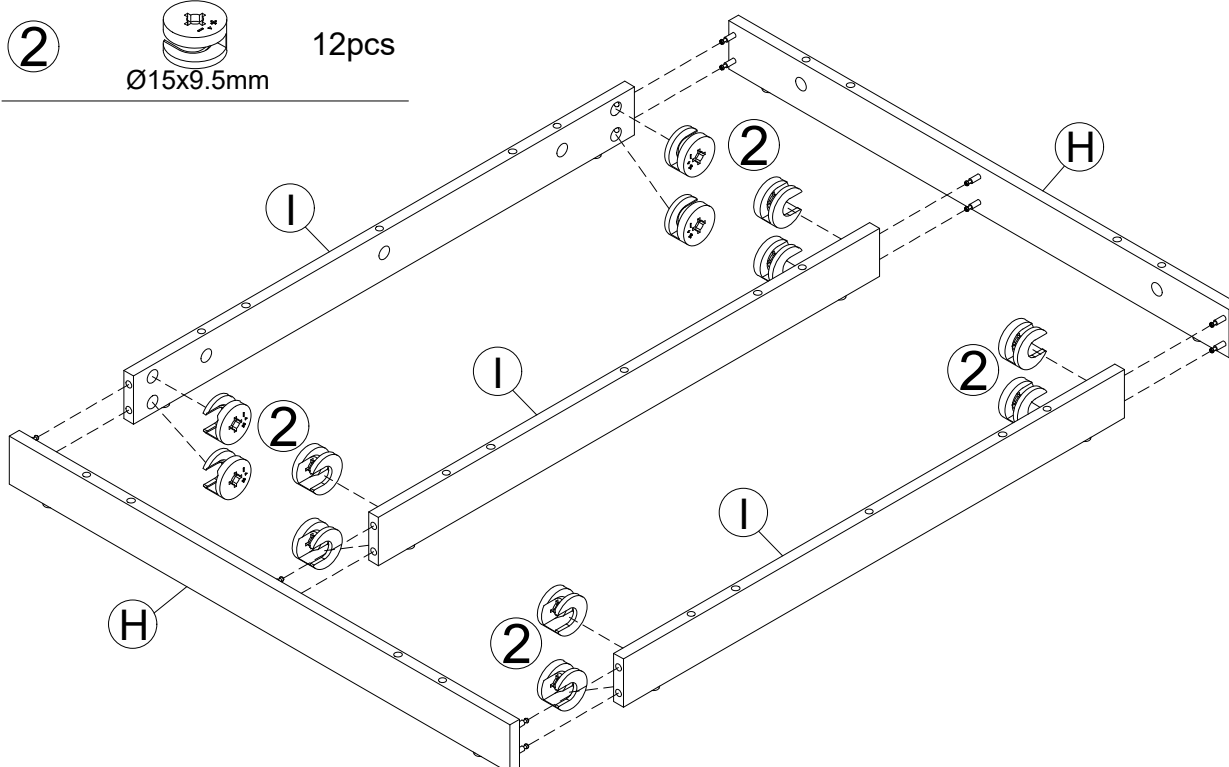

- Make sure arrow feature on Cam (B) points to Cam bolt (A)
- Assurez-vous que la flèche sur la came (B) pointe vers le boulon à came (A)

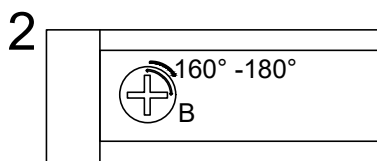

- Rotate cam (B) clockwise 160°-180° to lock parts together.
- Tournez la came (B) dans le sens des aiguilles d'une montre de 160° à 180° afin de verrouiller les pièces ensemble.

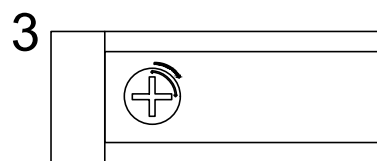

- Parts should be tight against each other and connection should be rigid
- Les pièces doivent être bien serrées l'une contre l'autre et la connexion doit être rigide.

STEP:ÉTAPE 3

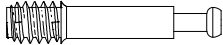
1  13pcs
Ø6x33mm

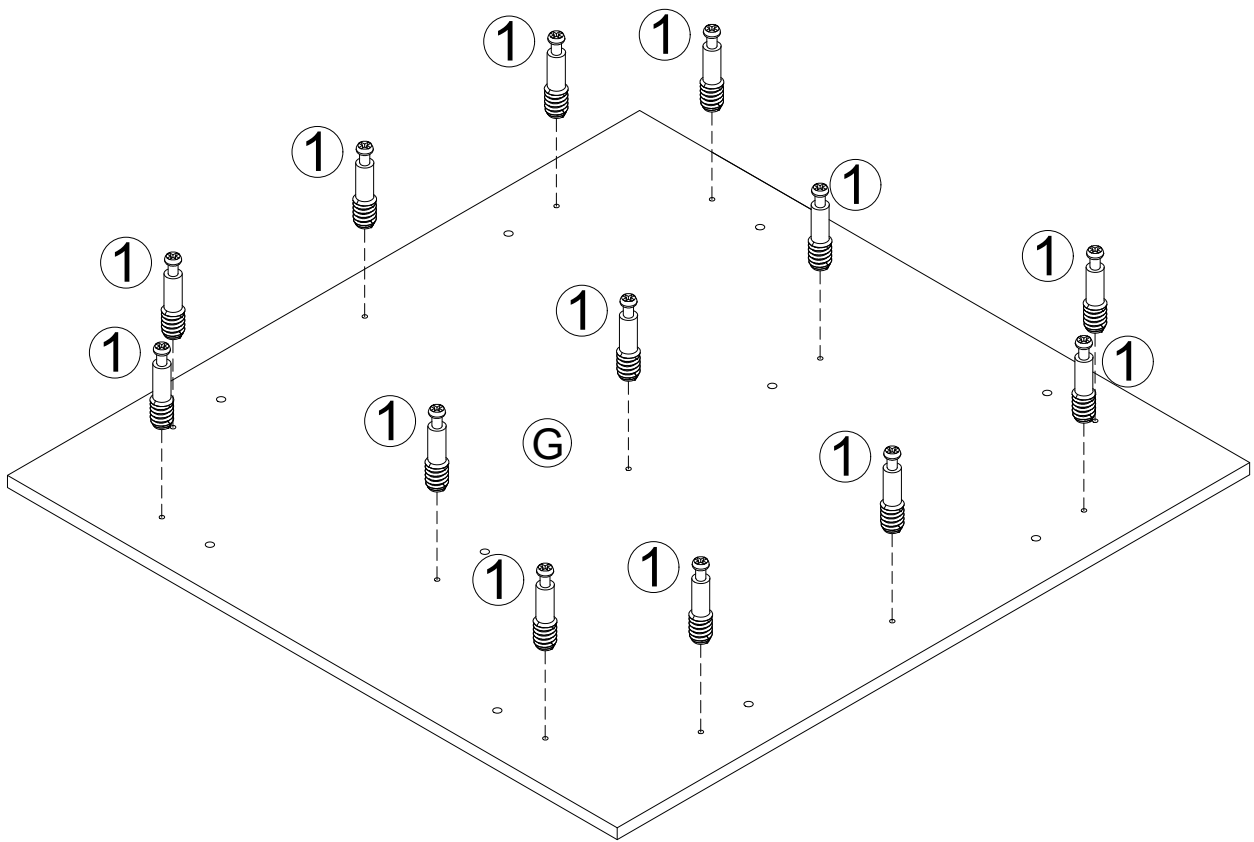

STEP:ÉTAPE 4

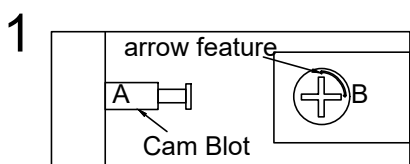
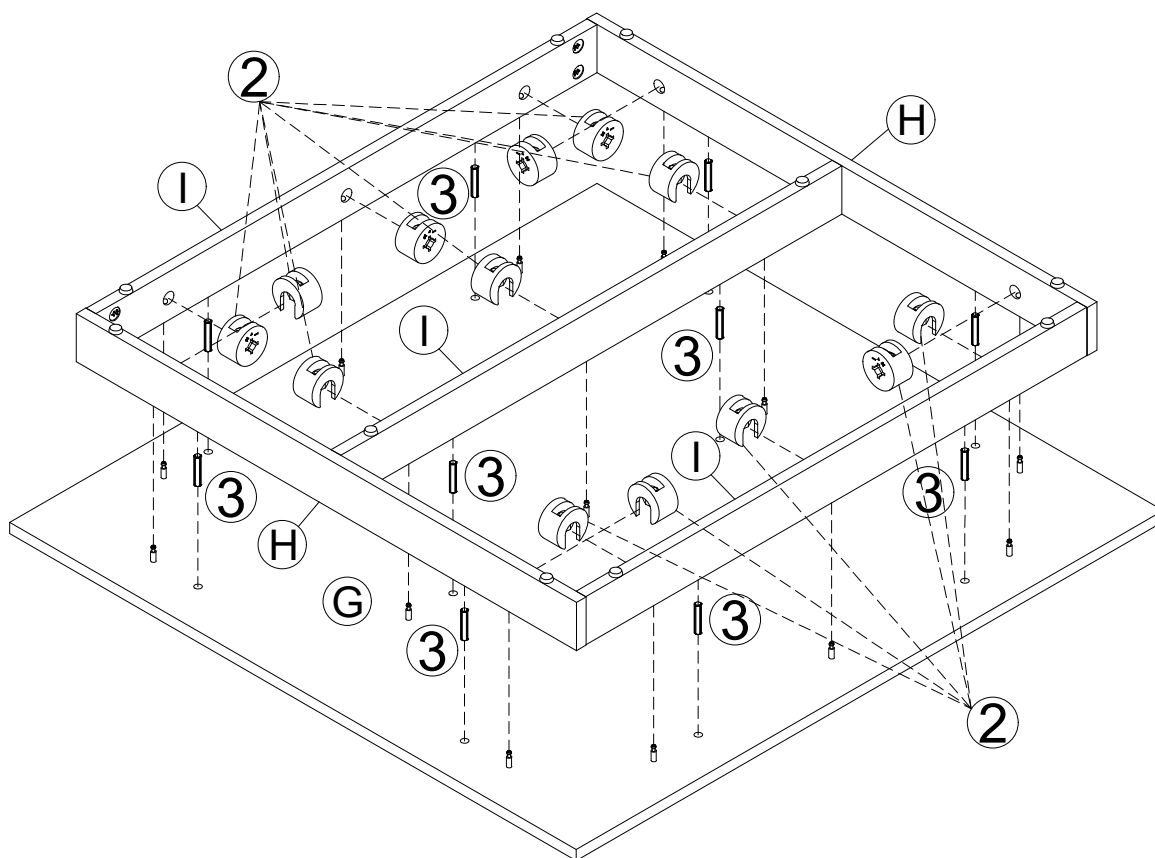

- Make sure arrow feature on Cam (B) points to Cam bolt (A)
- Assurez-vous que la flèche sur la came (B) pointe vers le boulon à came (A)

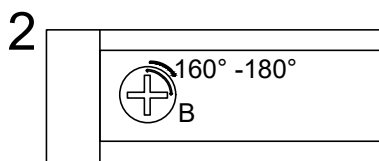

- Rotate cam (B) clockwise 160°-180° to lock parts together.
- Tournez la came (B) dans le sens des aiguilles d'une montre de 160° à 180° afin de verrouiller les pièces ensemble.

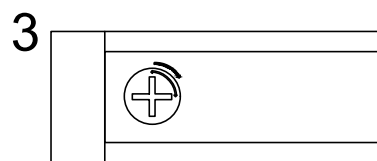

- Parts should be tight against each other and connection should be rigid
- Les pièces doivent être bien serrées l'une contre l'autre et la connexion doit être rigide.

STEP:ÉTAPE 5

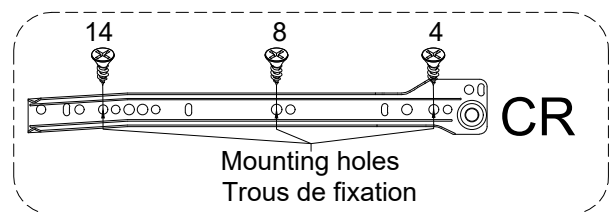
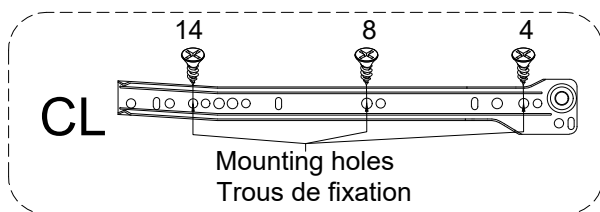
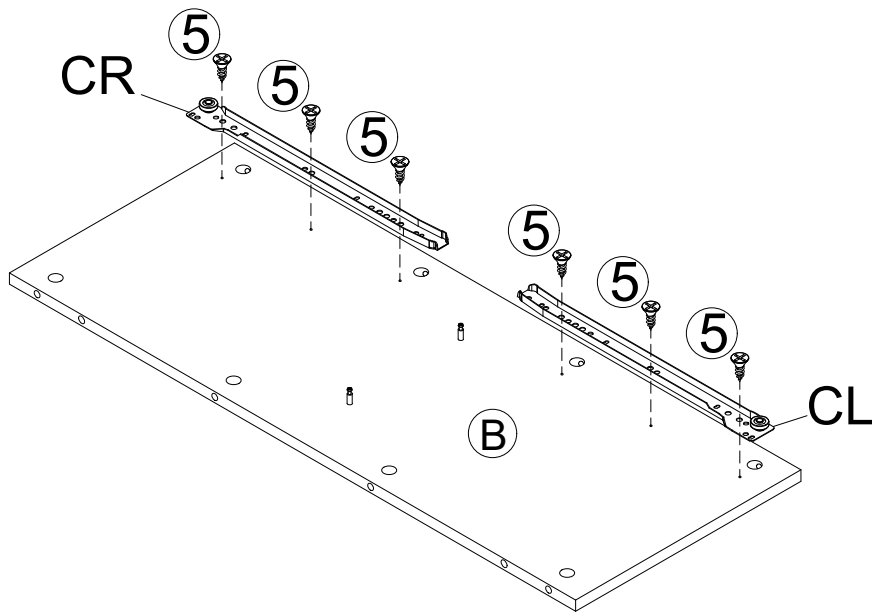
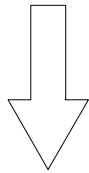
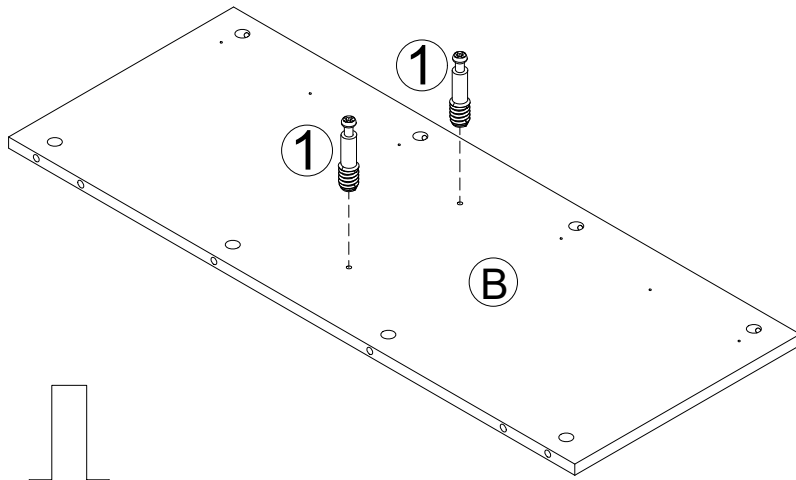
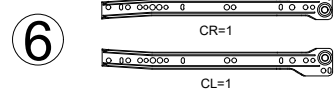
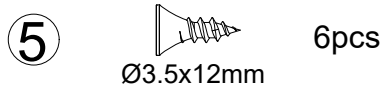
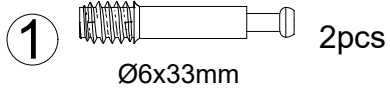

STEP:ÉTAPE 6

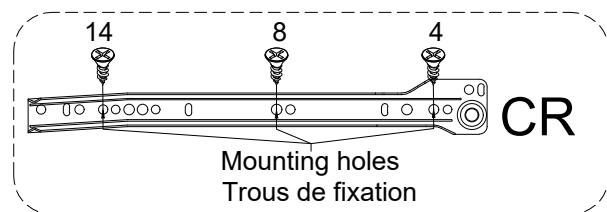
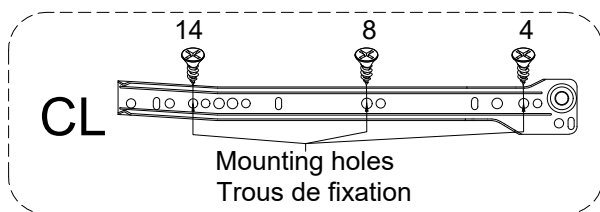
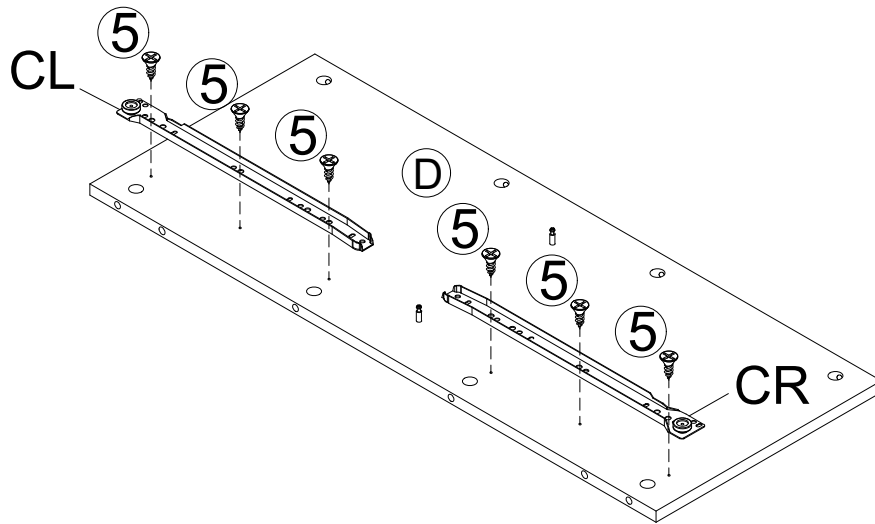
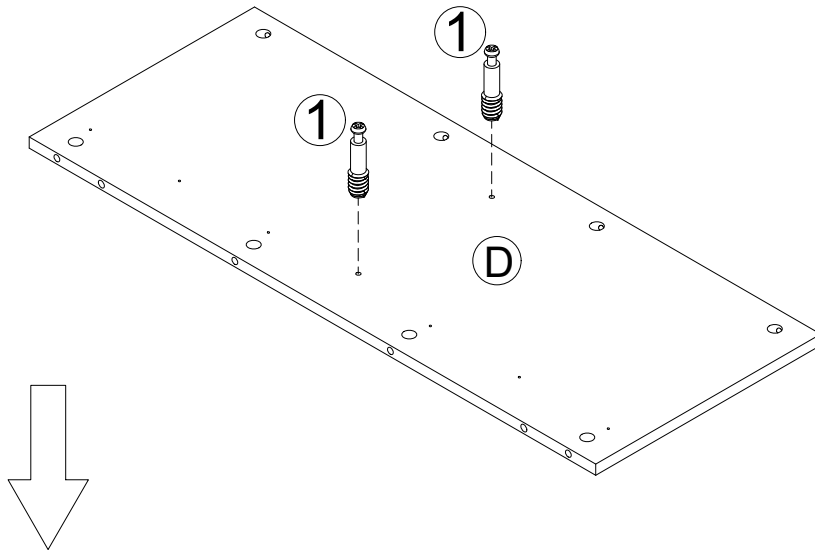
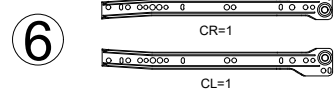
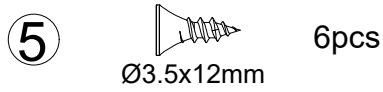
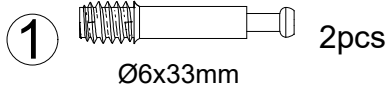

STEP:ÉTAPE 7

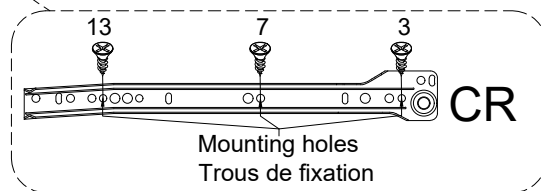
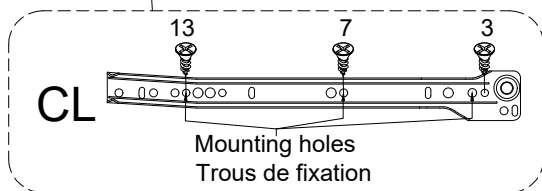
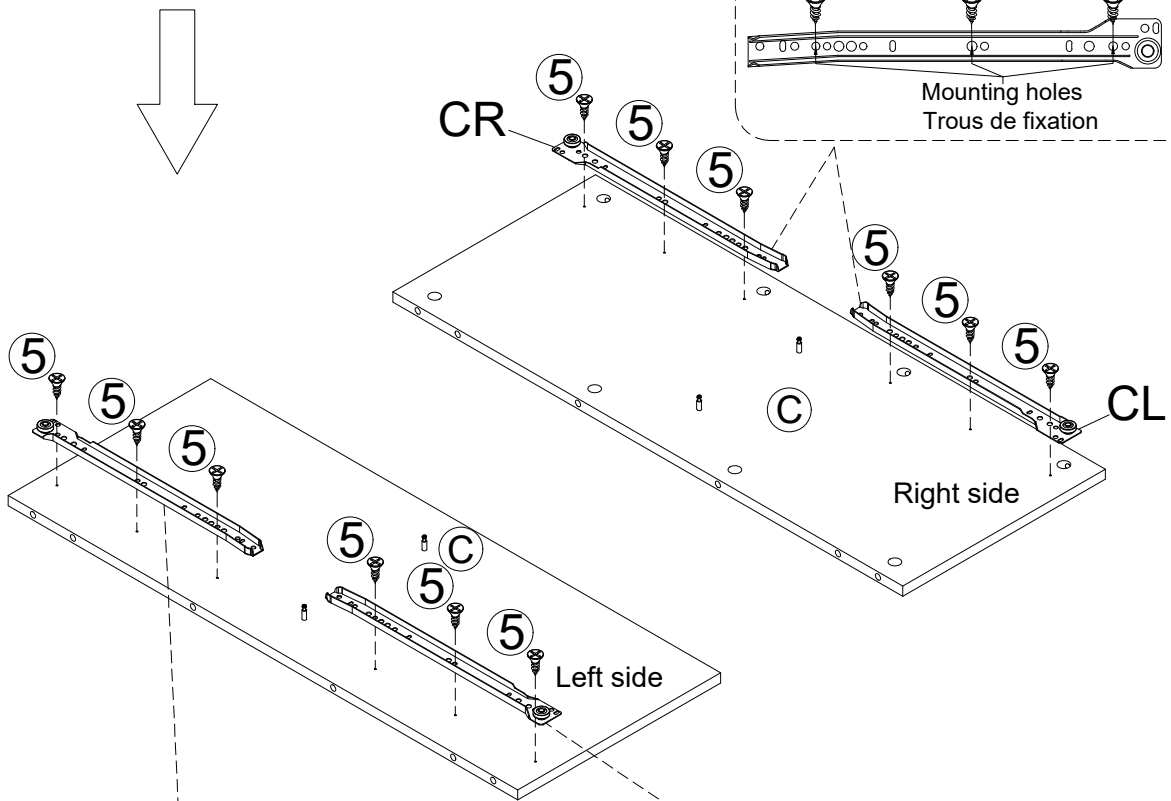
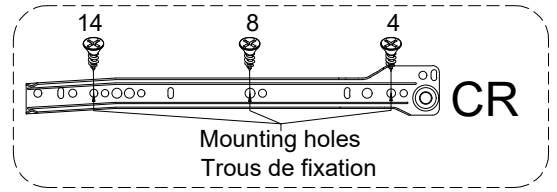
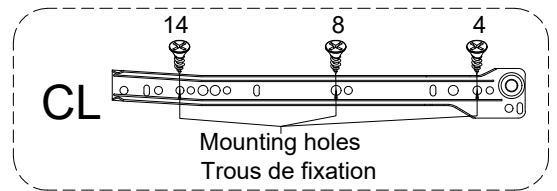
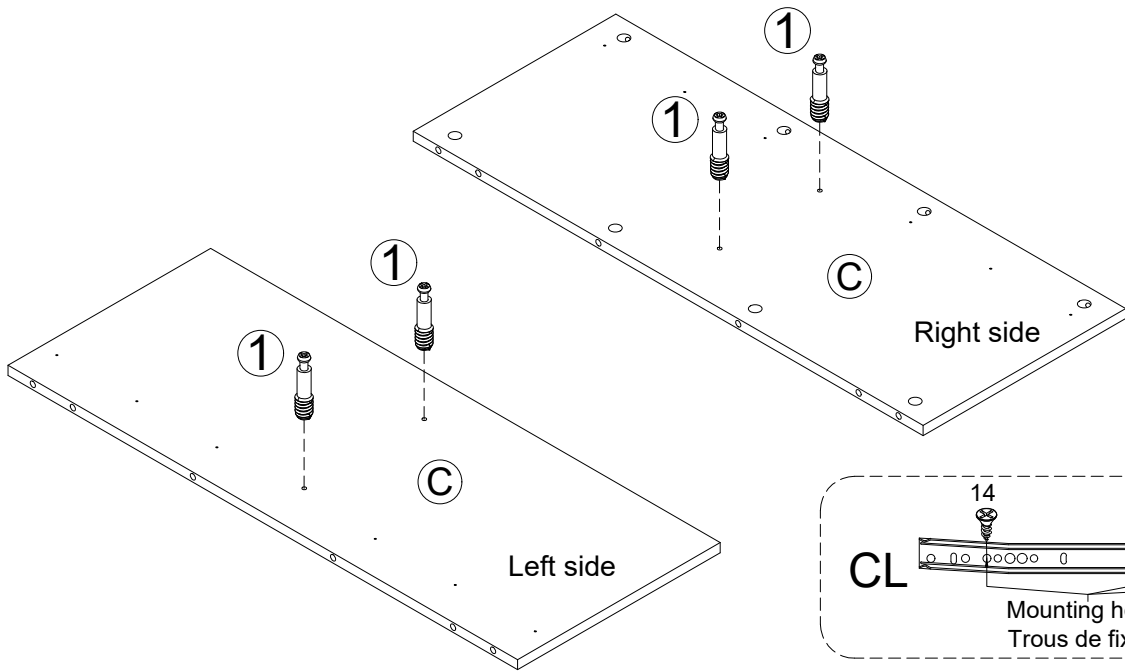
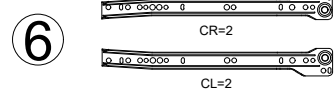
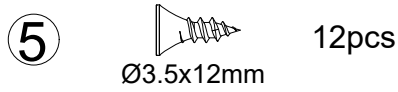
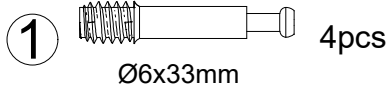

STEP:ÉTAPE 8

2



8pcs

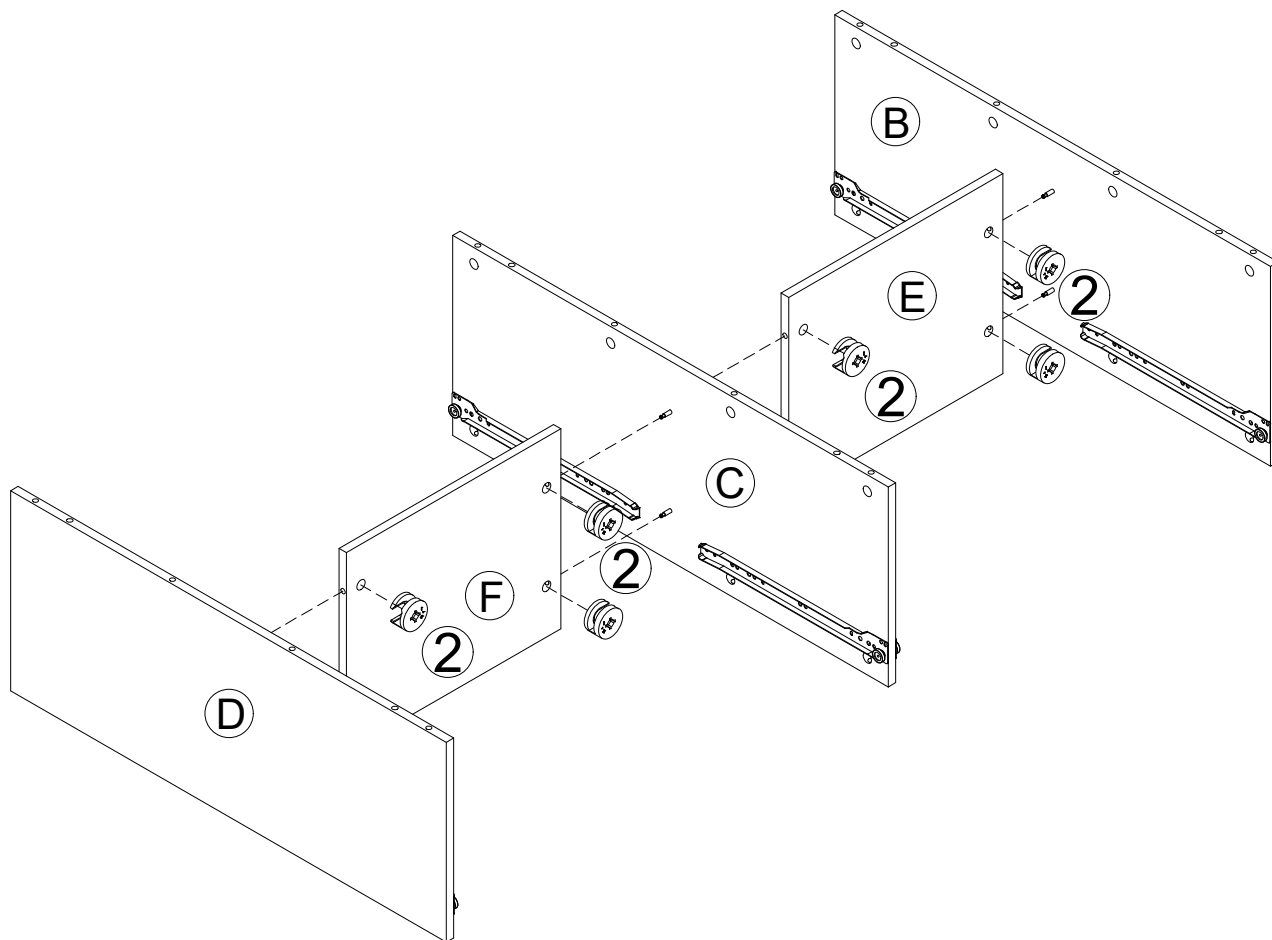

1

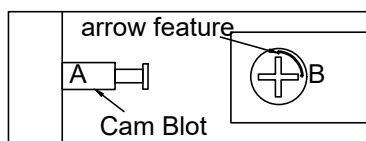

- Make sure arrow feature on Cam (B) points to Cam bolt (A)
- Assurez-vous que la flèche sur la came (B) pointe vers le boulon à came (A)

2

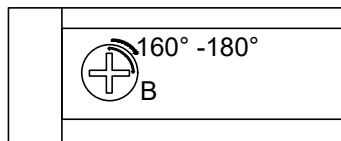

- Rotate cam (B) clockwise 160°-180° to lock parts together.
- Tournez la came (B) dans le sens des aiguilles d'une montre de 160° à 180° afin de verrouiller les pièces ensemble.

3

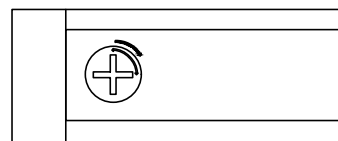

- Parts should be tight against each other and connection should be rigid
- Les pièces doivent être bien serrées l'une contre l'autre et la connexion doit être rigide.

STEP: ÉTAPE 9

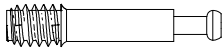
1  12pcs
Ø6x33mm

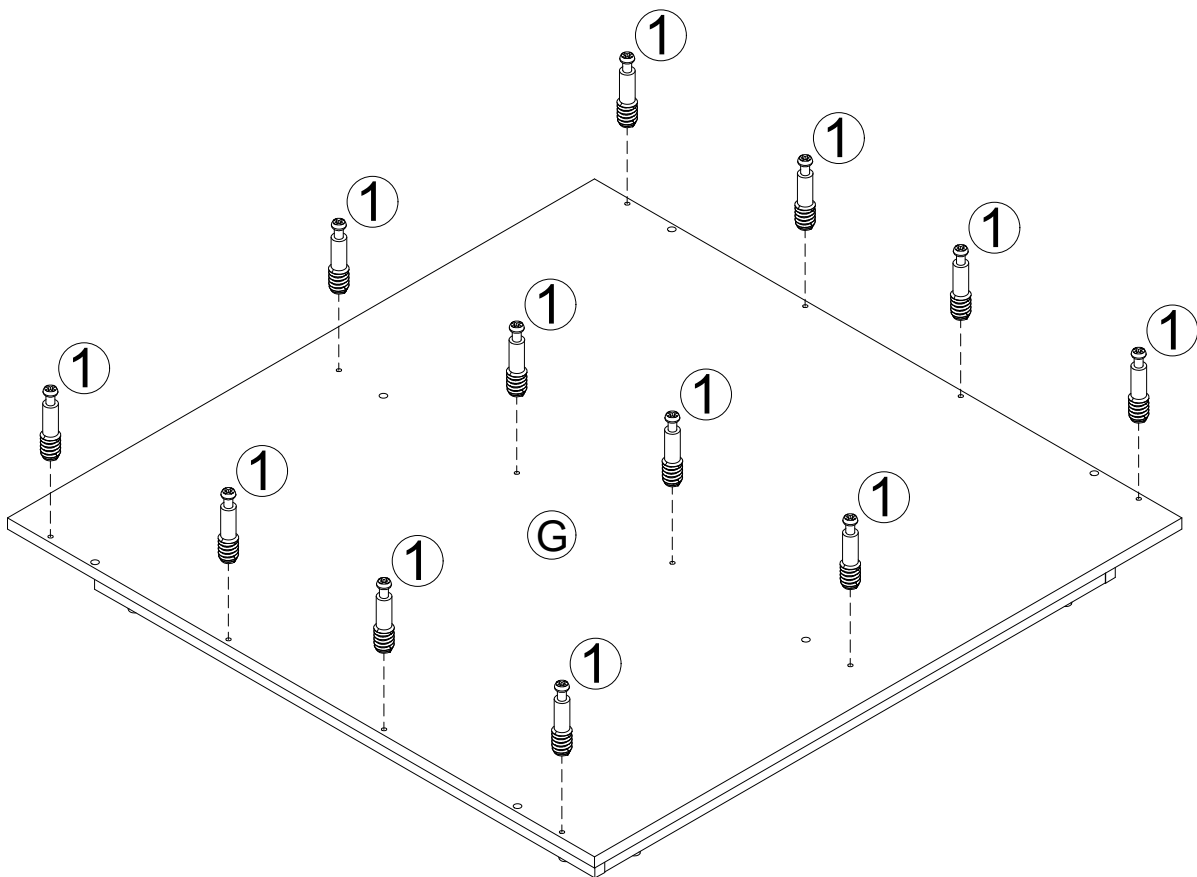

STEP:ÉTAPE 10

②  12pcs
Ø15x9.5mm

③  6pcs
Ø8x30mm

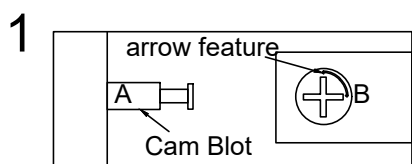
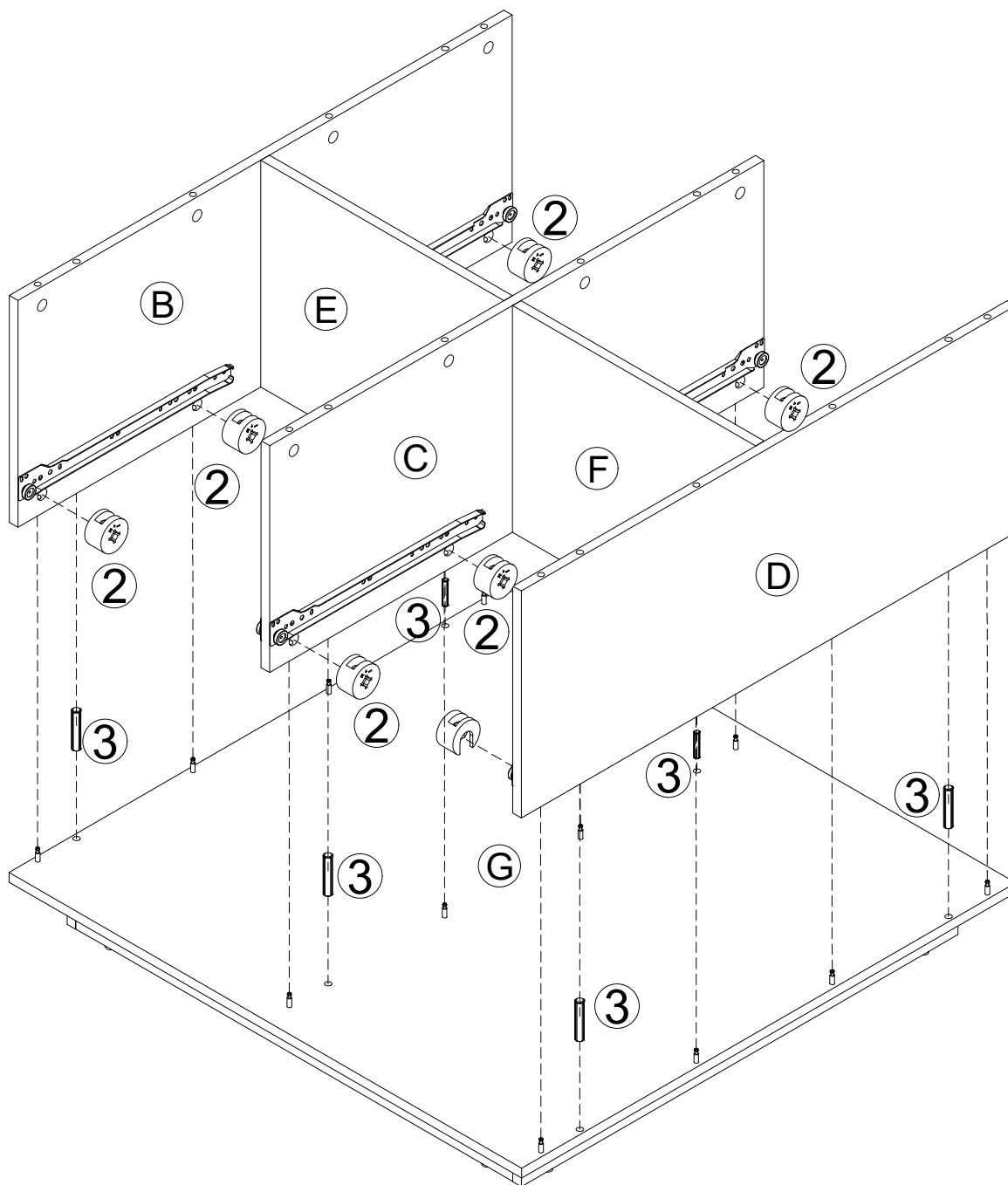

- Make sure arrow feature on Cam (B) points to Cam bolt (A)
- Assurez-vous que la flèche sur la came (B) pointe vers le boulon à came (A)

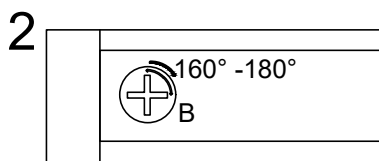

- Rotate cam (B) clockwise 160°-180° to lock parts together.
- Tournez la came (B) dans le sens des aiguilles d'une montre de 160° à 180° afin de verrouiller les pièces ensemble.

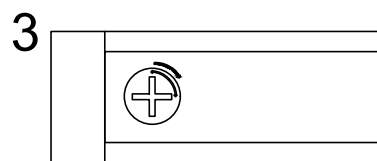

- Parts should be tight against each other and connection should be rigid
- Les pièces doivent être bien serrées l'une contre l'autre et la connexion doit être rigide.

STEP:ÉTAPE 11

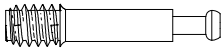
1  12pcs
Ø6x33mm

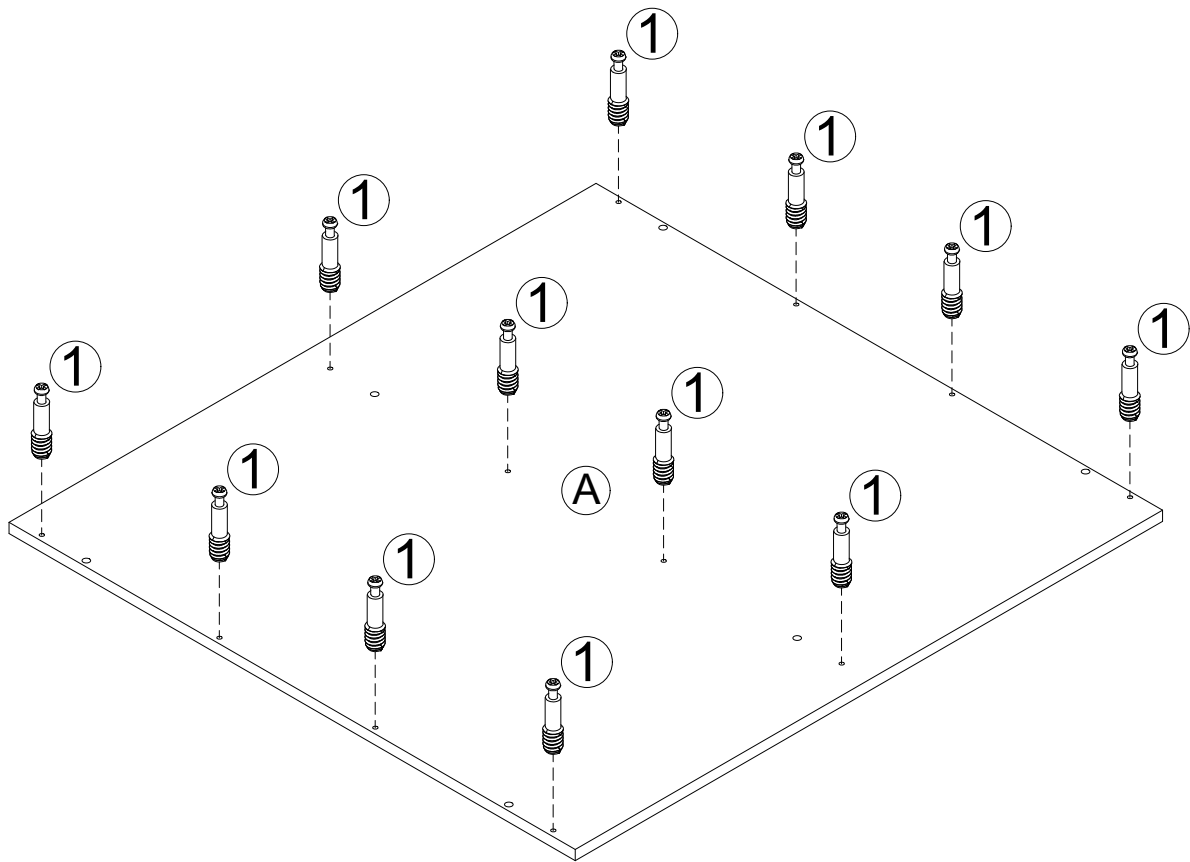

STEP:ÉTAPE 12

②  12pcs
Ø15x9.5mm

③  6pcs
Ø8x30mm

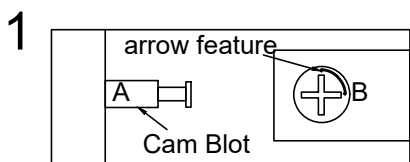
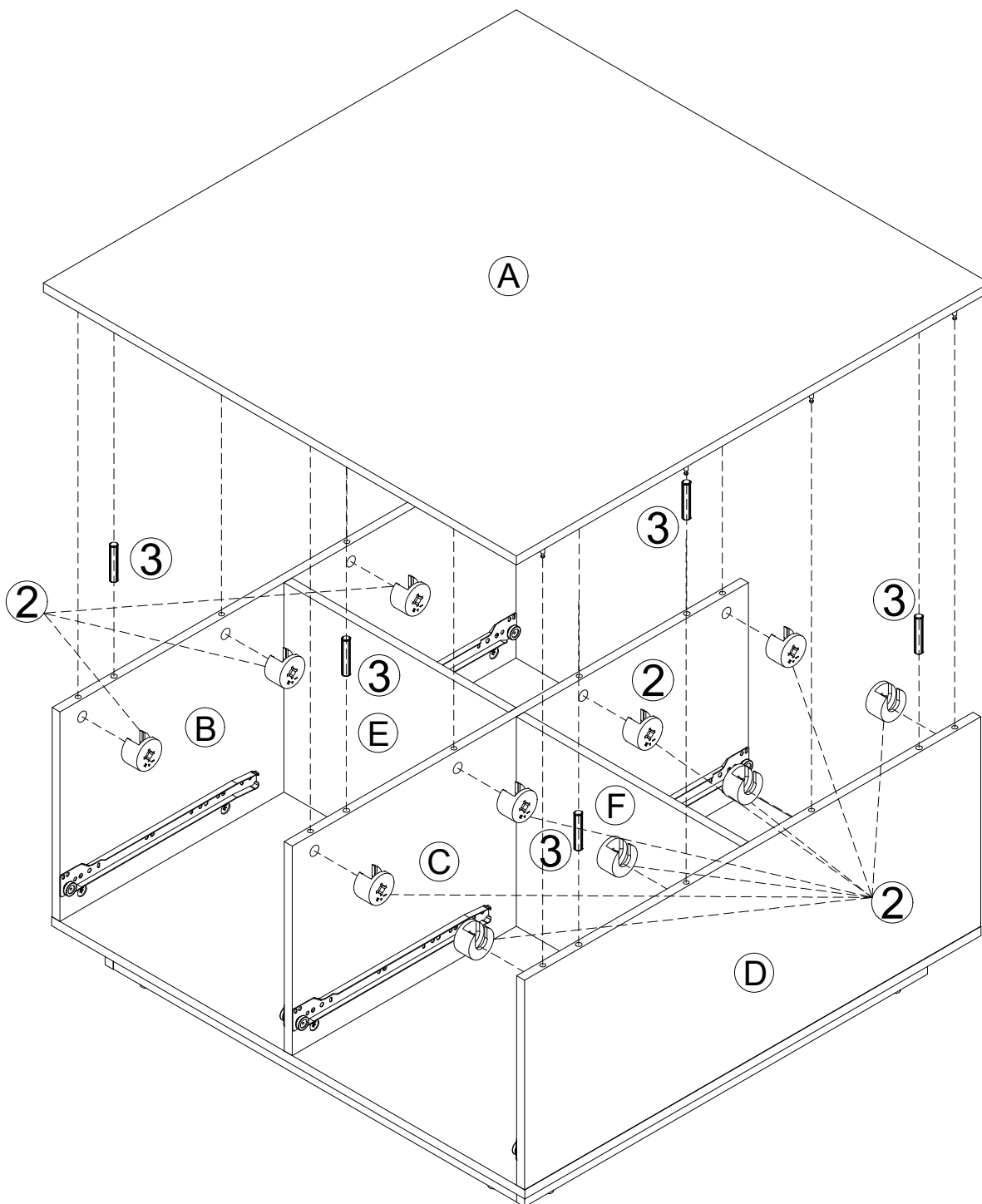

- Make sure arrow feature on Cam (B) points to Cam bolt (A)
- Assurez-vous que la flèche sur la came (B) pointe vers le boulon à came (A)

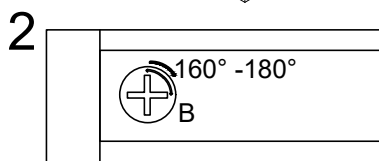

- Rotate cam (B) clockwise 160°-180° to lock parts together.
- Tournez la came (B) dans le sens des aiguilles d'une montre de 160° à 180° afin de verrouiller les pièces ensemble.

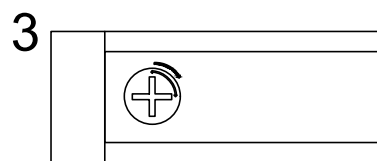

- Parts should be tight against each other and connection should be rigid
- Les pièces doivent être bien serrées l'une contre l'autre et la connexion doit être rigide.

STEP:ÉTAPE 13

4



16pcs

Ø4x30mm

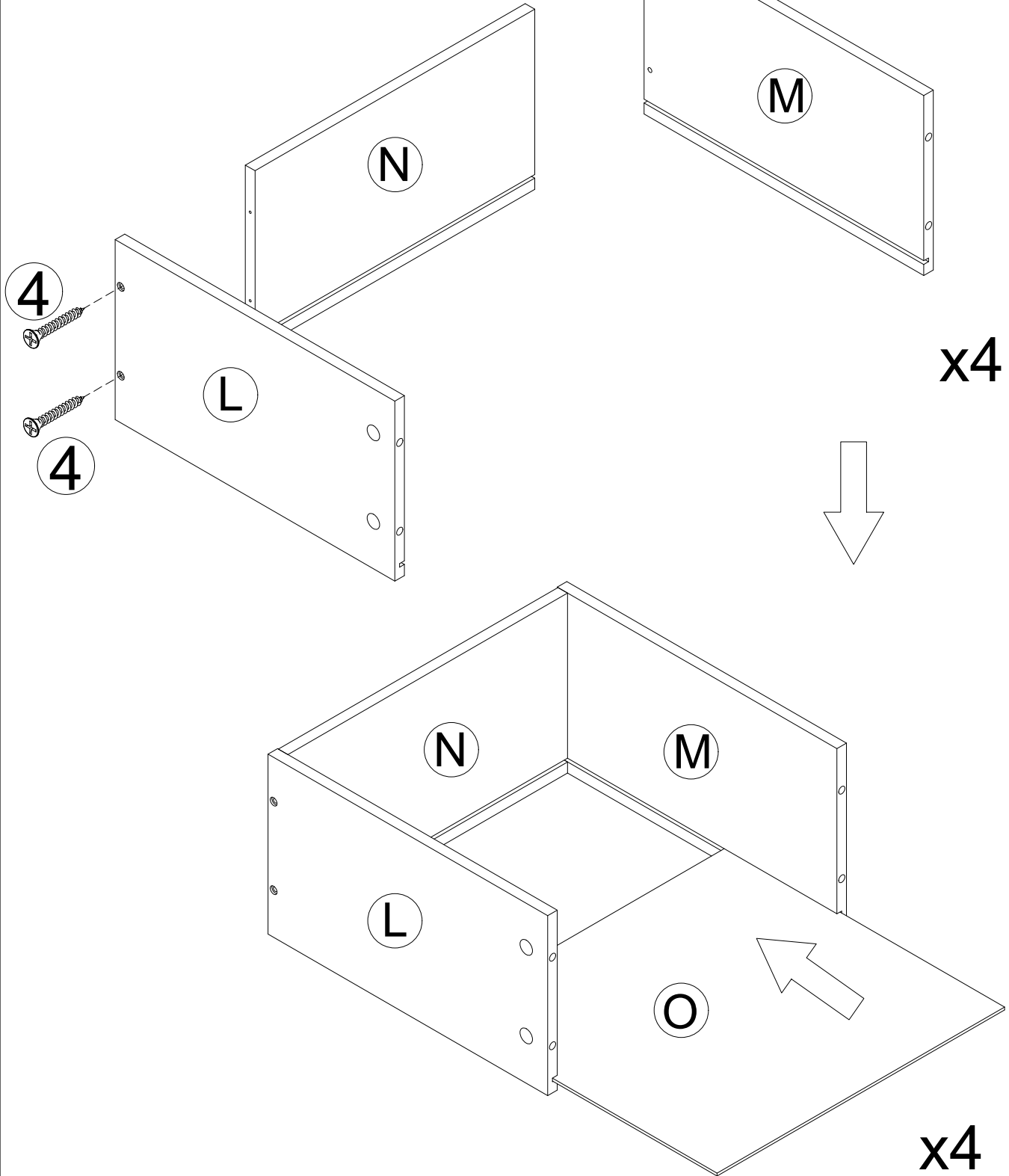

STEP:ÉTAPE 14

①  16pcs
Ø6x33mm

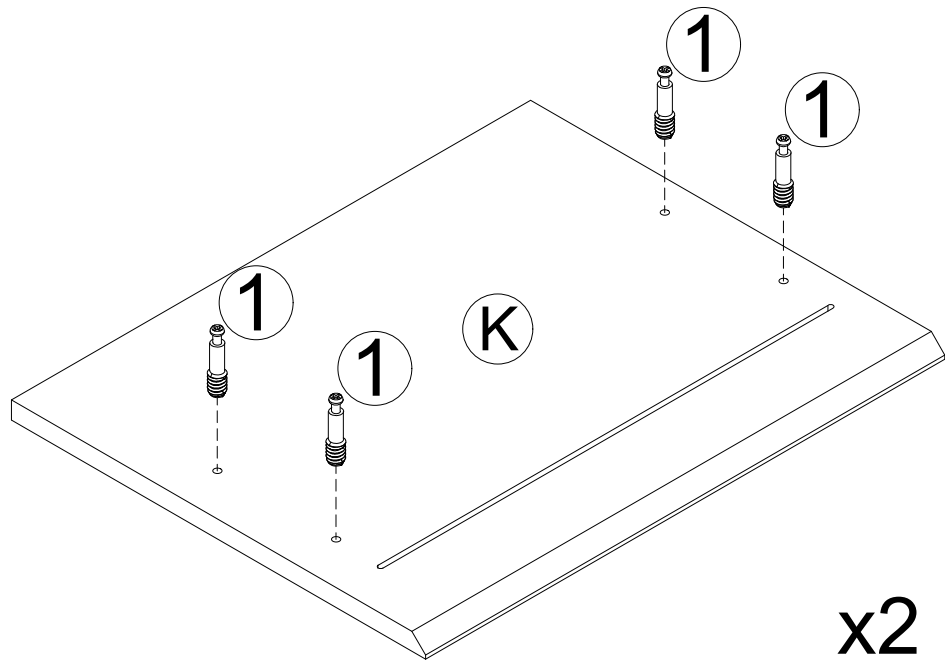
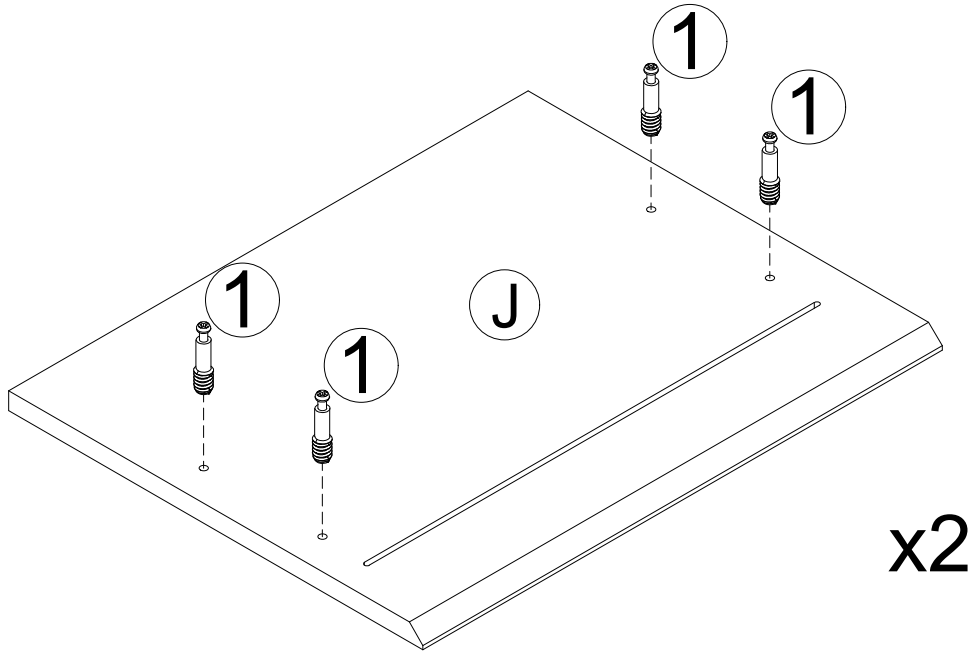

STEP:ÉTAPE 15

②  16pcs
Ø15x9.5mm

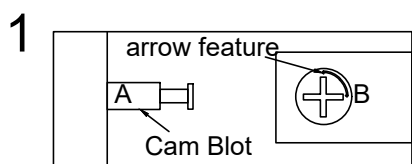
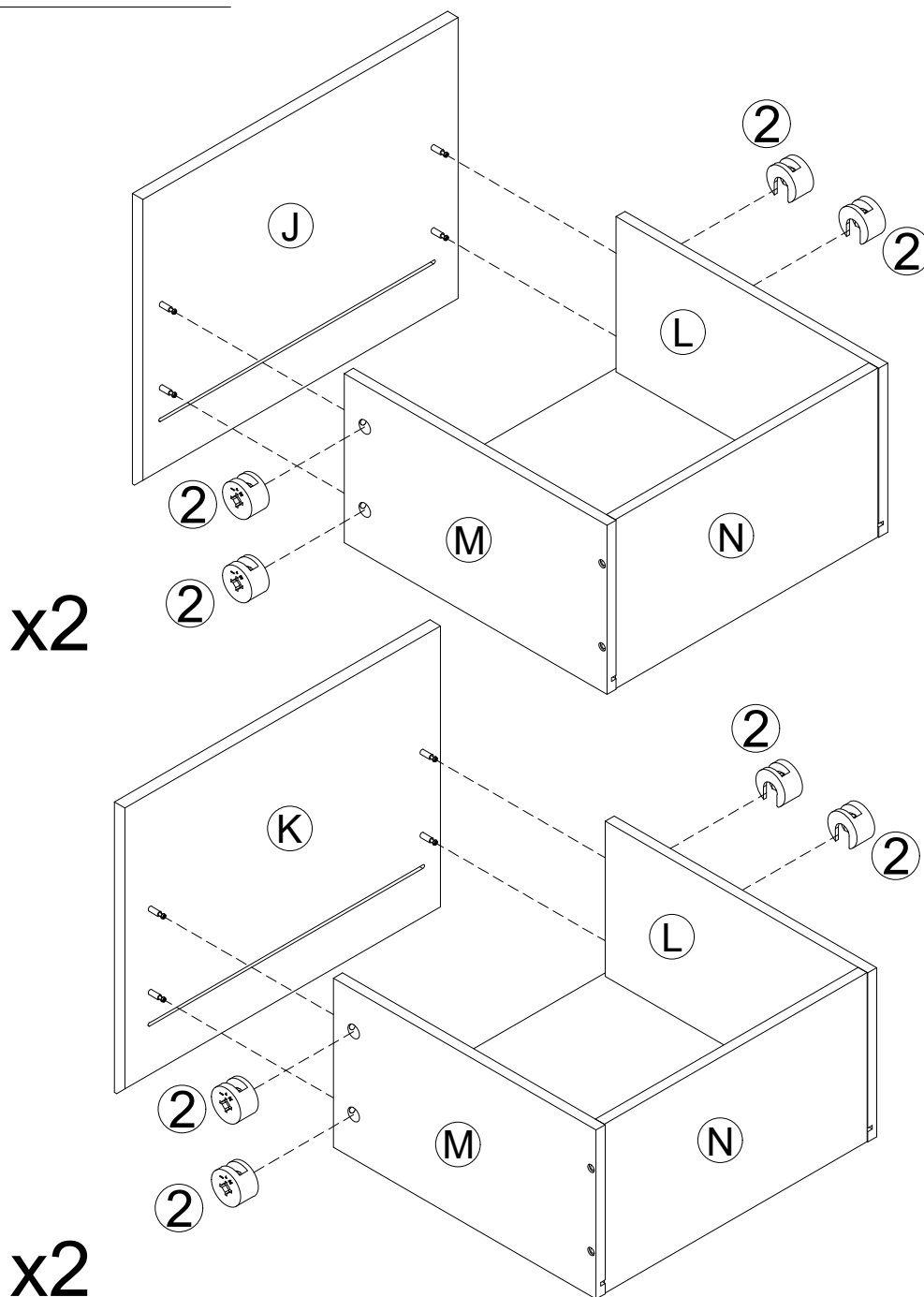

- Make sure arrow feature on Cam (B) points to Cam bolt (A)
- Assurez-vous que la flèche sur la came (B) pointe vers le boulon à came (A)

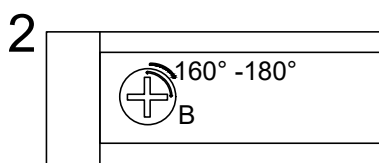

- Rotate cam (B) clockwise 160°-180° to lock parts together.
- Tournez la came (B) dans le sens des aiguilles d'une montre de 160° à 180° afin de verrouiller les pièces ensemble.

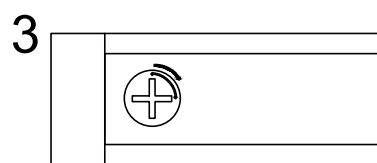

- Parts should be tight against each other and connection should be rigid
- Les pièces doivent être bien serrées l'une contre l'autre et la connexion doit être rigide.

STEP:ÉTAPE 16

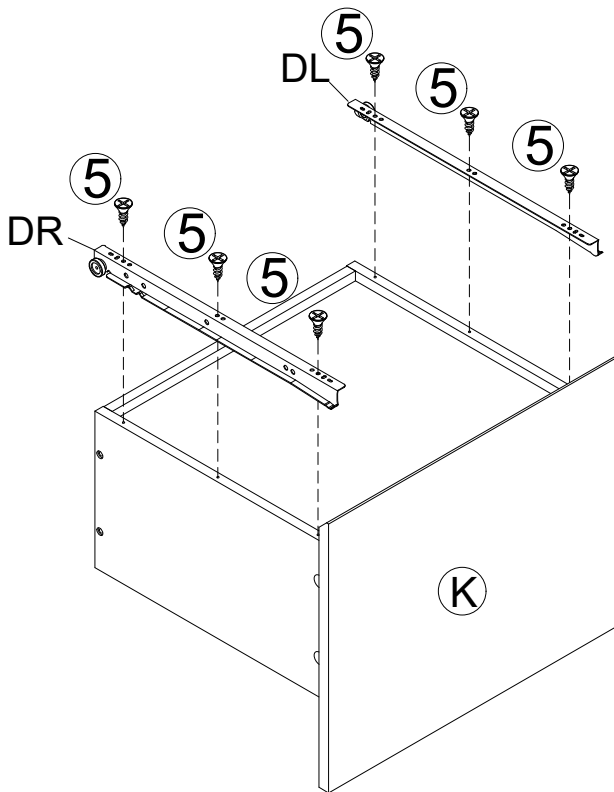
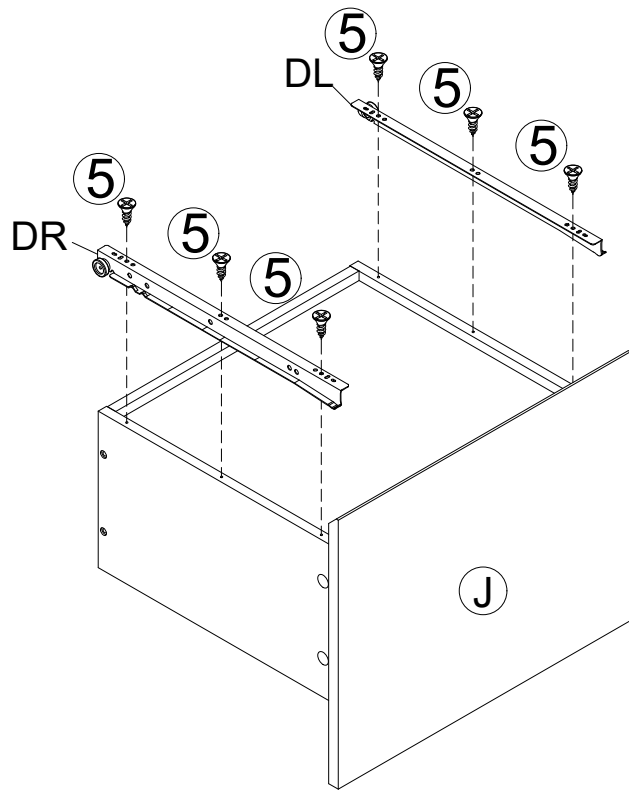
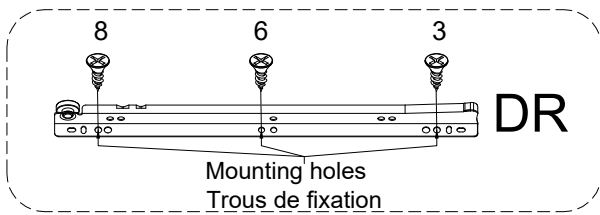
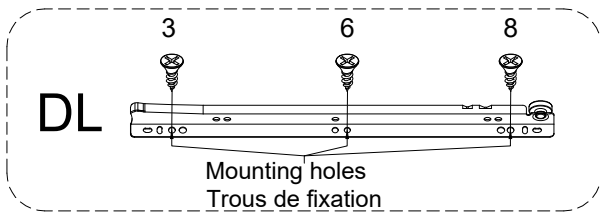
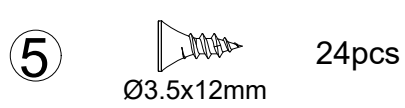
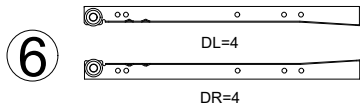

STEP:ÉTAPE 17

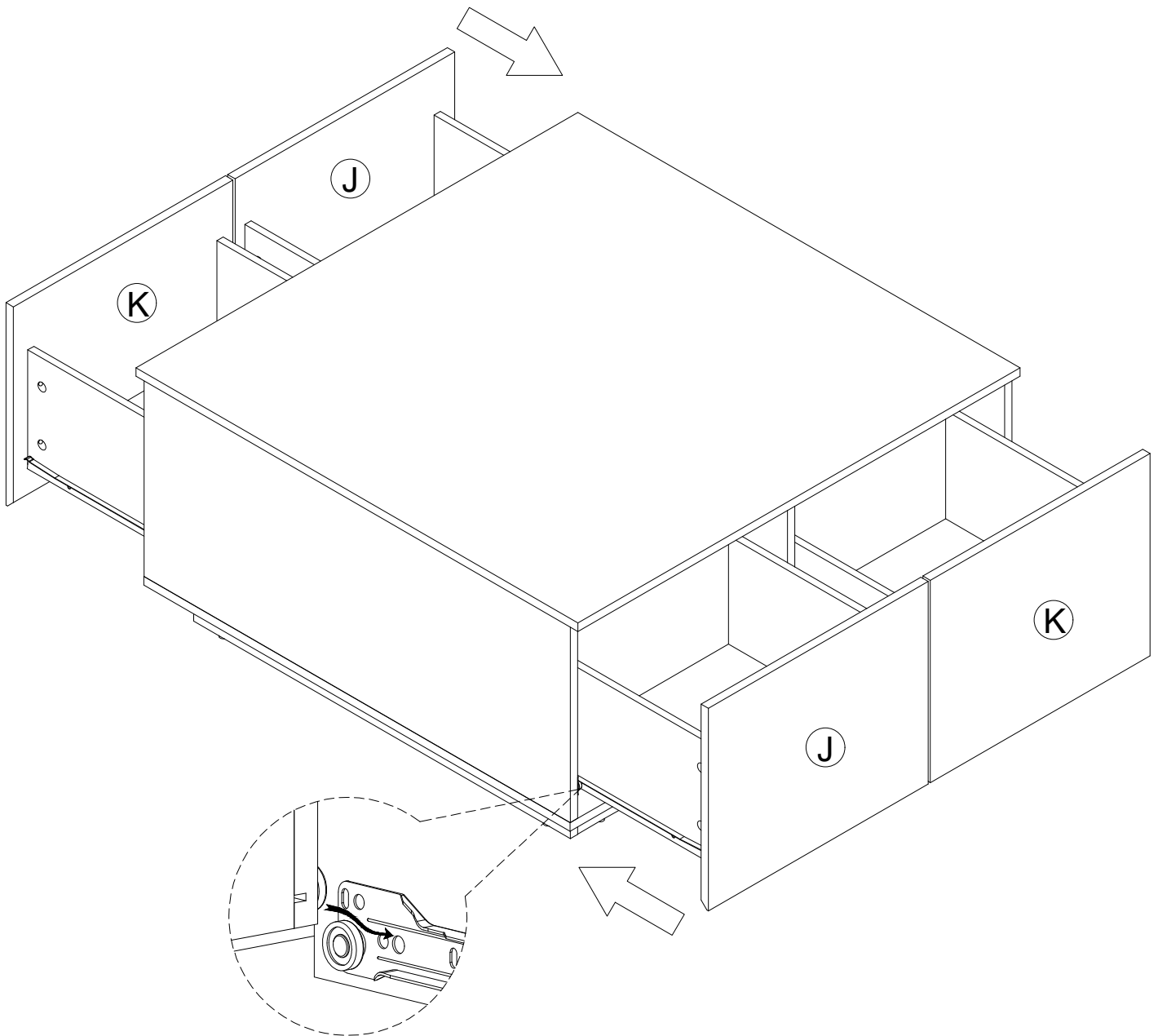

STEP:ÉTAPE 18

