

# ASSEMBLY INSTRUCTIONS

---

## TOOLS REQUIRED

No Tools Required For Assembly



2 - Persons  
Recommended

## ASSEMBLY RATING

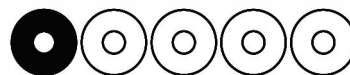

EASY ————— DIFFICULT

The Assembly Rating is a 5-point system showing the level of effort needed to assemble a specific product.



## **CHECK BEFORE STARTING**

### **Are you missing anything?**

Double-check all parts, hardware and accessories listed on Page 6 are accounted for.

### **Check out our Quick Tips!**

We recommend reviewing the pre-assembly handouts. Even experts need a refresher now and then!

### **Should we send any replacements?**

Are there any irregularities or flaws in the parts? We can send replacements!

### **Prep Time!**

Please review the assembly instructions and all diagrams prior to assembling. Arrange parts as recommended on Page 7 and group identical hardware together to make assembling easier.

# PRE ASSEMBLY INTRODUCTION

We understand building ready-to-assemble furniture can be a challenging experience for some. To help avoid confusion, we have provided some helpful tips that may speed up the process.

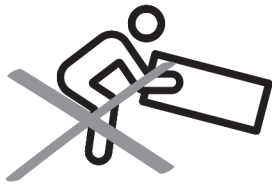

## Teamwork

ALWAYS have at least two people to help with transporting and assembling the product to avoid potential injury and/or damage.

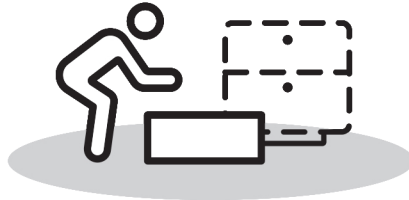
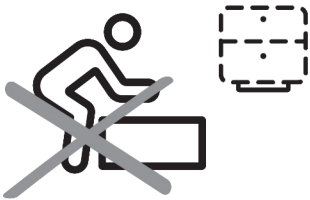

## Suitable Location

Assembling near the area of the intended location is highly recommended.



## Sufficient Space

Make sure you have enough space to move around during the assembly.

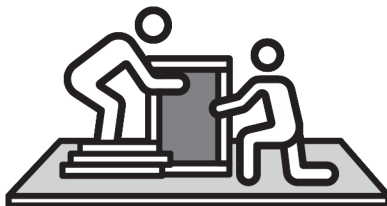

## Avoid Scratches

Use cardboard, blankets or a carpeted area while assembling furniture to prevent scratches.

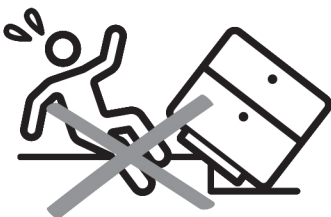

## Flat Surface

Make sure the furniture rests on a flat and level surface with each leg evenly touching the floor.

# ASSEMBLY AND CARE ADVICE



**FAILURE TO FOLLOW THE GUIDELINES BELOW MAY  
RESULT IN INJURY AND/OR PROPERTY DAMAGE.**



Position each part correctly  
and insert screws or bolts into  
their respective holes.



Turn clockwise to tighten and  
only tighten when step is  
completed or when instructed  
to do so.



Use the appropriate hand tools  
or power tools for assembly.  
Select steps, such as tightening  
screws and/or bolts, may require  
hand tools to avoid causing  
damage during assembly.



Save the instructions and store  
any supplied tools for later  
maintenance.

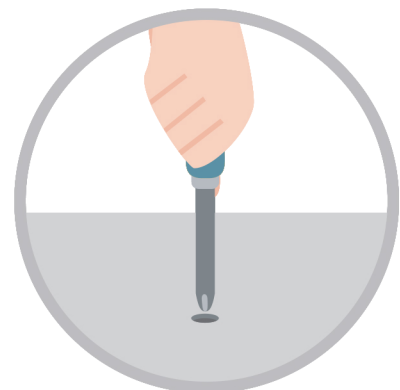

After two weeks, check and  
tighten any loose hardware and  
repeat again every six months  
thereafter.

**IT IS THE USER'S RESPONSIBILITY TO MAINTAIN THE FURNITURE. THE HARDWARE MAY LOOSEN OVER TIME AND MAY CAUSE THE FURNITURE TO BE WOBBLY AND UNABLE TO SUPPORT ITS INTENDED WEIGHT CAPACITY. THIS MAY LEAD TO COLLAPSE AND MAY CAUSE SERIOUS INJURY.**

# ARMOIRE



- Please keep instructions for future reference.
- Check the quantity and irregularity of parts and hardware before you start.



## PARTS

#1 1pc



Armoire

#2 4pcs



Bun Foot

## HARDWARE

#A 4pcs



Threaded Stud  $\text{Ø}5/16 \times 2\text{-}3/4\text{'}$

# ASSEMBLY INSTRUCTIONS

1

Part #1 x1pc  
Part #2 x4pcs  
Hardware #A x4pcs

Attach threaded studs (#A) to the armoire (#1), then secure bun feet (#2) to the treaded studs (#A) of the armoire (#1).

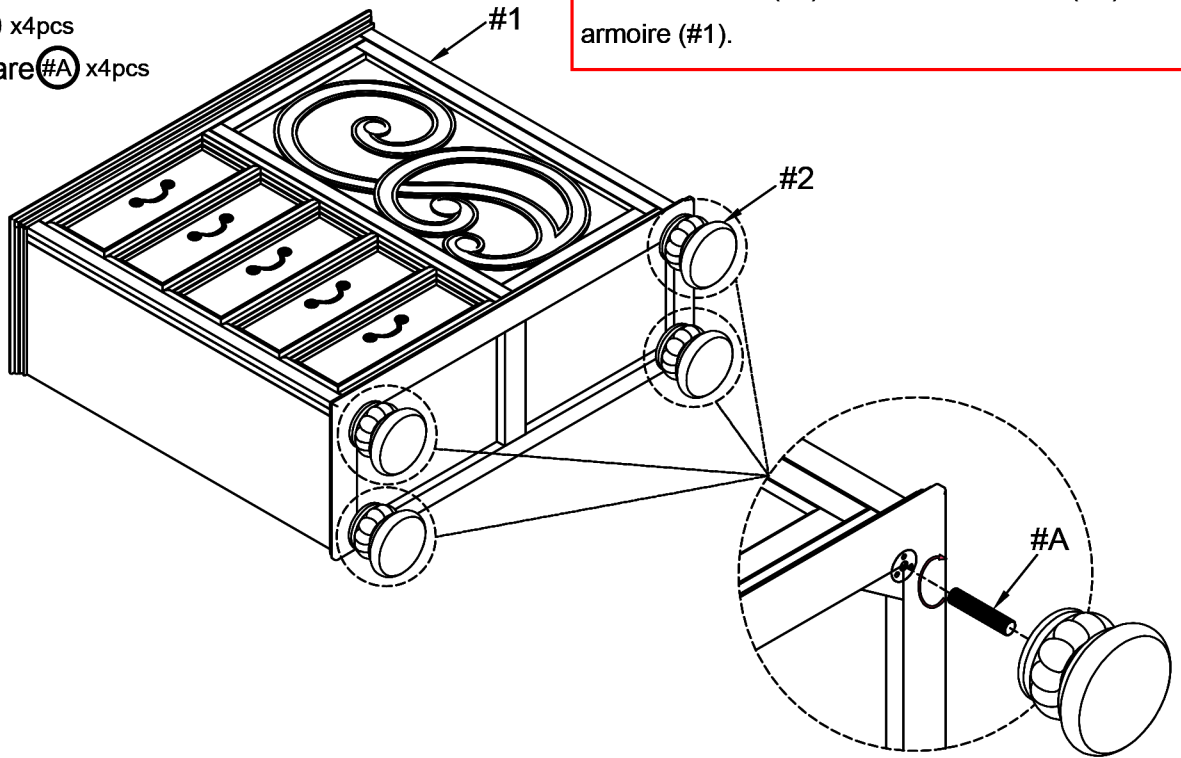

2



## ASSEMBLY COMPLETED



Please ensure the furniture rests on an even and flat surface. If the product wobbles or feels loose, double-check all bolts and/or screws are properly tightened and secured.



### Keep this handy!

Please retain this instruction manual and any order-related information for future reference.