

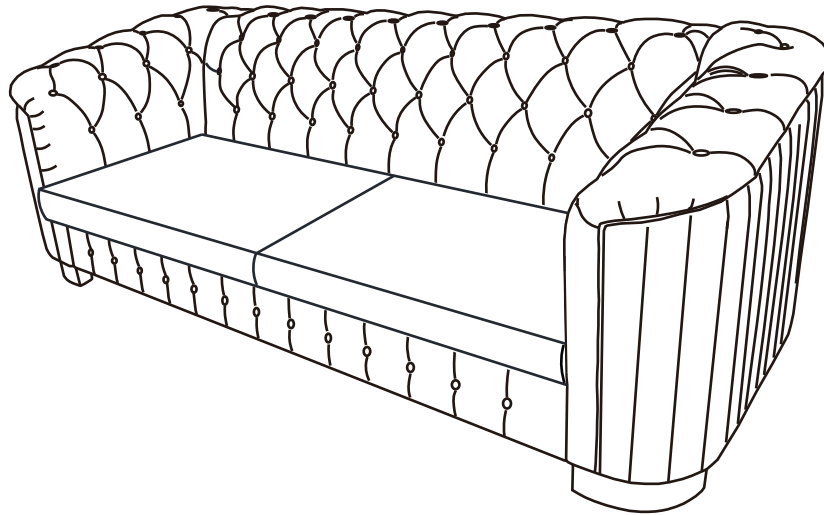



ASSEMBLY INSTRUCTIONS

3 SEATER SOFA

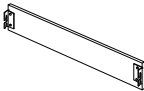

3 SEATER SOFA is packed in 3 cases

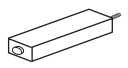
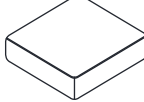
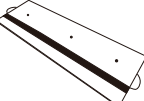
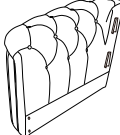
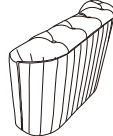
Carton	Disignation	Part	Hardware
1/3	Backrest	#1 	<div style="display: flex; flex-wrap: wrap; justify-content: space-around;"> <div style="border: 1px solid black; border-radius: 50%; padding: 2px; margin: 2px;">#A</div> <div style="border: 1px solid black; border-radius: 50%; padding: 2px; margin: 2px;">#B</div> <div style="border: 1px solid black; border-radius: 50%; padding: 2px; margin: 2px;">#C</div> <div style="border: 1px solid black; border-radius: 50%; padding: 2px; margin: 2px;">#D</div> <div style="border: 1px solid black; border-radius: 50%; padding: 2px; margin: 2px;">#E</div> <div style="border: 1px solid black; border-radius: 50%; padding: 2px; margin: 2px;">#F</div> </div>
	Former board	#2 	
	Leg	#3 	
	Support leg	#4 	
2/3	Cushion	#5 	
	Riser plate	#6 	
3/3	Left arm	#7 	
	Right arm	#8 	

ASSEMBLY INSTRUCTIONS

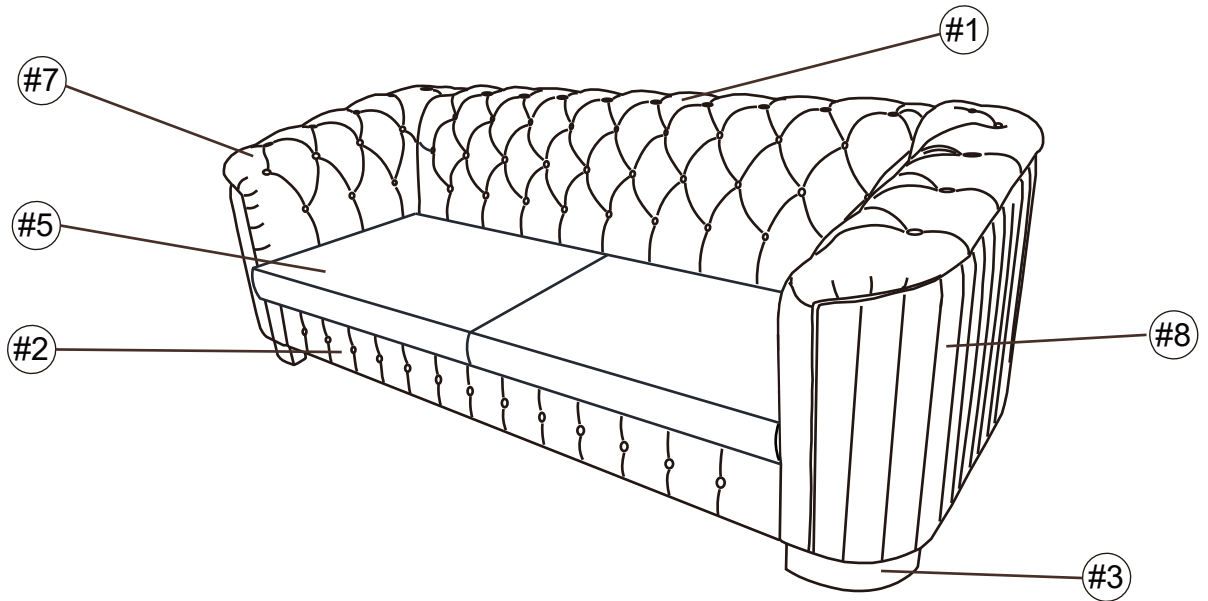

PARTS

#1 1 pc

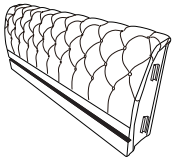

Backrest

#2 1 pc

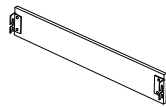

Former board

#3 4 pcs

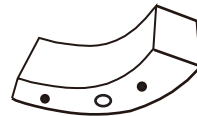

Leg

#4 3 pcs

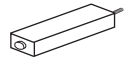

Support leg

#5 2 pcs

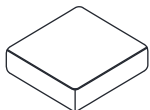

Cushion

#6 1 pc

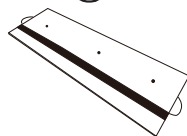

Riser plate

#7 1 pc

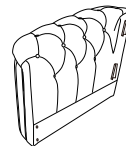

Left arm

#8 1 pc

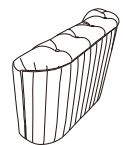

Right arm

HARDWARE

#A 4 pcs



BOLT 1-1/2 "L

#B 1 pc



ALLEN KEY 100mm L

#C 8 pcs



FLAT WASHER 16mm

#D 8 pcs



SPRING WASHER

#E 8 pcs



Screw 60mm L

#F 4 pcs



BOLT 2-1/2" L

ASSEMBLY INSTRUCTIONS

STEP1:

Pull the HOOK&LOOP in the bottom of backrest (#1) and open it, take out #4 support leg and paper box (legs(#3)HARDWARE)

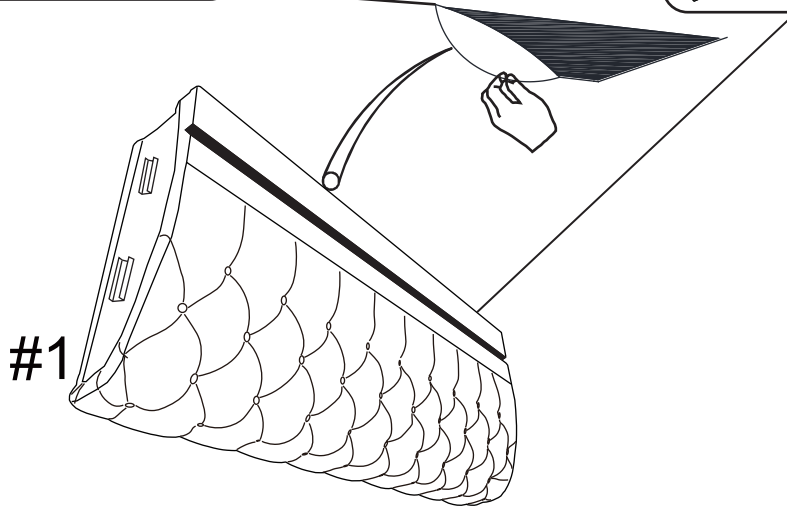
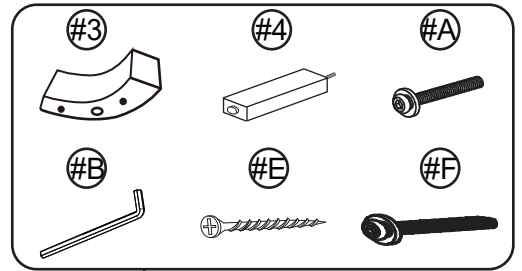

STEP2:

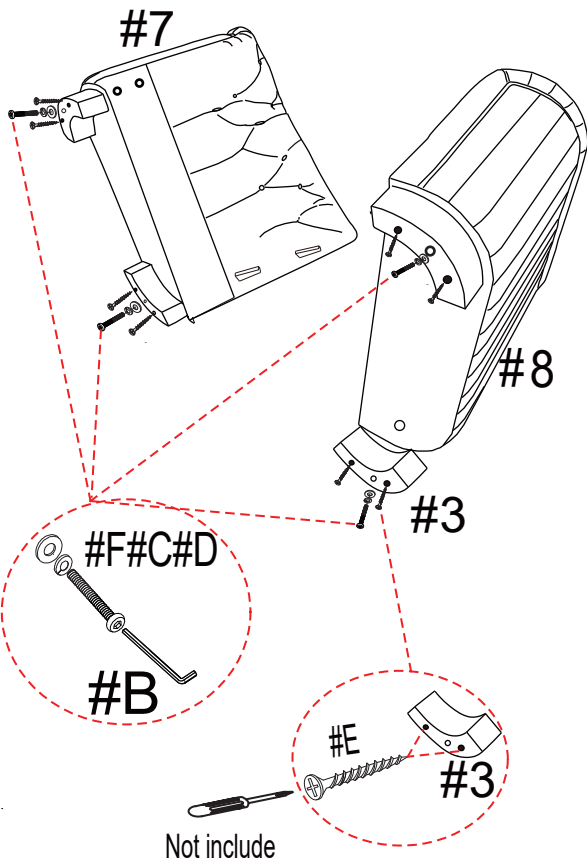

STEP3:

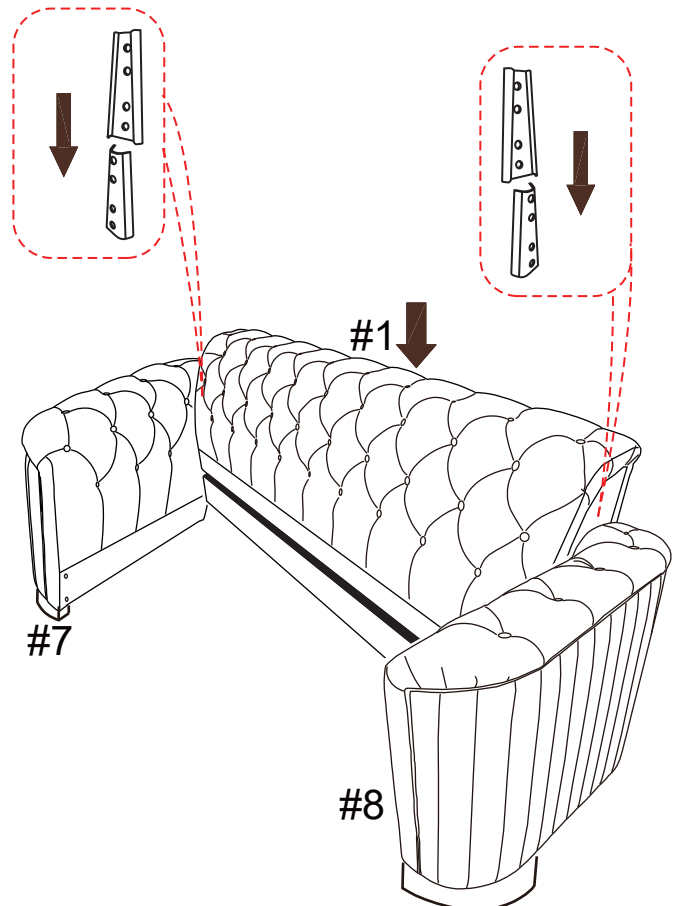

ASSEMBLY INSTRUCTIONS

STEP4:

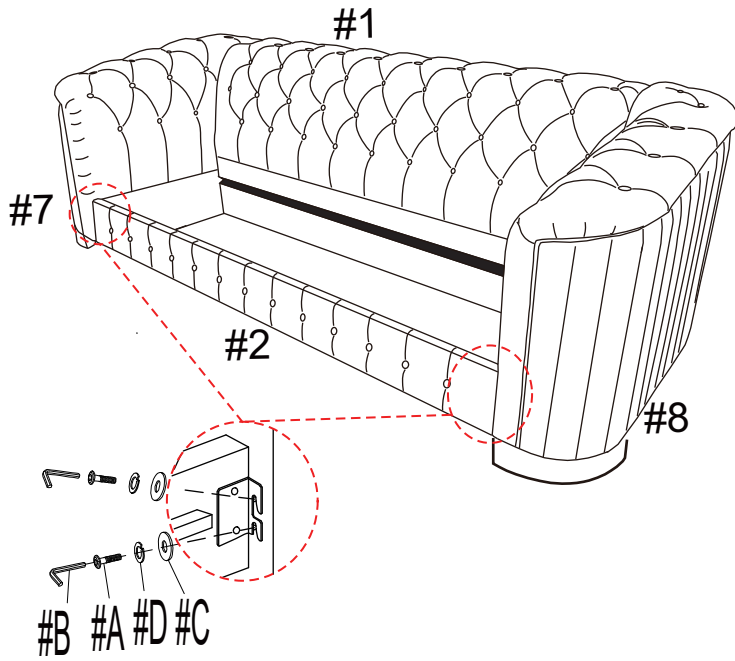

STEP5:

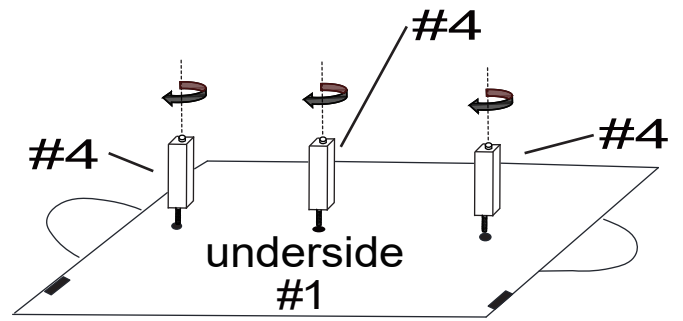

STEP6:

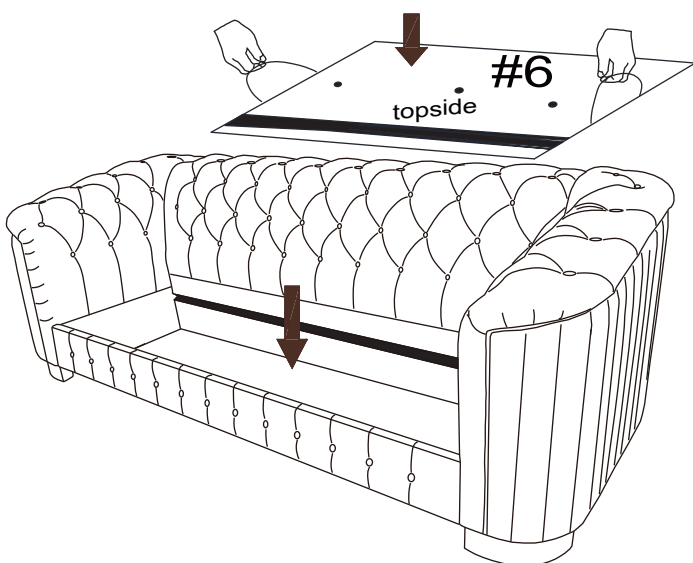

STEP7:

