

WARNING

- * Switch off the main electrical supply from the main fuse box / circuit breaker before installation.
- * Inspect item carefully before attempting to install.
- * If there is any damages or obvious defects, do not install.
- * Item may not be returned once it has been installed.















CARE AND MAINTENANCE

- * To clean the outside of the fixture, use a dry or slightly dampened clean cloth (use clean water, never a solvent) to wipe the surface of the fixture.
- * To clean the inside of the fixture, first disconnect power to the fixture by turning off the circuit breaker or by removing the fuse at the fuse box. Next, use a dry or slightly dampened clean cloth (use clean water, never a solvent) to wipe the interior surface of the fixture.
- * Do not use any cleaners with chemical, solvents or harsh abrasives. Use only a dry soft cloth to dust or wipe carefully.

NOTICE& IMPORTANT SAFETY INSTRUCTIONS

- ** WE RECOMMEND INSTALLATION OF THIS LIGHTING FIXTURE BE DONE BY A LICENSED ELECTRICIAN **
- * Please make sure that you have all parts indicated before you begin assembly of this item
- * This item should be assembled on a soft surface to prevent scratching the finish during assembly
- * To reduce the risk of fire, electrical shock or injury to persons or property, please follow the guideline below for safe use and installation

Part List and Hardware List

PIECE	DESCRIPTION	PICTURE	QUANTITY	PIECE	DESCRIPTION	PICTURE	QUANTITY
A	Mounting Plate		1X	I	Round loop		1X
B	Mounting Screw		2X	J	Arm body		1X
C	Wire Nut		3X	K	Bulb		5X
D	canopy		1X	L	Metal cup		5X
E	Hanging Loop		1X	M	Glass		5X
F	Canopy Nut		1X	N	Iron cylinder		5X
G	Closable Link		2X	O	Flat pipe ring		1X
H	Chain		1X				

Product Dimensions: 25"L X 25"W X 29-88"H

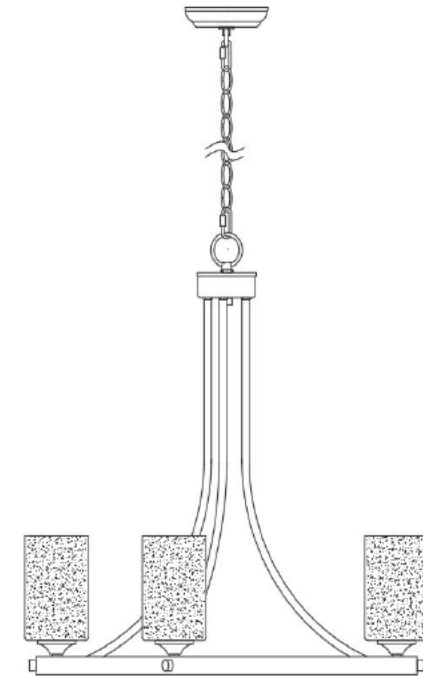

PREPARATION

- * Before beginning assembly of product, make sure all parts are present. Compare parts with package contents list and hardware contents list.
- * If any part is missing or damaged, do not attempt to assemble the product.
- * Estimated Assembly Time: 20 minutes.
- * Tools Required for Assembly (not included): Screwdriver, Junction box

NOTE: PLEASE USE TYPE "A" BULB MAX 40-WATT OR LED BULB MAX 9-WATT, THERE ARE 5X LED 4-WATT BULB IN THE BOX

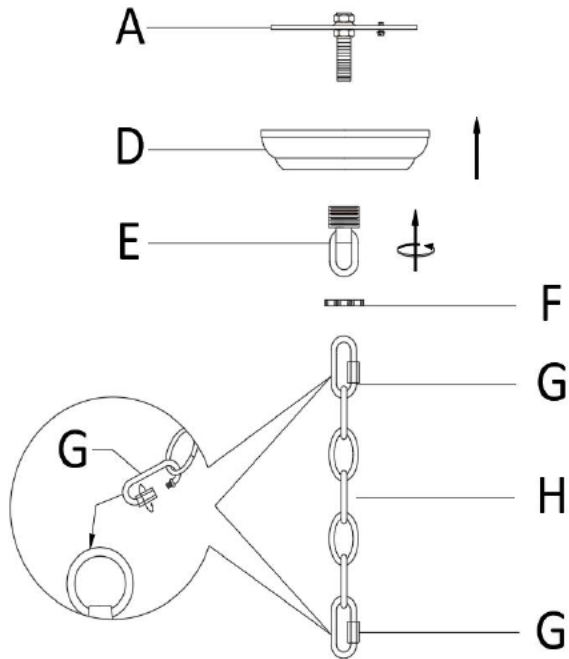

Step 1: Unpack all parts from cartons carefully. Place the Canopy (D) onto the Hanging Loop (E). Place the tube of the Mounting Plate (A) into the threaded portion of the Hanging Loop (E) and assemble by turning the Canopy Nut (F) clockwise till tight. Attach the Closable Link (G) onto the Hanging Loop (E)

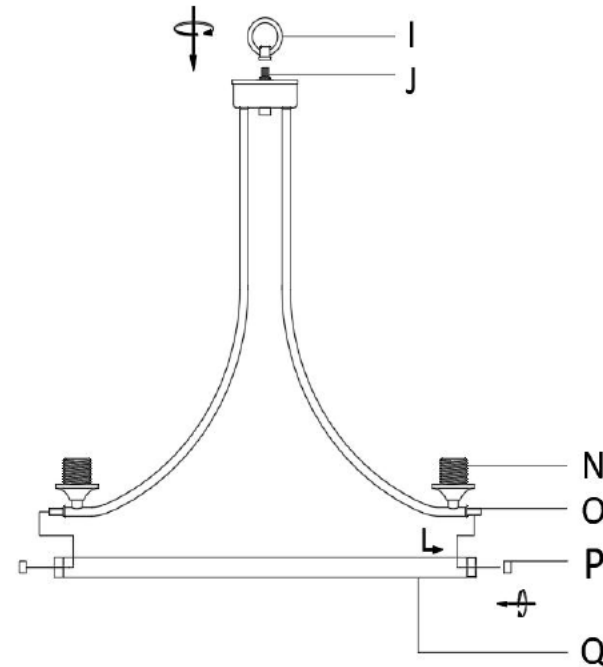

Step 2: Spread Arm body (O) to an equal distance apart. Then put Arm body (O) through holes in Flat pipe ring (Q), and secure it by Iron cylinder (P). Fasten Round loop (C) to Arm Assembly (J) of the nipple.

PREPARATION

- * Before beginning assembly of product, make sure all parts are present. Compare parts with package contents list and hardware contents list.
- * If any part is missing or damaged, do not attempt to assemble the product.
- * Estimated Assembly Time: 20 minutes.
- * Tools Required for Assembly (not included): Screwdriver, Junction box

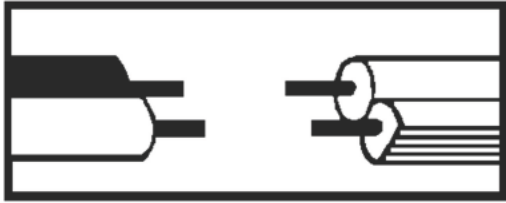

Step 3: Wire connection

Connect fixture neutral wire (ribbed) to the outlet box neutral wire (usually white) using a wire nut. Connect fixture hot wire (smooth with markings) to the outlet box hot wire (usually black) using a wire nut.

CAUTION: Do not reverse the hot and neutral connections

Grounding Instructions:

Wrap ground wire from outlet box around green ground screw(B) on mounting bracket, no less than 2" from wire end. Tighten ground screw. If fixture is supplied with a ground wire, connect to outlet ground wire with a wire connector.

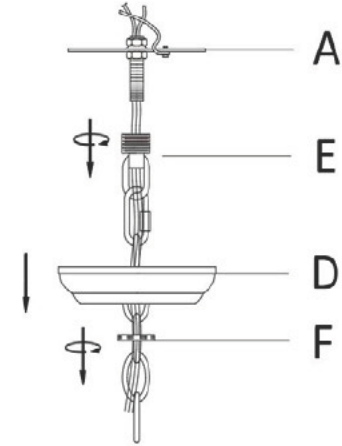

Step 4: Install the Mounting Plate(A) to the junction box with Mounting Screw (B). Separate the Mounting Plate(A) from the Canopy(D) by turning the Canopy Nut (F) anti-clockwise.

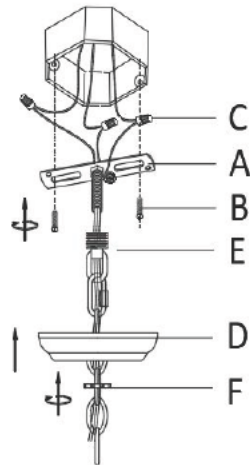

Step 5: Attach the Canopy (D) to the junction box and fix it by turning the Canopy Nut (F) clockwise.

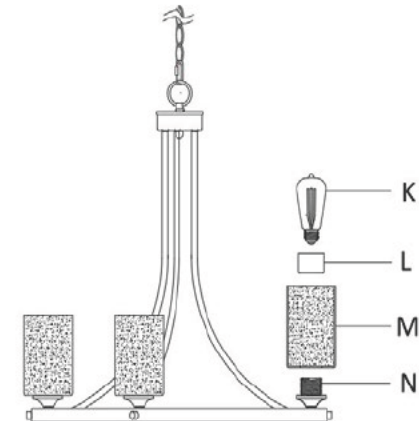

Step 6: Put Glass (M) on Lamp holder (N), then fasten it with Metal cup (L), insert the bulbs (K) into the Sockets