

ASSEMBLY INSTRUCTIONS

1. Before installation, please read the Assembly Instruction carefully.
2. Please check whether the Parts and Hardware are consistent with the list.
3. It is normal for the sealed environment to smell, not a product quality problem.

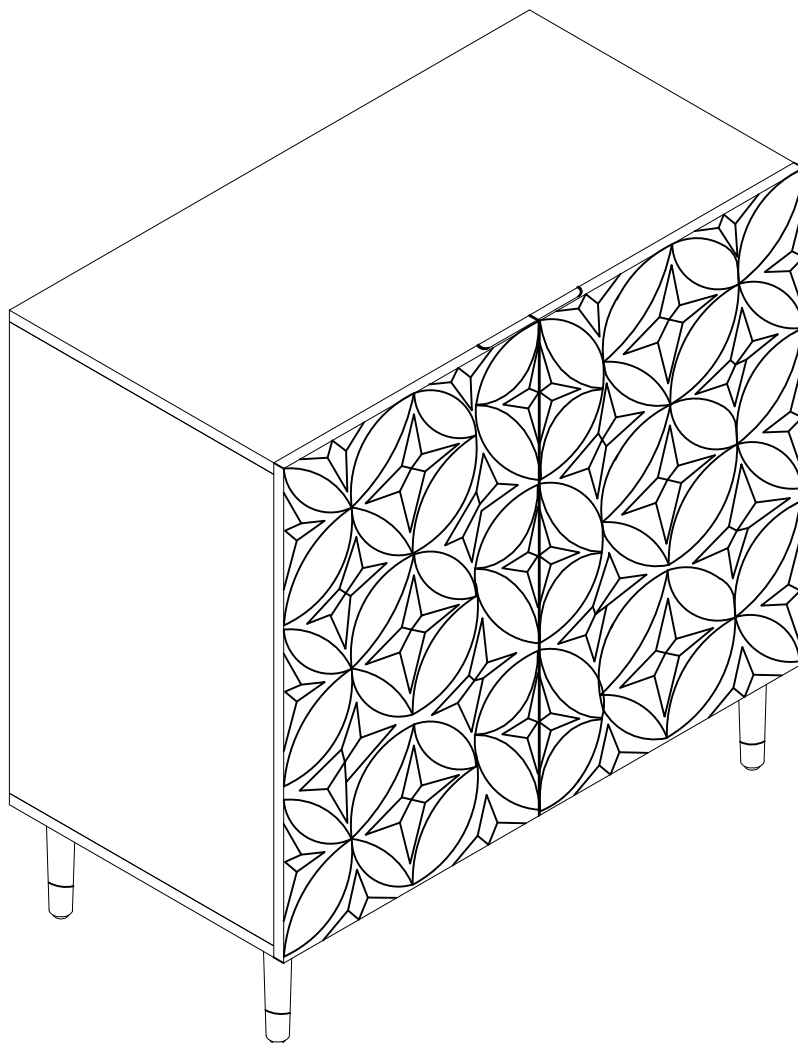

Phone number: 303-747-4421



service@clihome.net

Web: www.clihome.net

MADE IN CHINA

ASSEMBLY INSTRUCTIONS

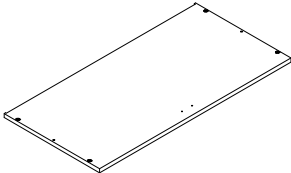
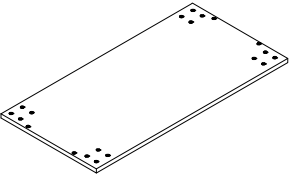
Part List:

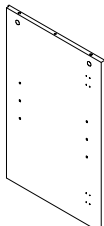
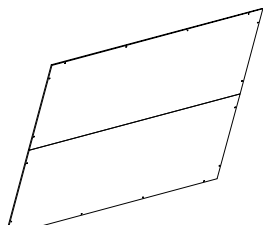



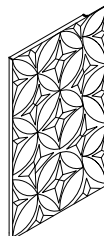
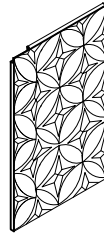
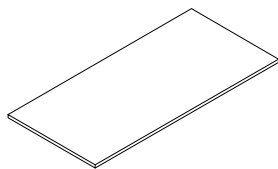
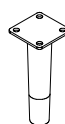

ITEM	DESCRIPTION	PART	QTY
1	Top panel		1
2	Bottom panel		1
3	Left side panel		1
4	Right side panel		1
5	Back panel		1

Part List:

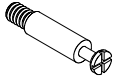



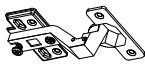

ITEM	DESCRIPTION	PART	QTY
6	Left door		1
7	Right door		1
8	Adjustable shelf		1
9	Leg		4

ASSEMBLY INSTRUCTION

Hardware List:

ITEM	DESCRIPTION	PART	QTY
A	Camlock bolt		4
B	Camlock		4
C	Wooden dowel	 Φ6*30mm	4
D	Bolt	 Φ1/4"*1/2"	16
E	Allen wrench		1
F	Bolt	 Φ1/4"*3/4"	4
G	Door fitting		4

Hardware List:

ITEM	DESCRIPTION	PART	QTY
H	Round head screw	 Φ4*14mm	24
I	Back screw	 Φ3*12mm	16
J	Shelf support		4
K	Safety wall strap		1
L	Plastic anchor		1
M	Mounting screw	 Φ4*38mm	1
N	Washer		1

ASSEMBLY INSTRUCTION

- * Required screwdriver & mallet, not included.
- * Before discarding packing materials, please check to make sure that all parts and hardware is present.
- * Two people needed for assembly.
- * Please follow the instructions closely; do not over tighten screws or bolts unless instructed.
- * After a few days from initial assembly, the product may have acclimated to the new environment. Please retighten the hardware.

Guideline For Assembling of Cam Lock(A & B)

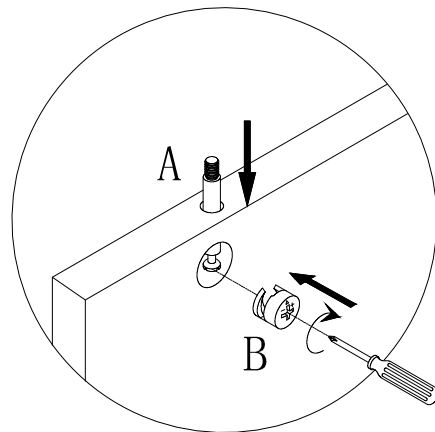
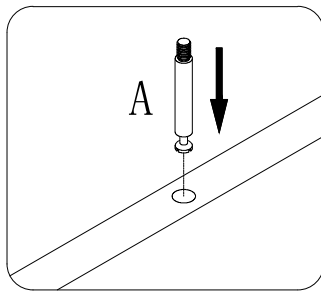



Screw camlock bolt (A) to wood part.

Do not assemble camlock (B) unless instructed.

To assemble camlock (B), ensure long side of the + is facing the bolt (A) before inserting into hole.



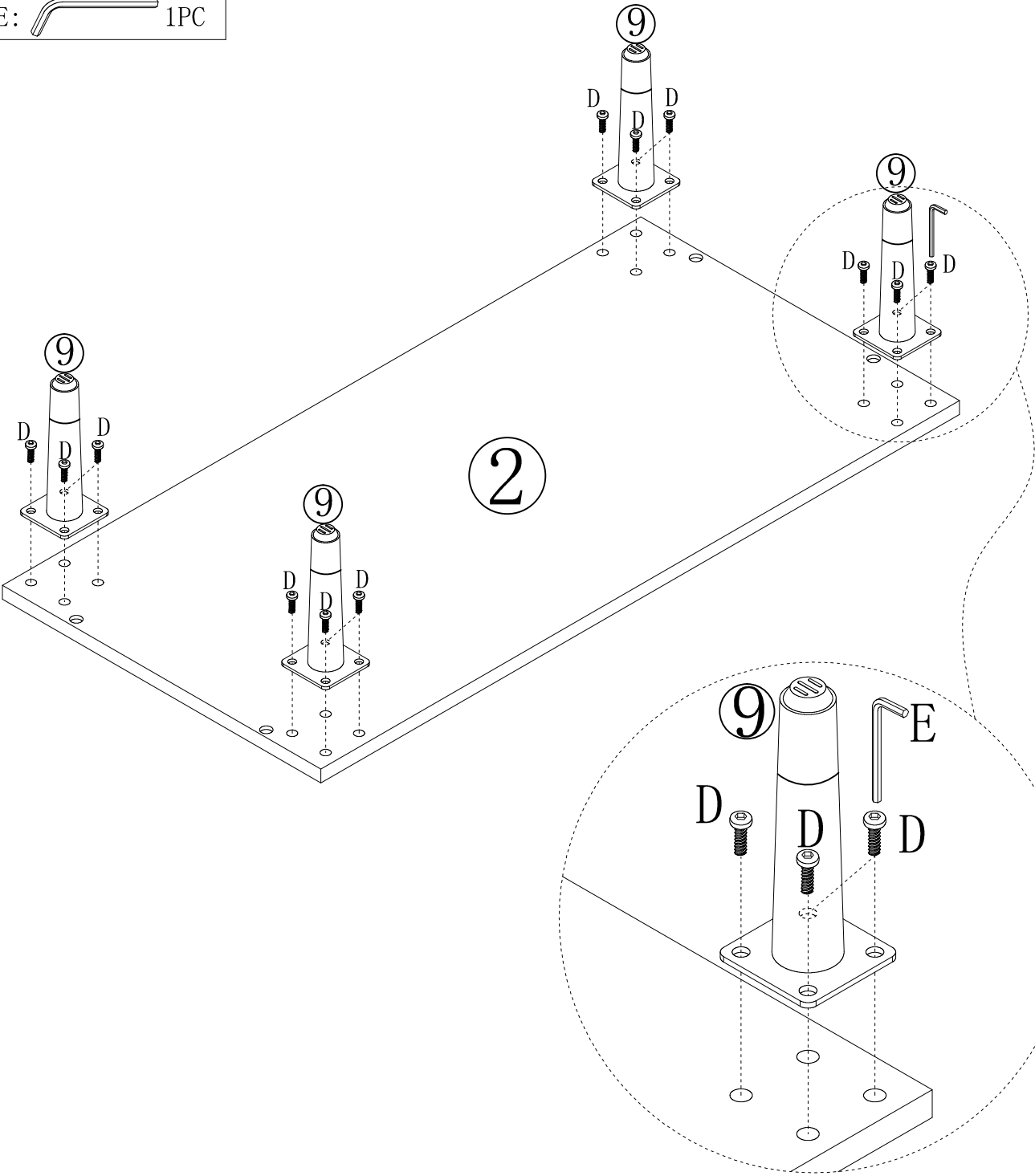

STEP 1

- D:  16PCS
- E:  1PC

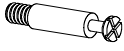

ASSEMBLY INSTRUCTION

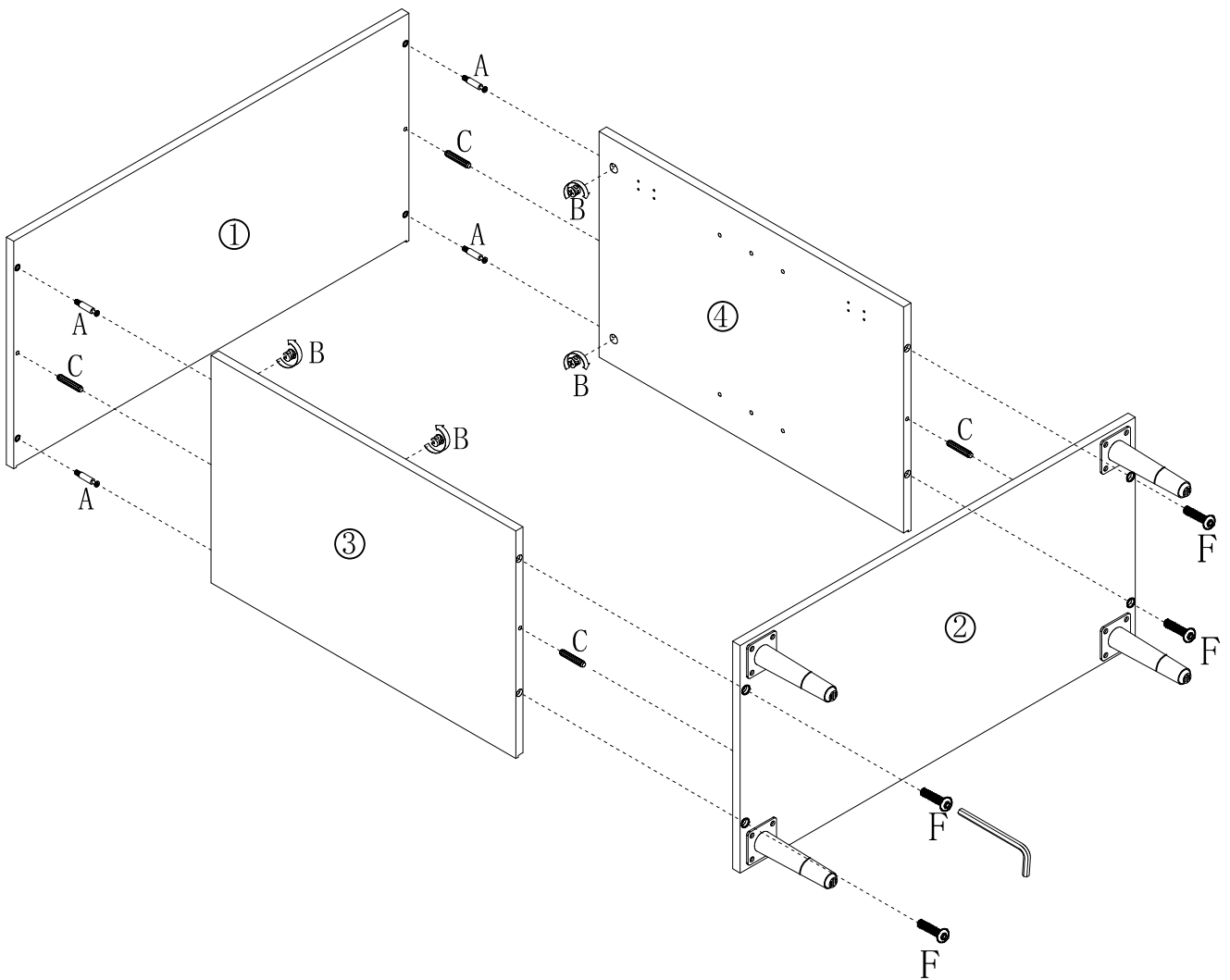

STEP 2

A:		4PCS
B:		4PCS
C:		4PCS
F:		4PCS





ASSEMBLY INSTRUCTION

STEP 3

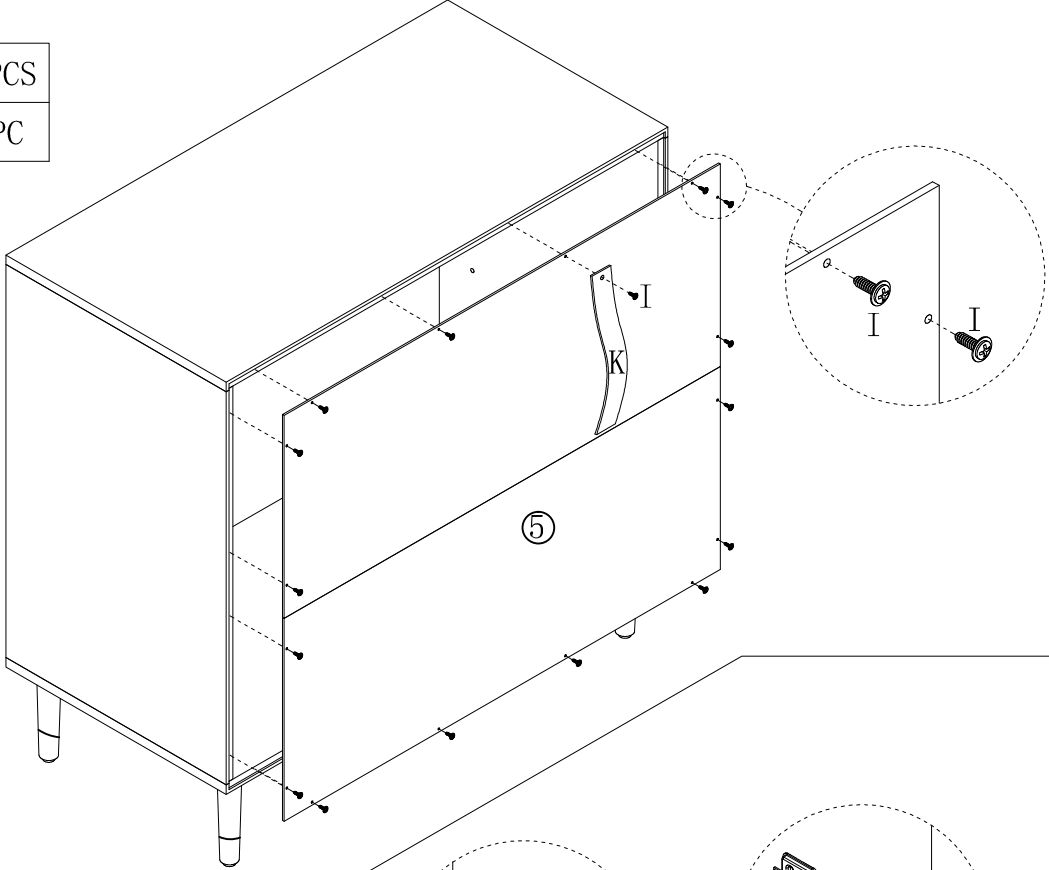
I:		16PCS
K:		1PC



STEP 4

G:		4PCS
H:		8PCS

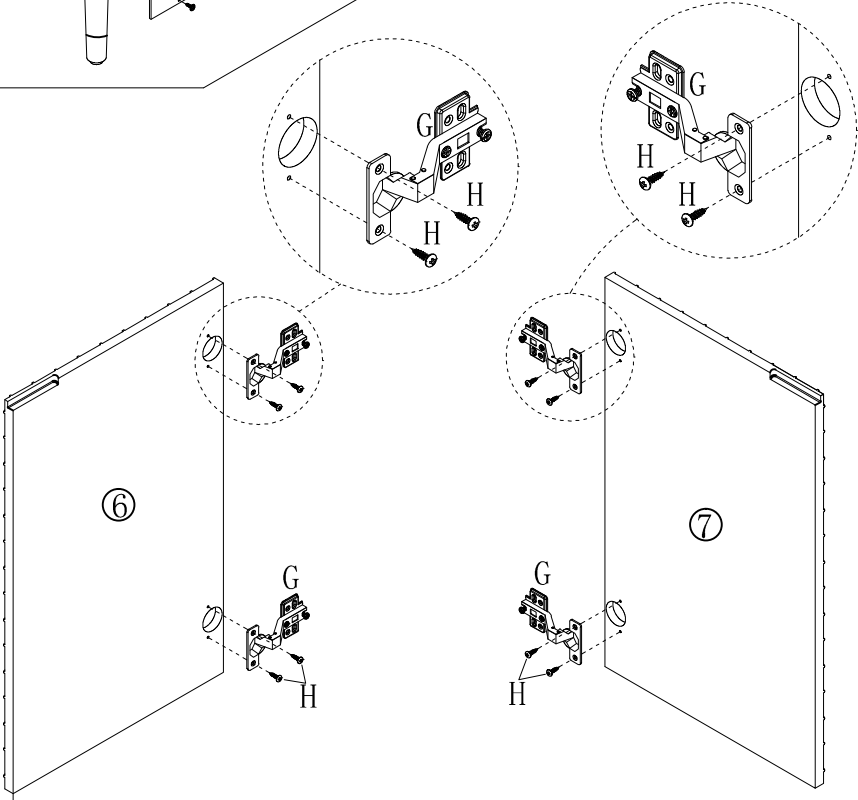

ASSEMBLY INSTRUCTION

STEP 5

H:  16PCS

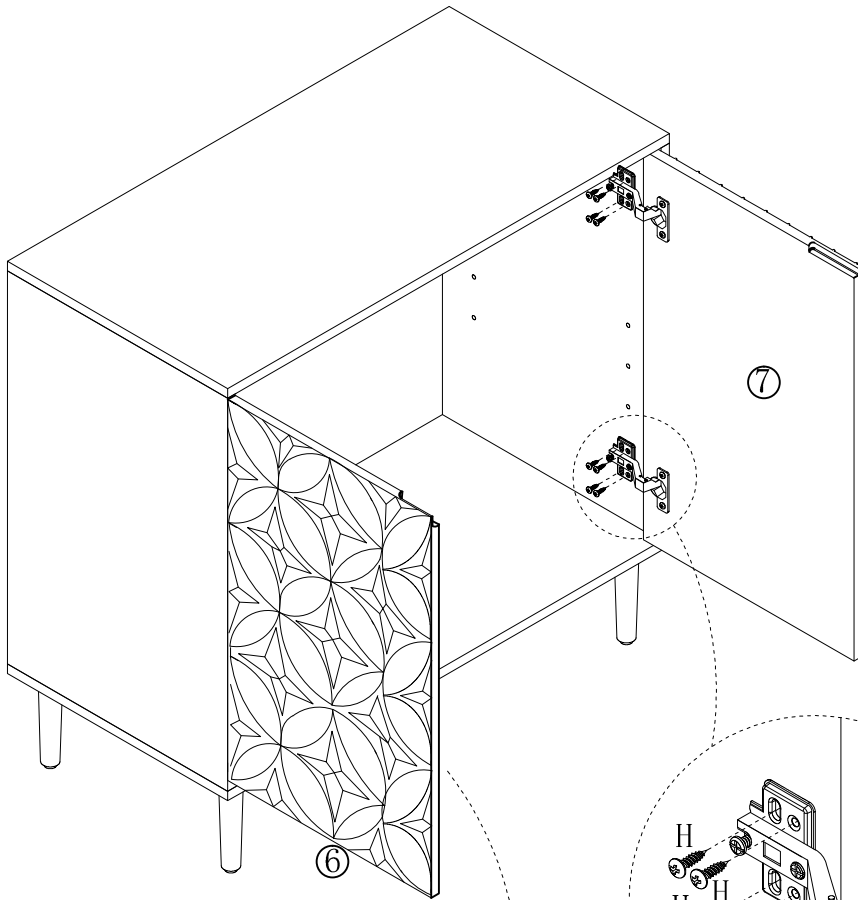

DOOR FITTING

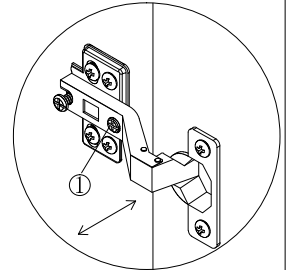

To adjust in width

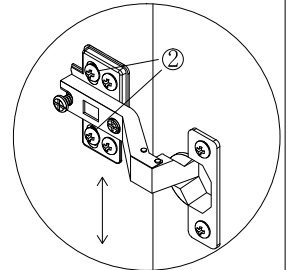

To adjust in height

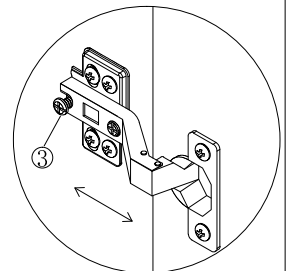

To adjust in depth

STEP 6

J:  4PCS

