

# installation instruction

Ø1220mm

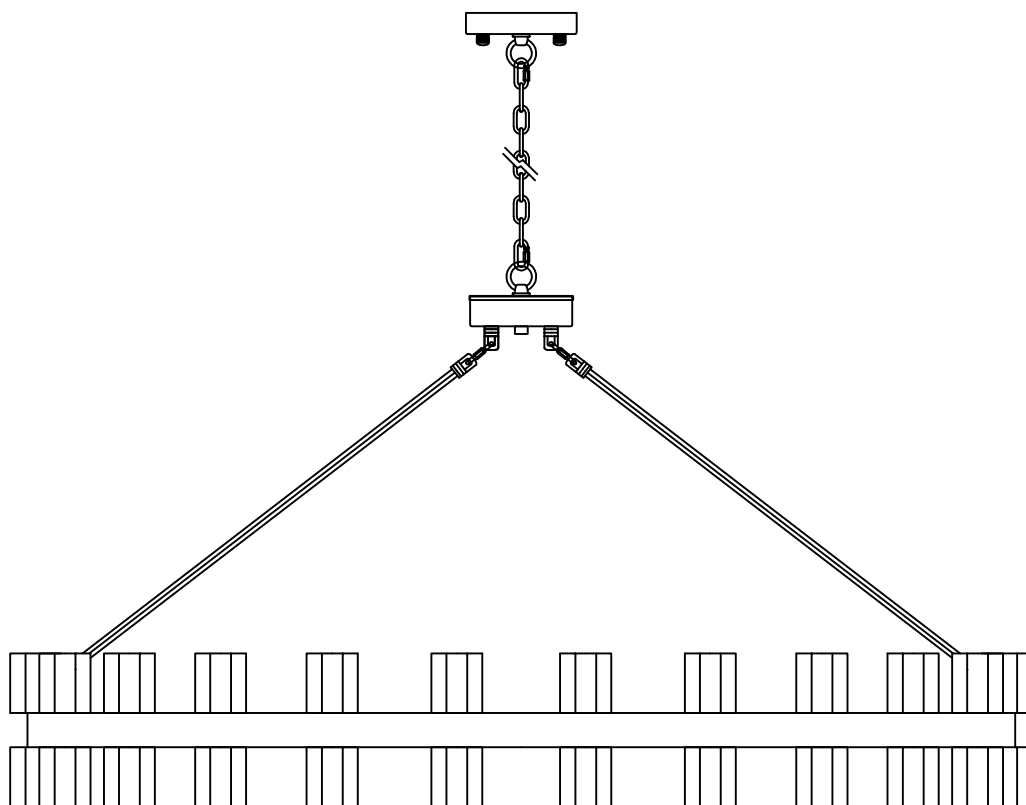

# Chandelier Installation and Safety Standards

The installation of a chandelier is a crucial step in ensuring its safety. Chandelier safety standards dictate the process of installation, including the tools and equipment that can be used, the methods of securing the chandelier, and the location of the chandelier.

Securing the chandelier is a crucial step in the installation process. Chandelier safety standards dictate that the chandelier must be securely attached to a suitable support, such as a ceiling joist, to prevent it from falling. This includes ensuring that the support is strong enough to bear the weight of the chandelier, and that the chandelier is properly balanced to prevent it from tipping or swaying.

Furthermore, the chandelier must be secured using suitable hardware, such as screws or bolts, that are strong enough to bear its weight. The hardware must be properly installed and tightened to ensure that the chandelier is securely attached. Regular inspections of the hardware are also necessary to detect and repair any damage or wear promptly.

## Packaging diagram:

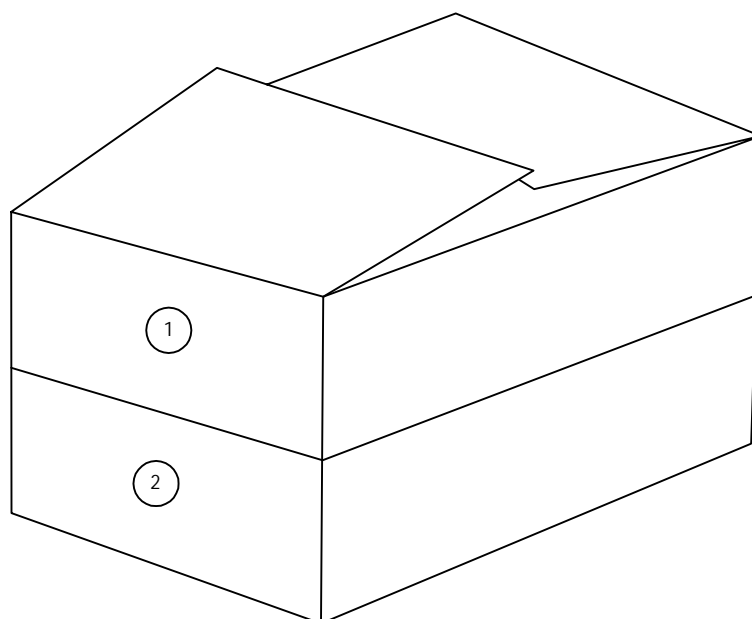

1

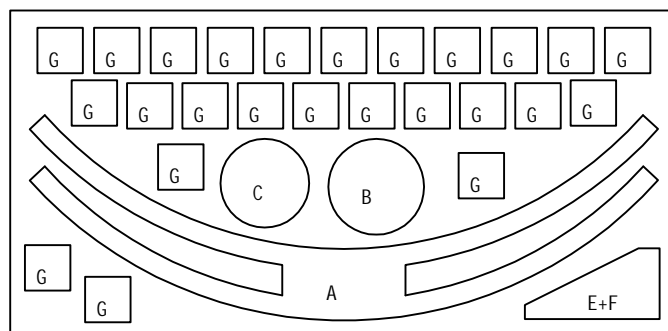

2

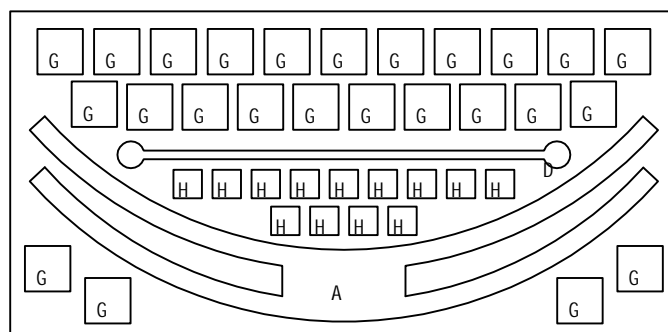

## Internal packing list:

1. First layer: lamp body + crystals + hanging chain + accessory pack
2. Second layer: lamp frame + crystals + pull rod round tube + light source

## Before assembly:

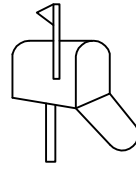

★Email:  
[Lighting@yxtservice.com](mailto:Lighting@yxtservice.com).  
If you have any questions,  
please feel free to contact us.  
Wishing you a pleasant day!

★ Please read all the instructions carefully

★ Keep the instruction manual for future reference.

★ Separate and inventory all parts and hardware

★ Read each step carefully and follow the correct installation sequence

★ To avoid losing any parts during assembly, we recommend not moving the lamp before completing the assembly. Always place the product on a flat, firm, and stable surface

★ Keep all small parts and packaging materials of this product away from babies and children, as they may cause serious injury



5-star rating

Thank you



### ★Product Parameters:

light: G4\*48pcs      watt: 3W (single)      color temperature: 3000K

## Installation video and product website:

YouTube URL: [https://www.youtube.com/watch?v=q\\_bmsjw2lbY](https://www.youtube.com/watch?v=q_bmsjw2lbY)

Scan the QR code to view:



# Accessory List:



2pcs



4pcs



2+2pcs

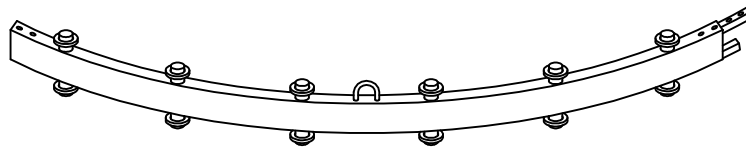

A. main lamp stand-4pcs

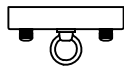

B. canopy-1pcs



C. main lamp stand-1pcs

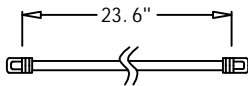

D. Pull rod round tube-4pcs

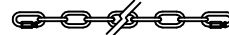

E. chain-1+1+1pcs

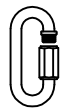

F. ring lock buckle-8+1pcs



G. crystal -48+2pcs

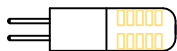

H. light source-48+2pcs

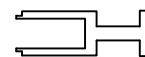

I. Clamping wrench-2pcs

## ①Lamp body assembly:

1. Find the lamp body from the sorting list.
2. Assemble lamp body A according to the diagram and connect the assembly plug.
3. Twist off the round ring clip on the lamp body, assemble the G crystals according to the diagram, and tighten the round ring clip. Insert the 48 G4 light bulbs into the lamp holder (as shown in the diagram).
4. Take out the pull rod round tube, pass the power cord through the tube, use the lock clip to connect lamp body A to lamp body C, and insert the power cord into lamp body C, connecting it to the main power line inside lamp body C.
5. Connect the power cord inside the lamp body to the main power line, and pass the lamp's main power line through the suspension chain into the ceiling plate.

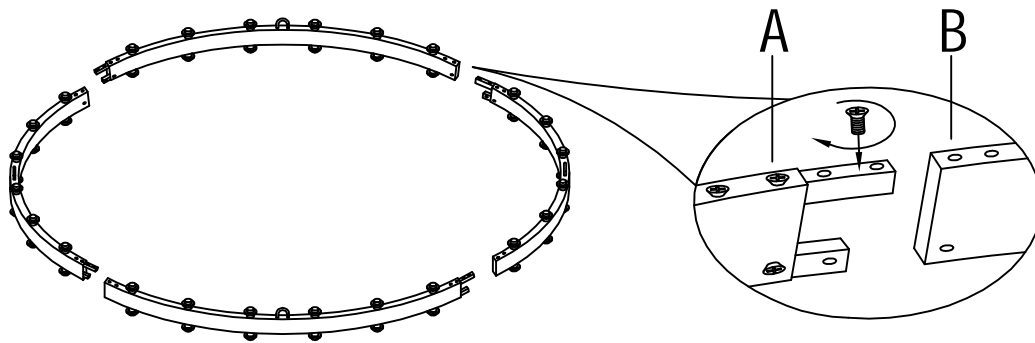

If the circular hole position of the screw installation cannot be aligned with accessory B, please loosen the screw of model A, insert the accessory of model B again and align the circular hole position. then tighten the screw.

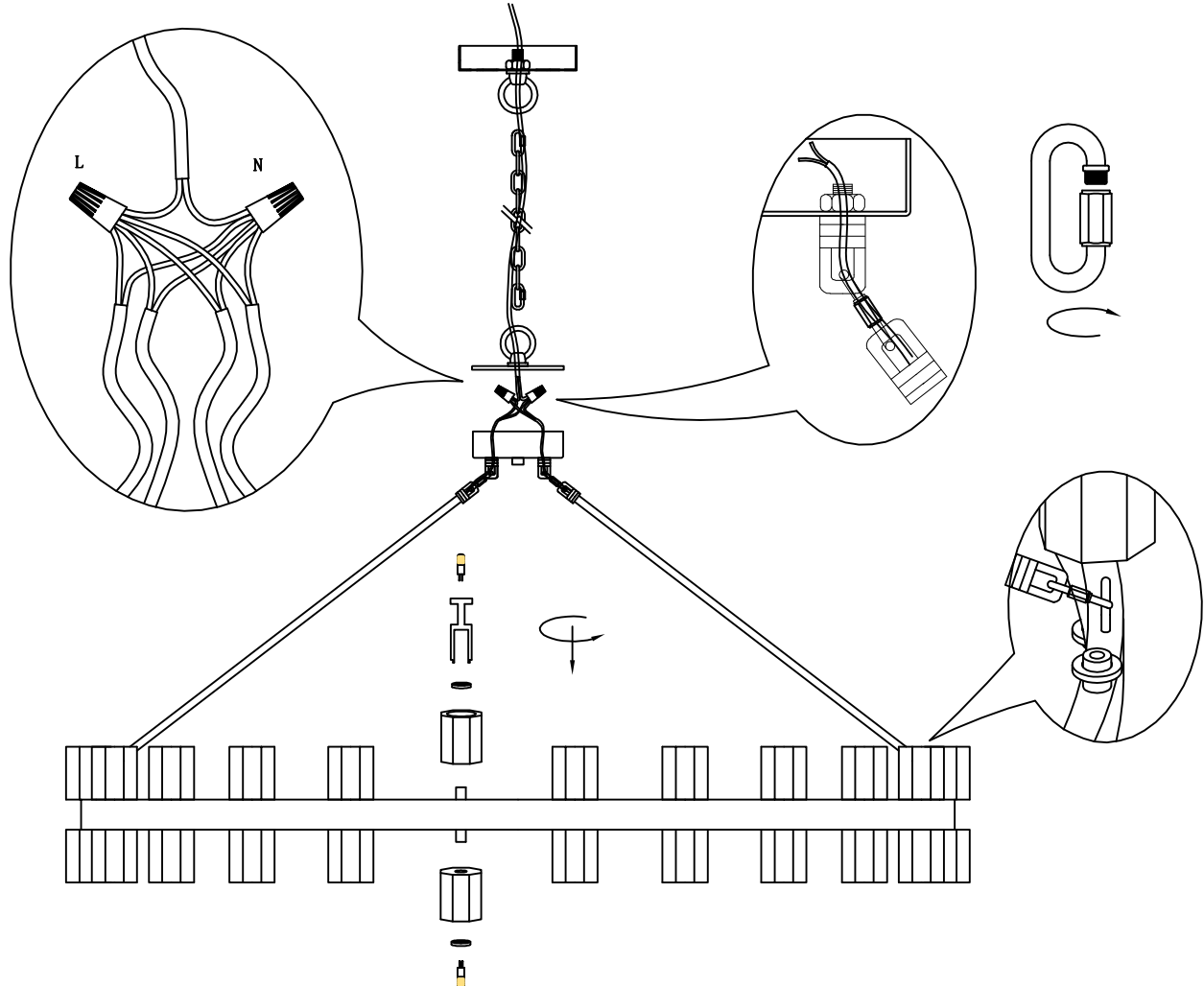

## ②Lamp body assembly:

1. Take out the mounting plate and attach it to the wall.
2. Connect the main power wire to the lamp's main wire, and secure the ceiling plate.
3. Installation complete.

