







ASSEMBLY INSTRUCTIONS

 A M3.5*55 12PCS	 B M3.5*40 7PCS	 C M3.5*30 18PCS	 D M3.0*25 70PCS
 E M6.0*60 20PCS	 F M8.0*30 2PCS	 M3.0*16 12PCS  G 3PCS	

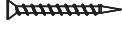
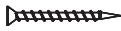

STEP 1

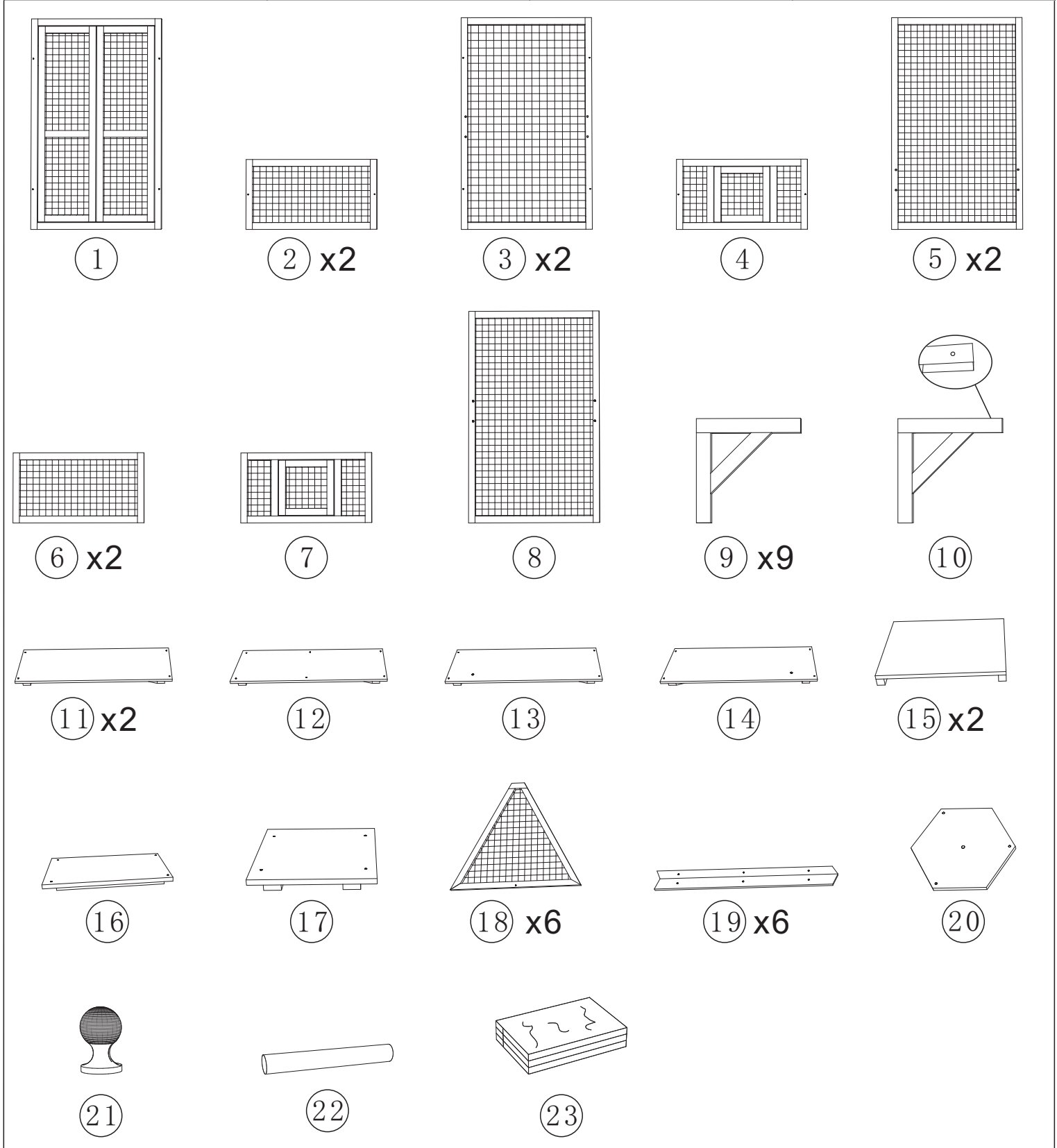
Ax2
Ex4

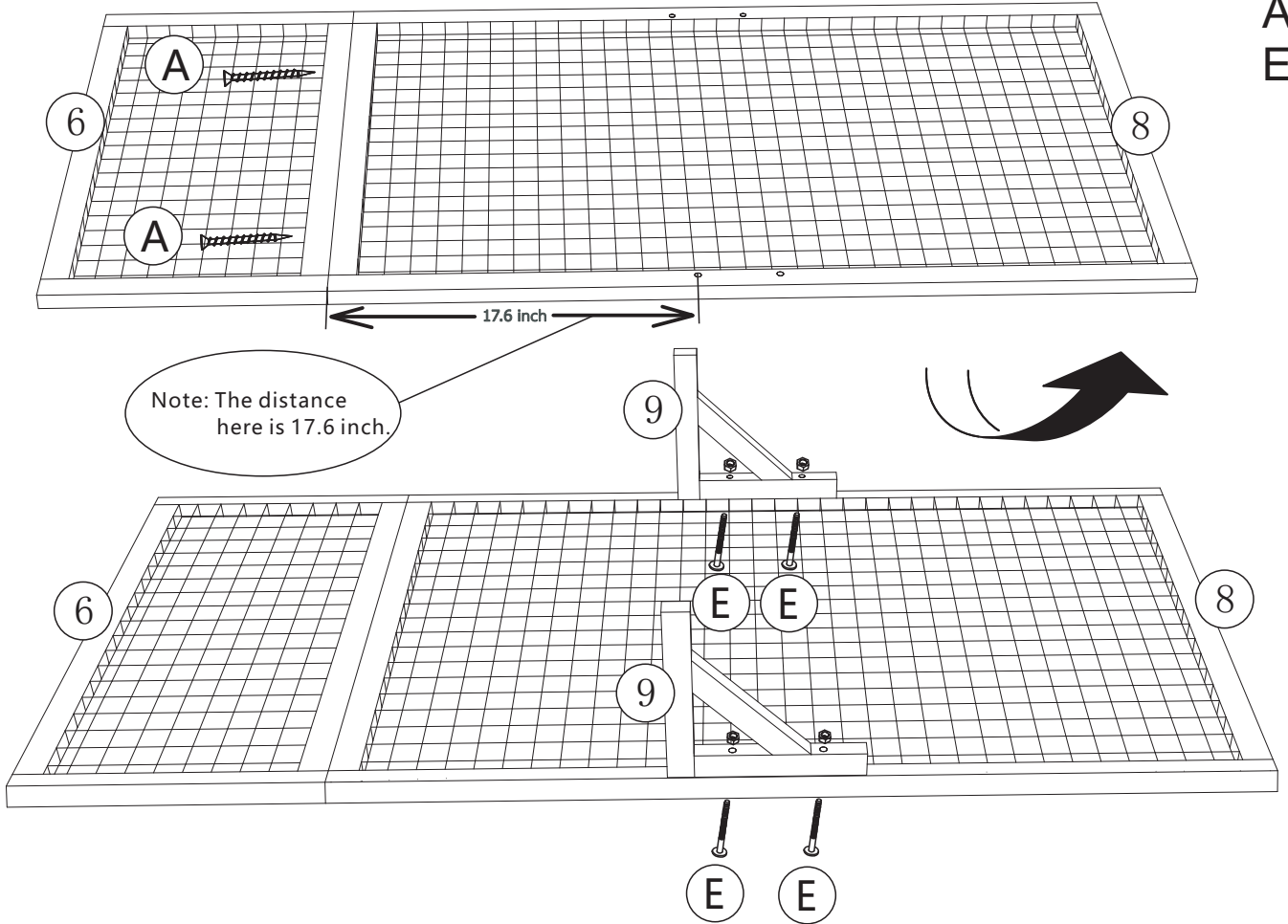

STEP 2

Ax2
Ex4

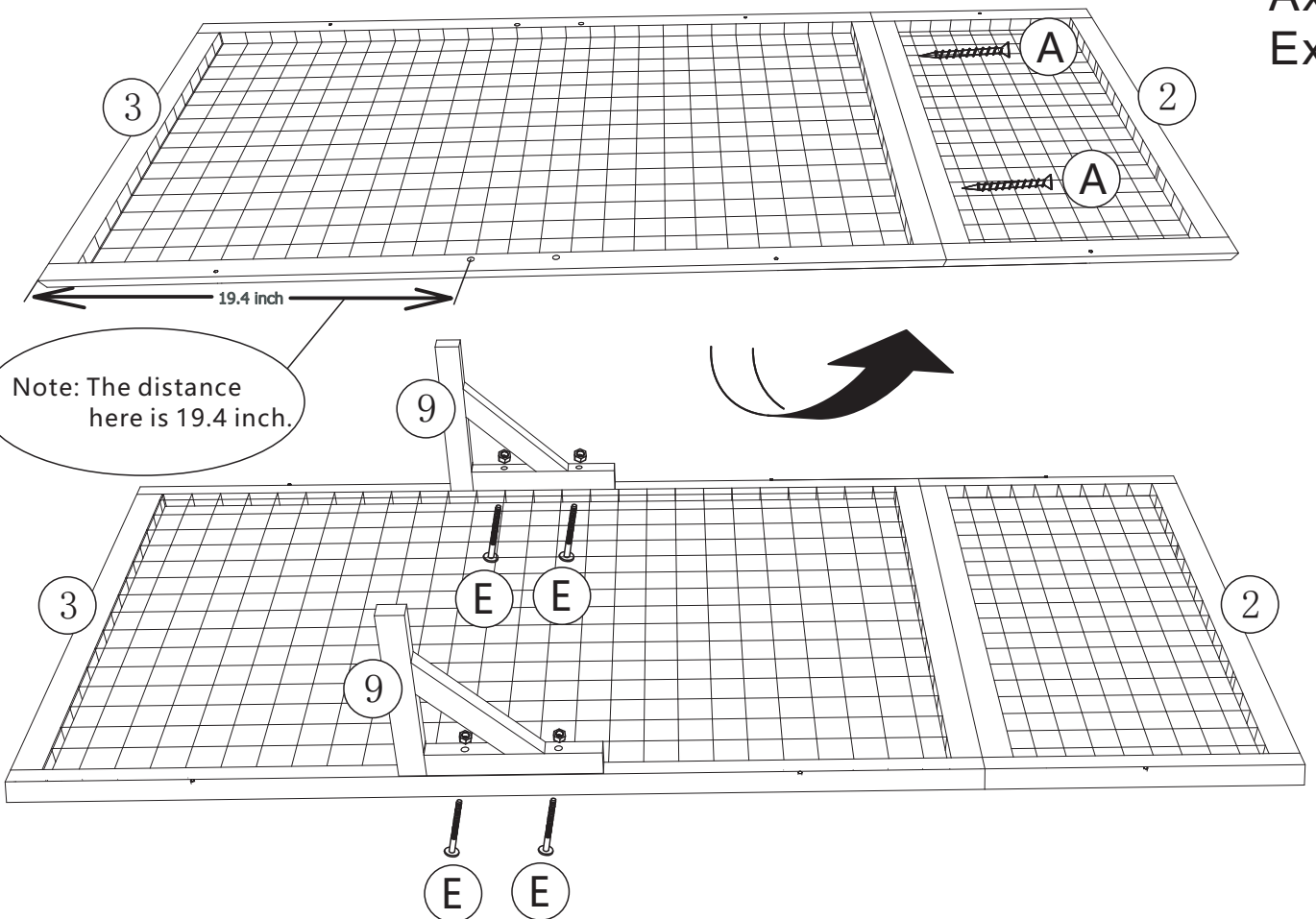

STEP 3

Ax2
Ex4
Gx1

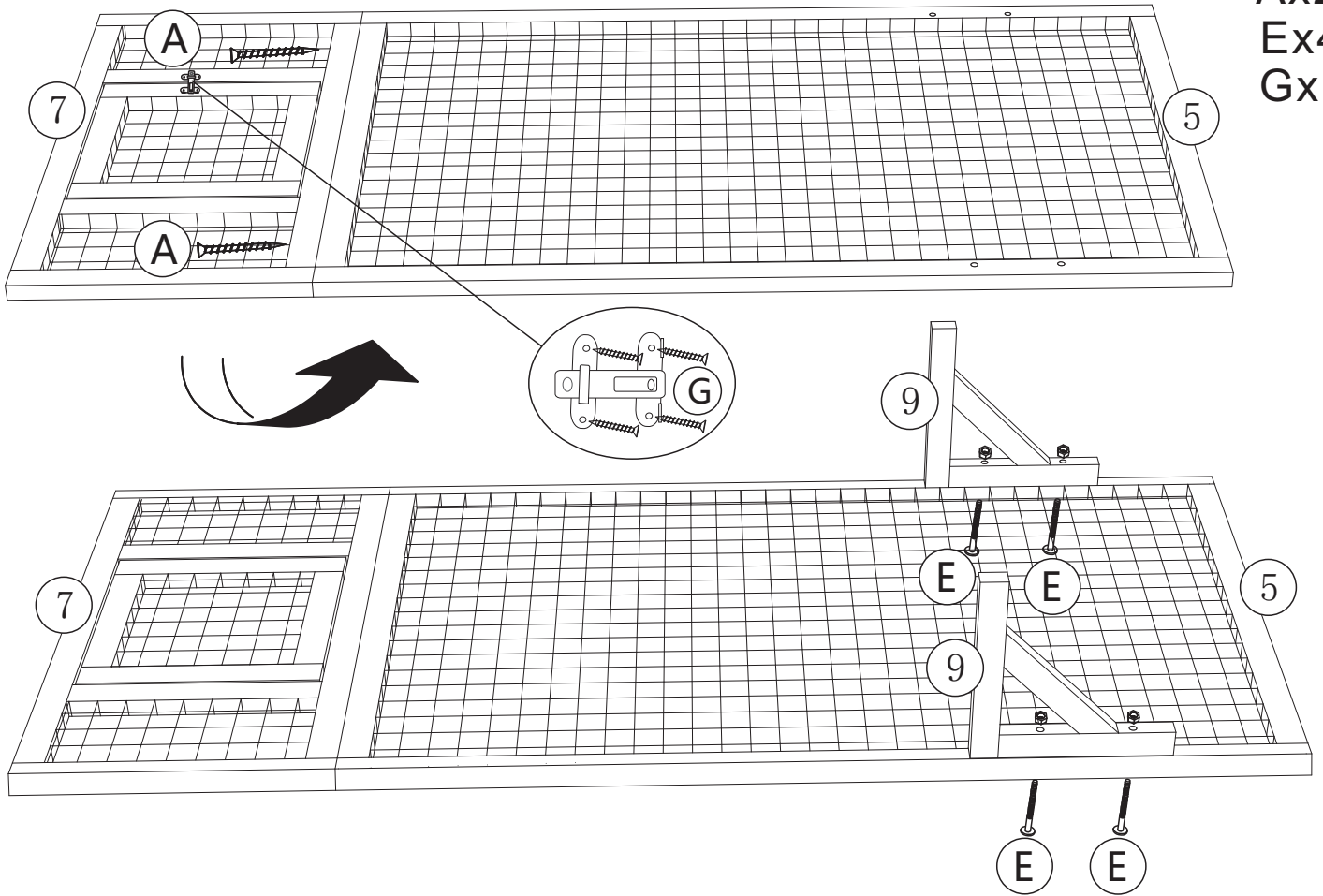

STEP 4

Ax2
Ex4

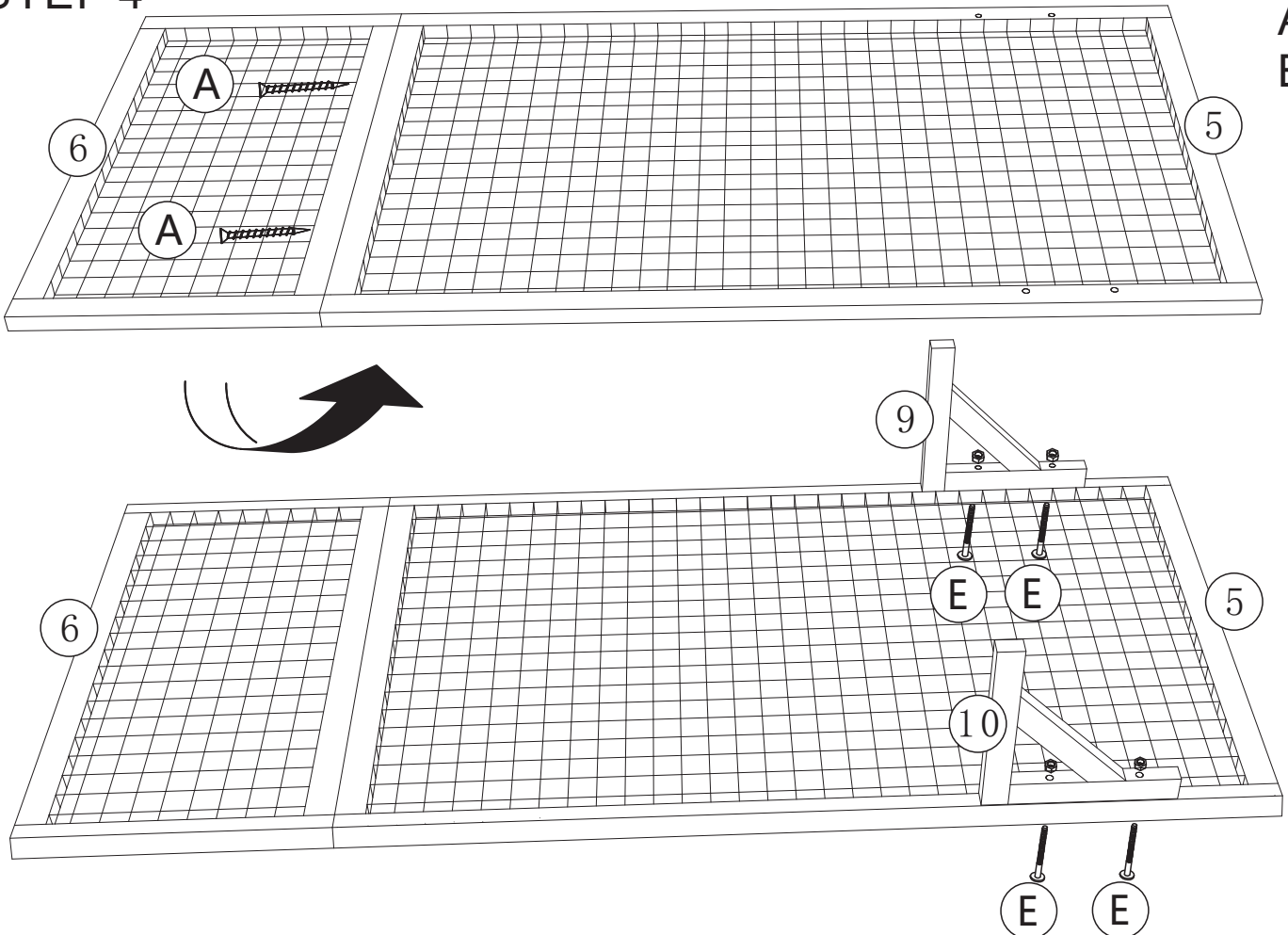

STEP 5

Ax2
Ex4
Gx1

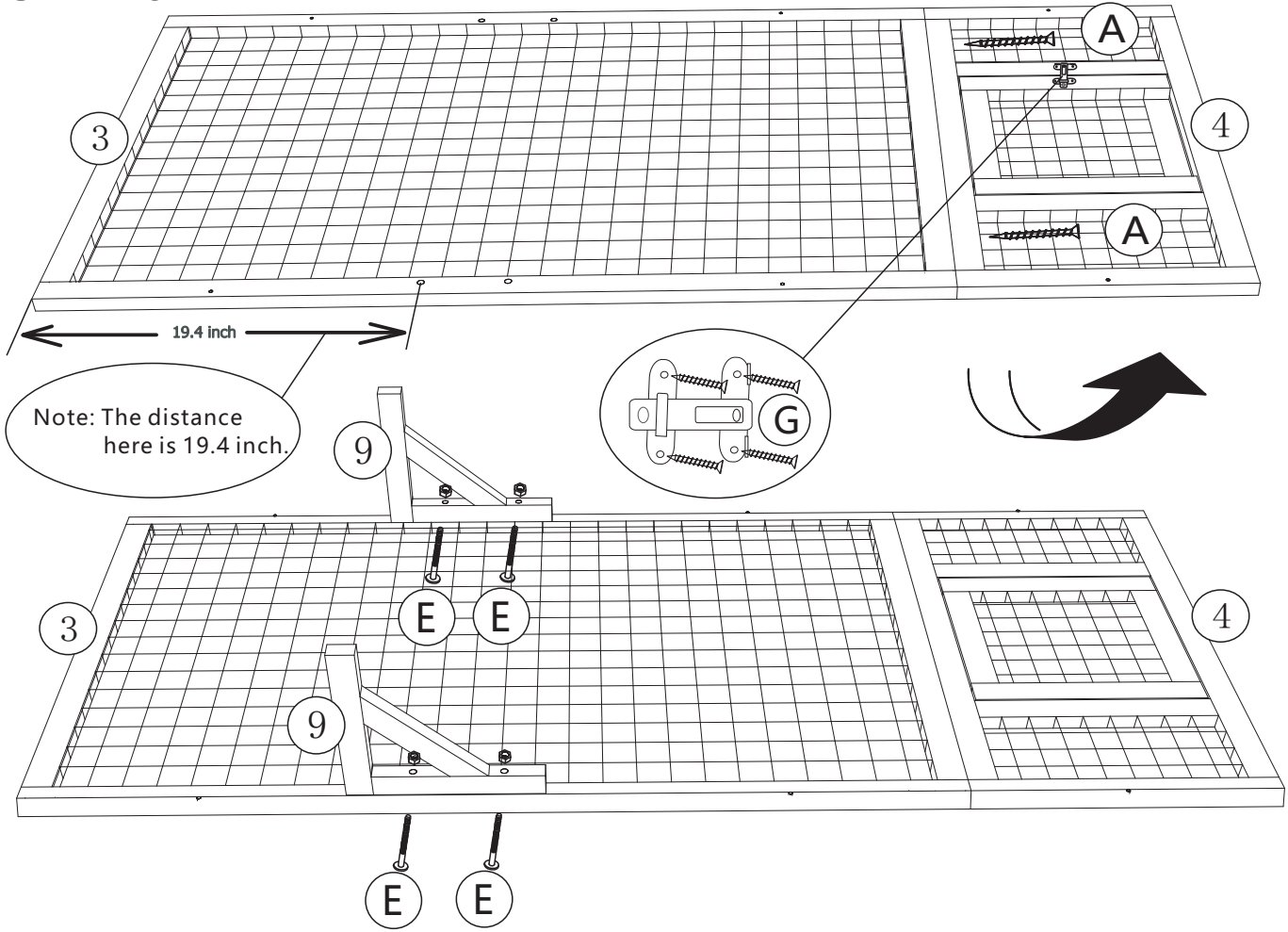

STEP 6

Ax2
Gx1

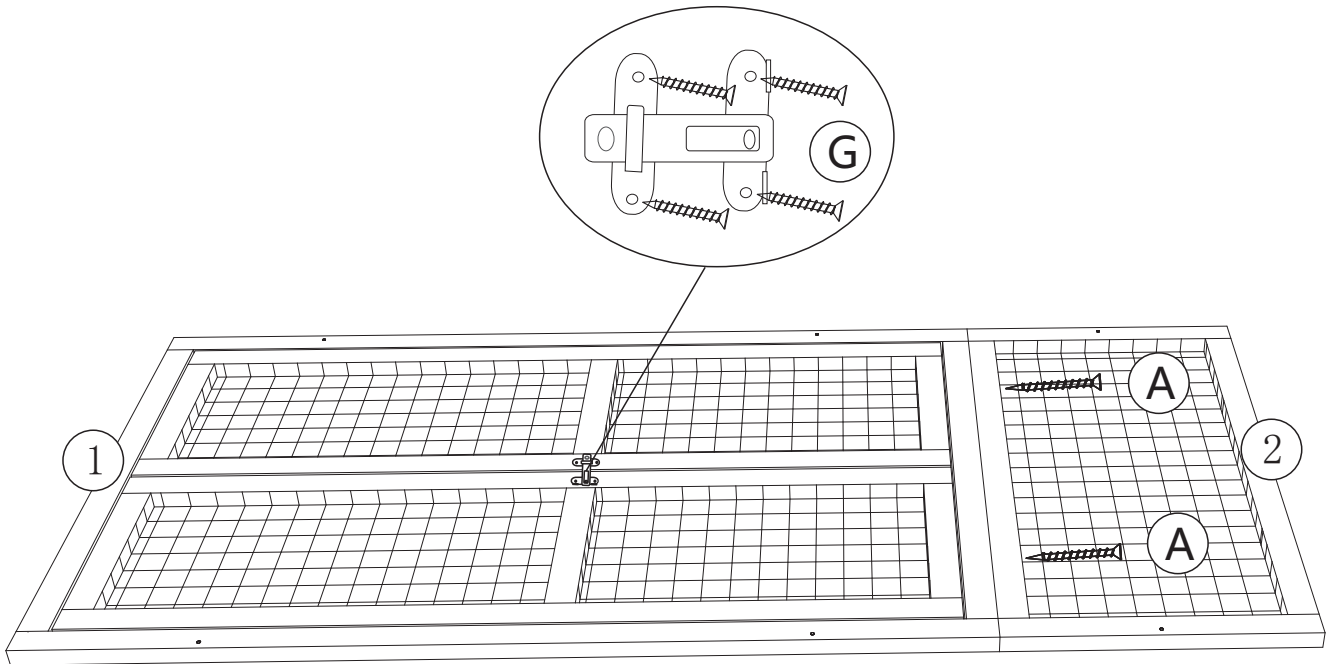

STEP 7

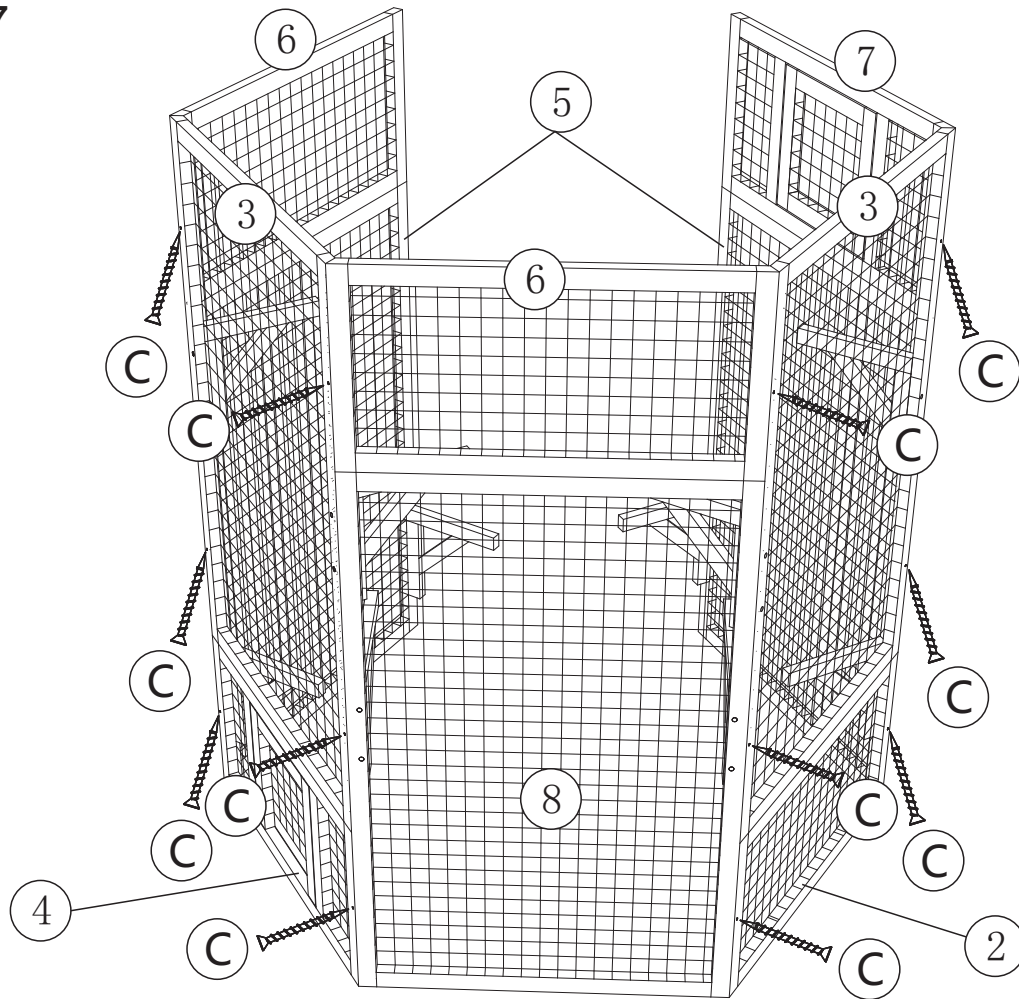

STEP 8

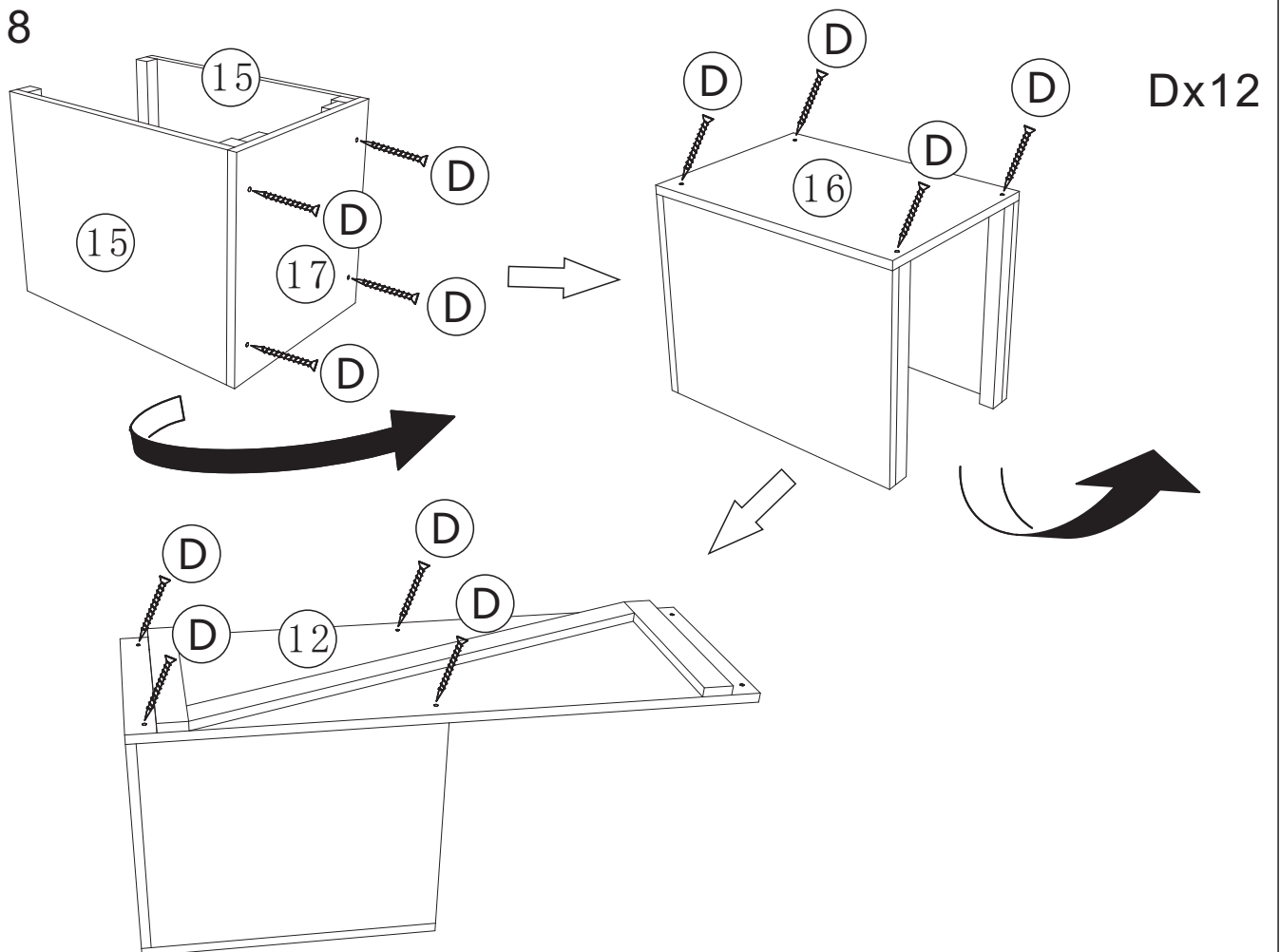

STEP 9

Fx2
Bx1
Dx18

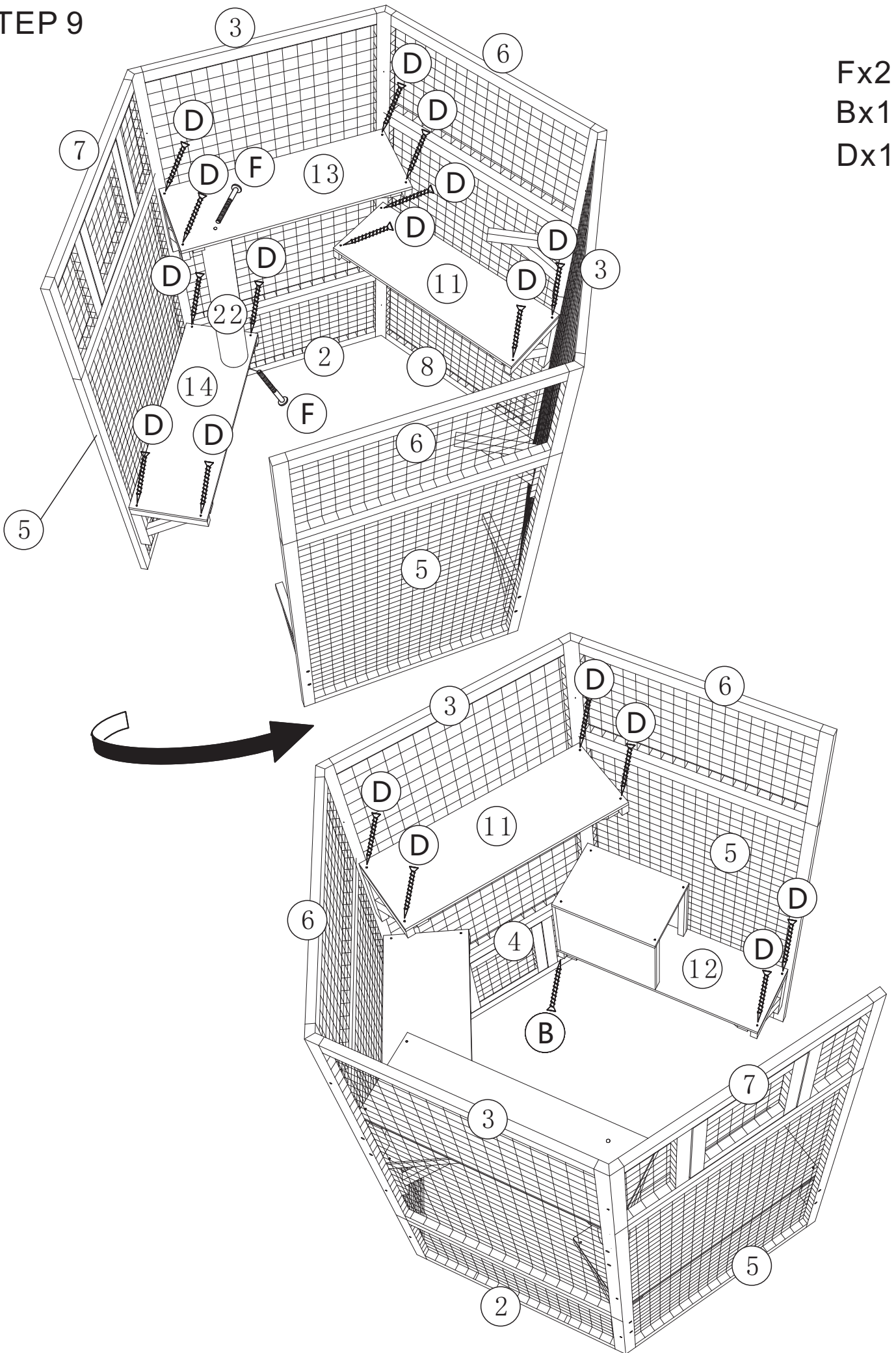

STEP 10

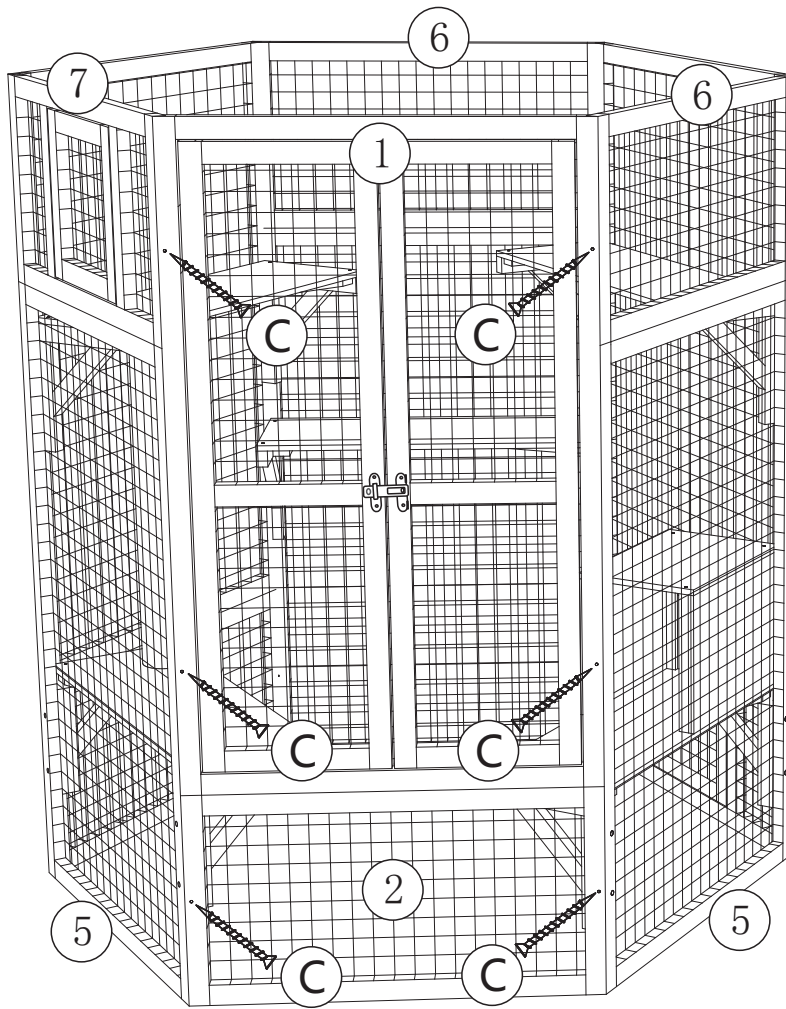

Cx6

STEP 11

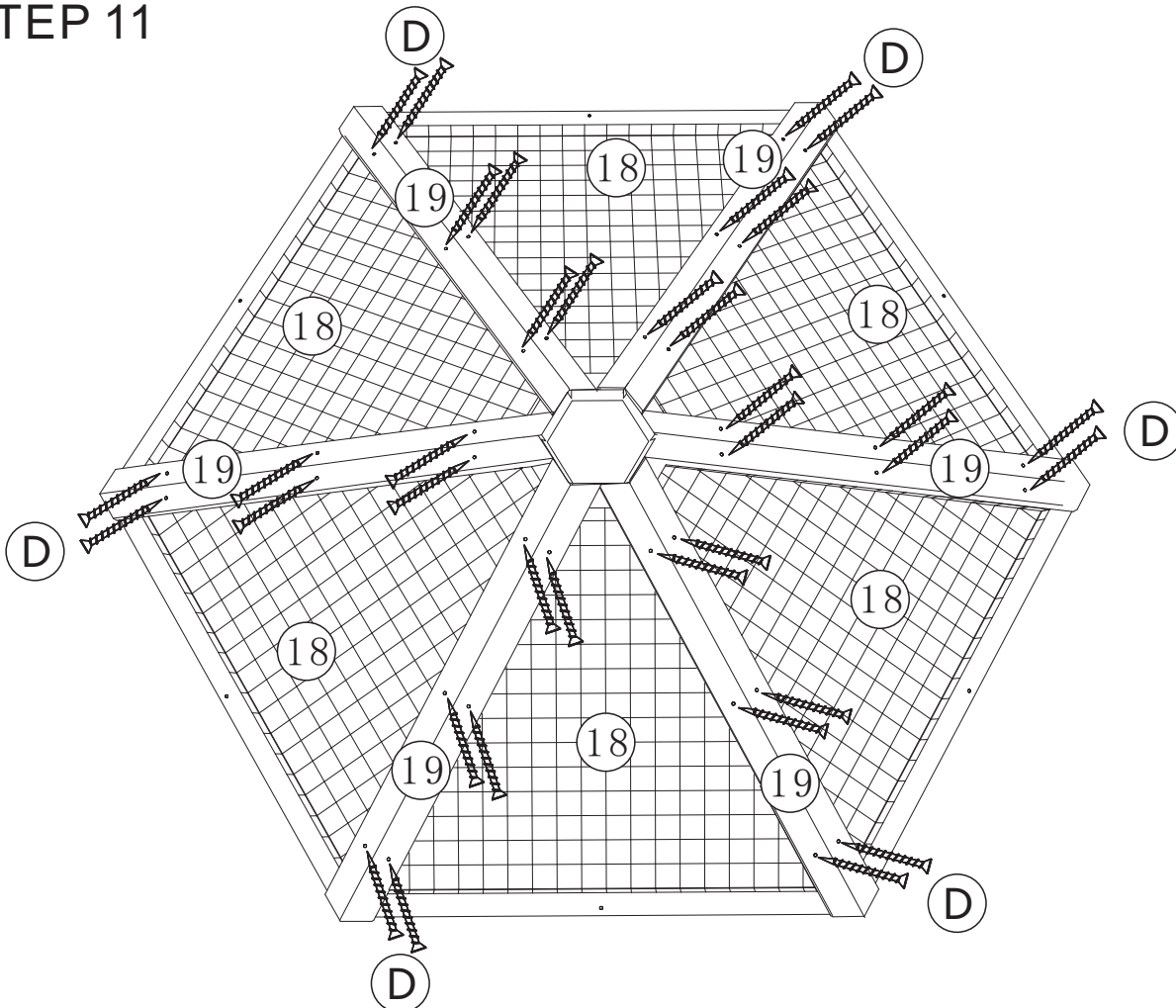

Dx36

STEP 12

Dx1

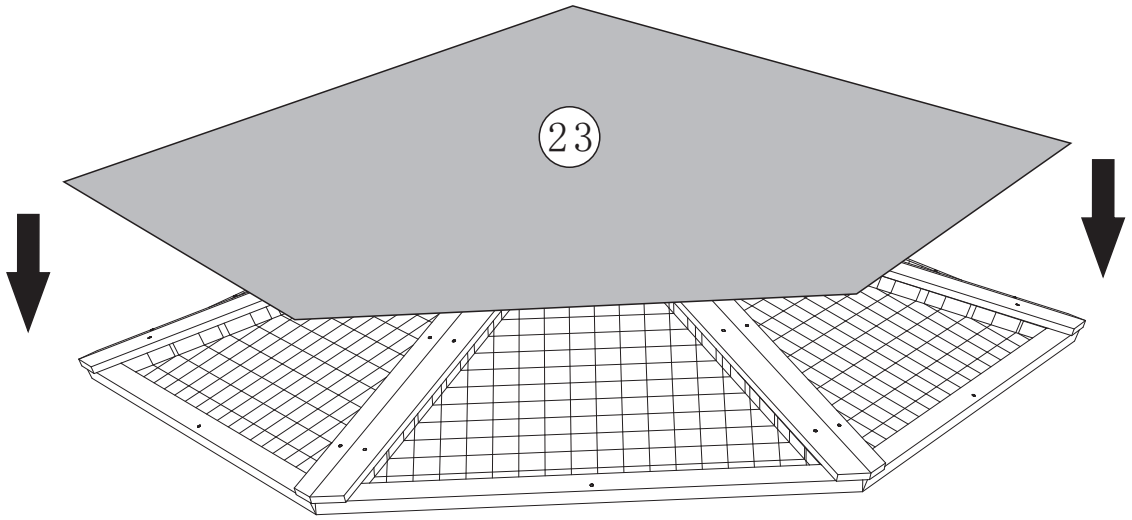
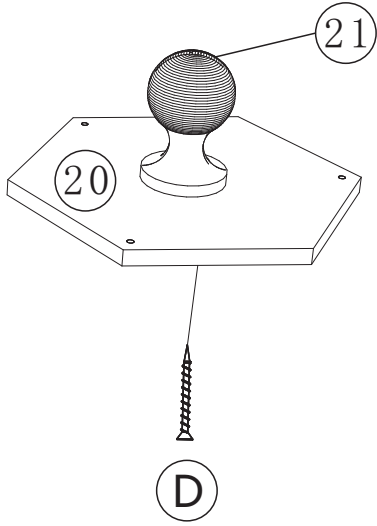

STEP 13

Dx3

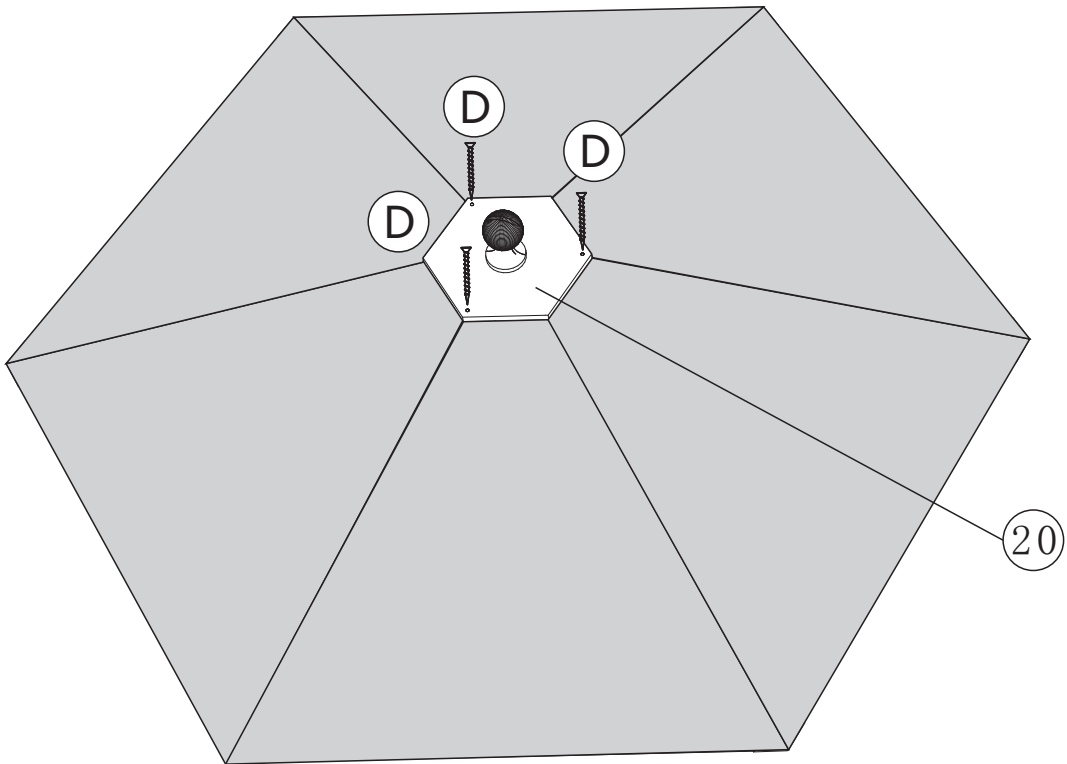

STEP 14

Bx6

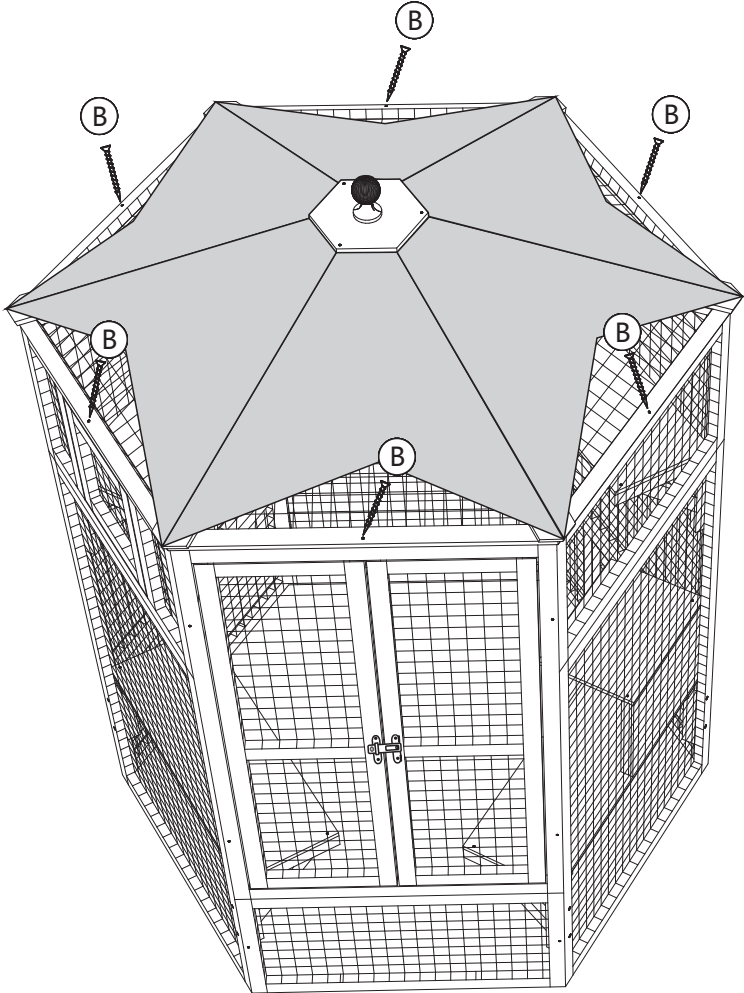

STEP 15

