

LUXURY SOFA

Instruction manual

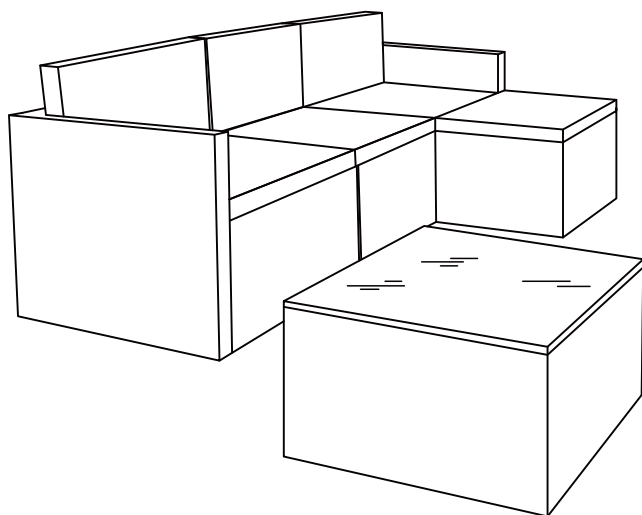

CONTENTS

Safety and care advice	1
Components – panels	2
Components – fittings	3
Assembly instructions	4
Copyright	13

⚠️ SAFETY AND CARE ADVICE ⚠️

PLEASE READ THESE INSTRUCTIONS CAREFULLY AND KEEP FOR FUTURE REFERENCE

- **Warning:** This unit weighs approximately 75kgs. Please lift with care.
- Check you have all the components and tools listed on pages 2 and 3.
- Remove all fittings from the plastic bags and separate them into their groups.
- Keep children and animals away from the work area, small parts could choke if swallowed.
- Make sure you have enough space to layout the parts before starting.
- Do not stand or put weight on the product, this could cause damage.
- Assemble the item as close to its final position (in the same room) as possible.

- Assemble on a soft level surface to avoid damaging the unit or your floor (use opened out unit carton).



- We do not recommend the use of power drill/drivers **for inserting screws**, as this could damage the unit. Only use hand screwdrivers.
- **Safety note:** If there is any chance of this unit being pulled over by children etc. it is recommended that the unit is secured to a wall using suitable fixings.
- Dispose of all packaging carefully and responsibly.

CARE AND MAINTENANCE

- Only clean using a damp cloth and mild detergent, do not use bleach or abrasive cleaners.
- From time to time check that there are no loose screws on this unit.

- This product should not be discarded with household waste. Take to your local authority waste disposal center.

Note If required the next page can be cut out and used as reference throughout the assembly. Keep this page with these instructions for future reference.

COMPONENTS

Ensure the following components are in the box before proceeding with assembly:



A x1

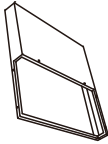

B x1



C x1

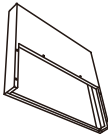

D x1



E x1

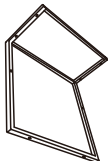

F x1

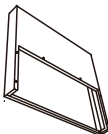

G x1



H x1



I x1

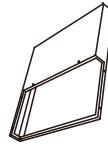

J x1



K x1

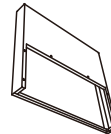

L x1



M x1



COMPONENTS

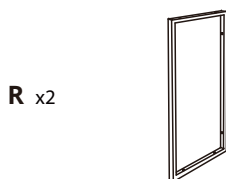
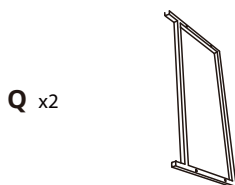
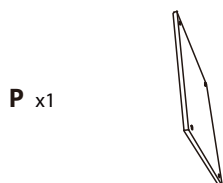
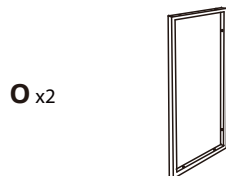
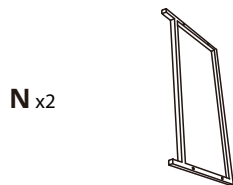



ASSEMBLY INSTRUCTIONS

Please note, When building this product bolts should be finger tightened until all parts are in place. Only once all parts and bolts are assembled should bolts them be fully tightened using the ratchet.



Step 1

Left Side Sofa

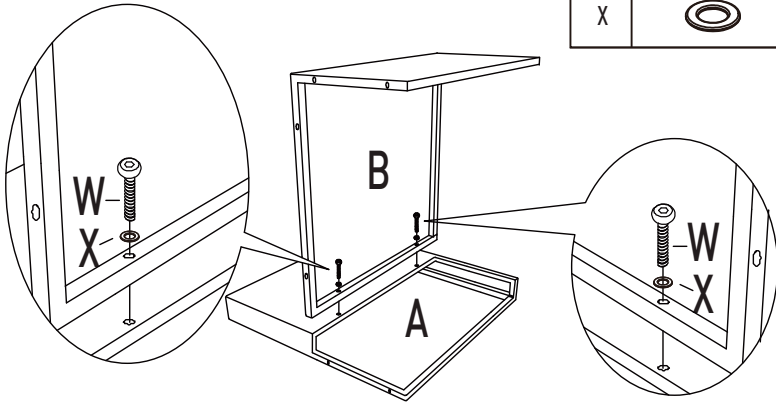
V		1
W		2
X		2



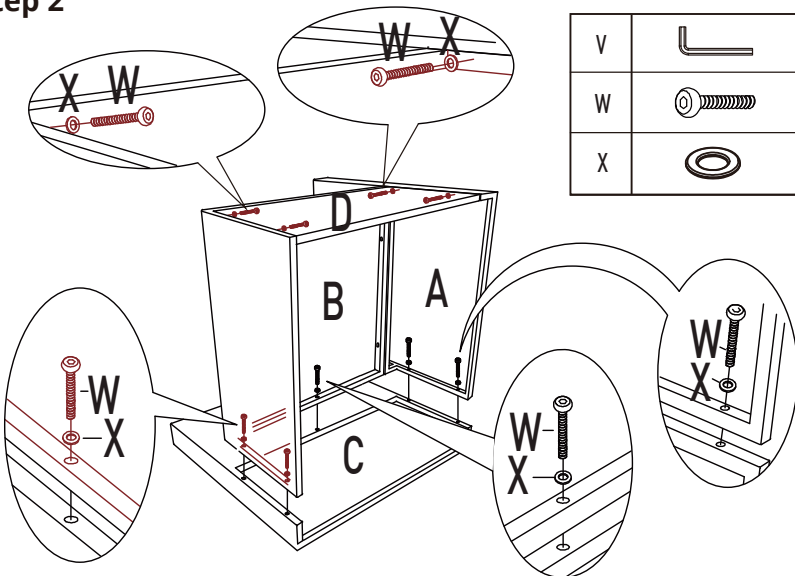

Step 2

V		1
W		9
X		9



ASSEMBLY INSTRUCTIONS

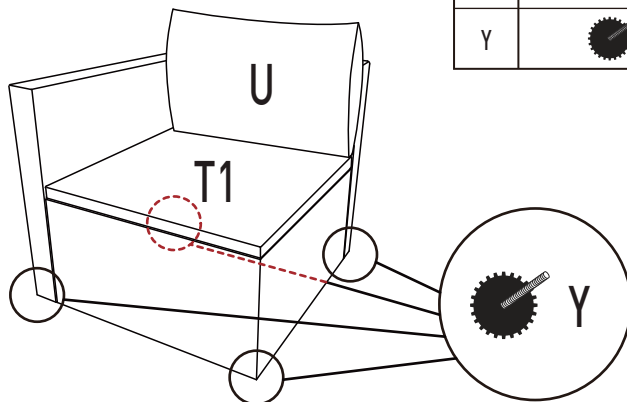

Step 3

T1		1
U		1
Y		4



Step 4

Rattan Center Sofa

V		1
W		4
X		4

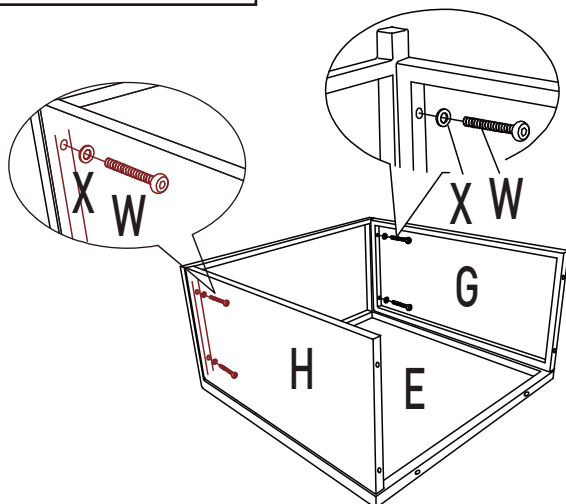

ASSEMBLY INSTRUCTIONS

Step 5

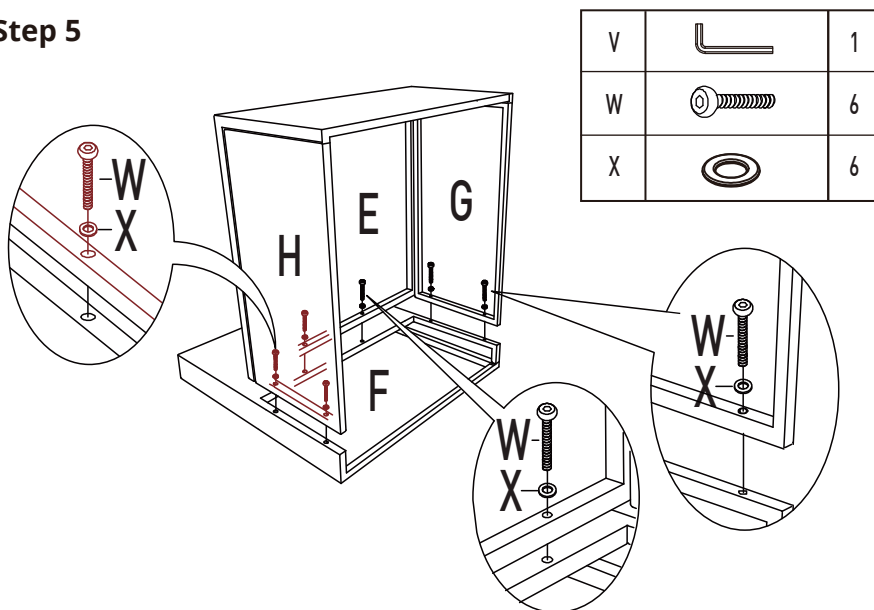

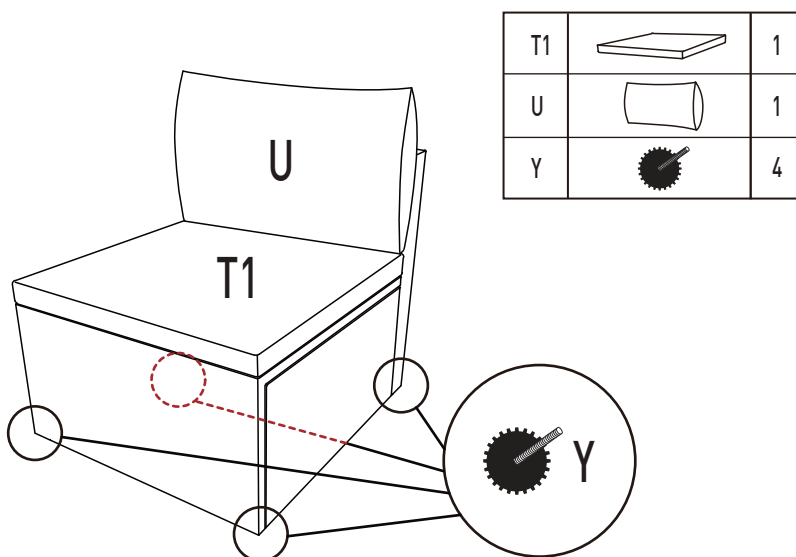

Step 6



ASSEMBLY INSTRUCTIONS



Step 7

Right Side Sofa

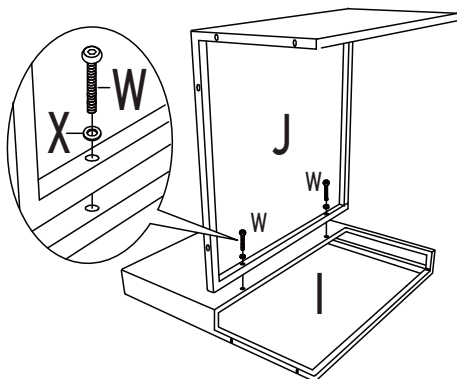
V		1
W		2
X		2



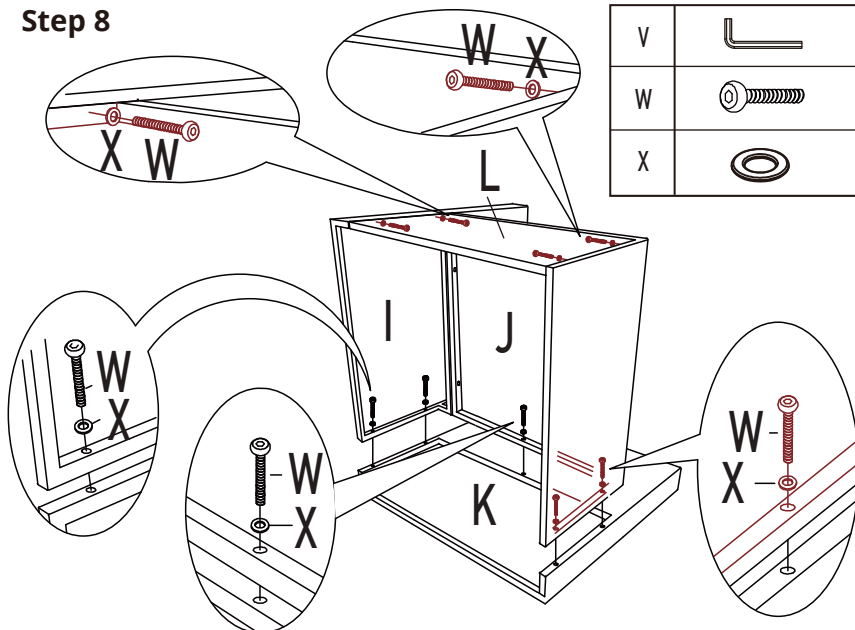

Step 8

V		1
W		9
X		9



ASSEMBLY INSTRUCTIONS

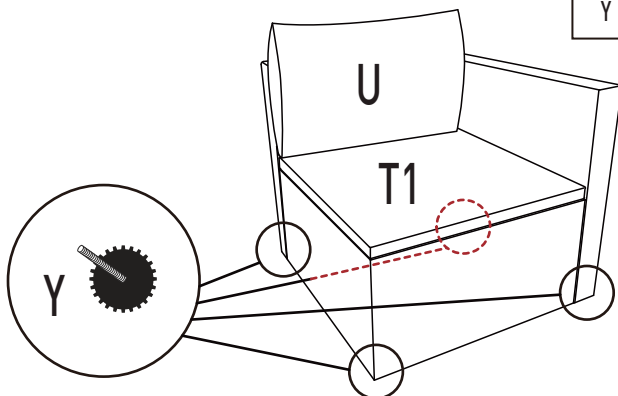

Step 9

T1		1
U		1
Y		4



Step 10

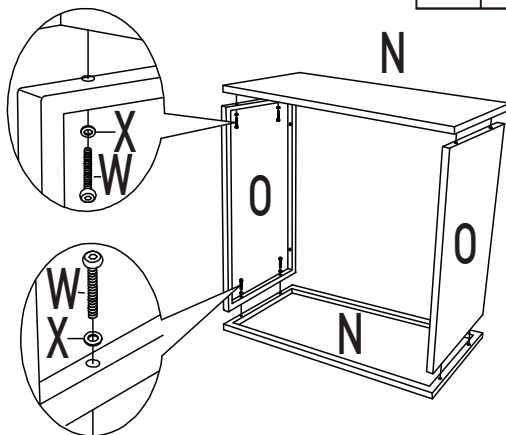

Rattan Stool

V		1
W		8
X		8





ASSEMBLY INSTRUCTIONS

Step 11

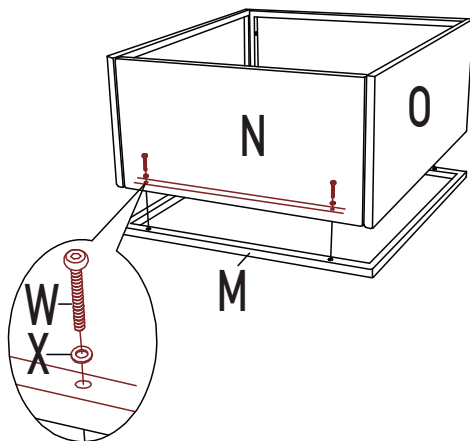
V		1
W		4
X		4



Step 12

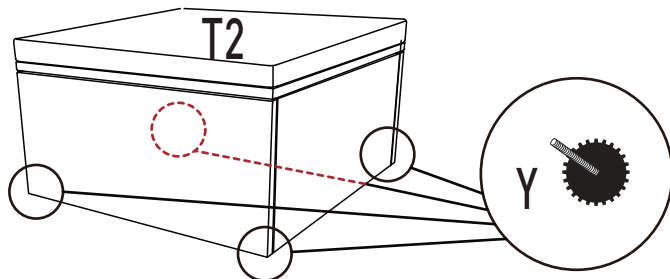

T2		1
Y		4



ASSEMBLY INSTRUCTIONS



Step 13

Rattan Center Table

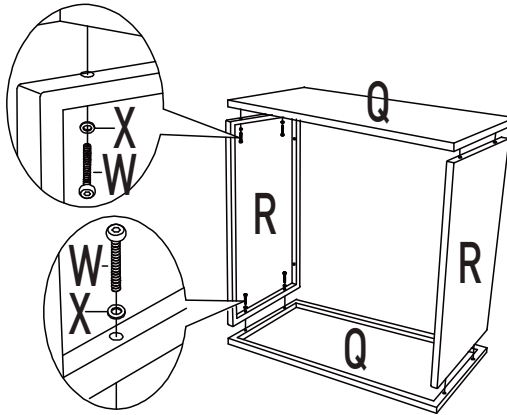
V		1
W		8
X		8



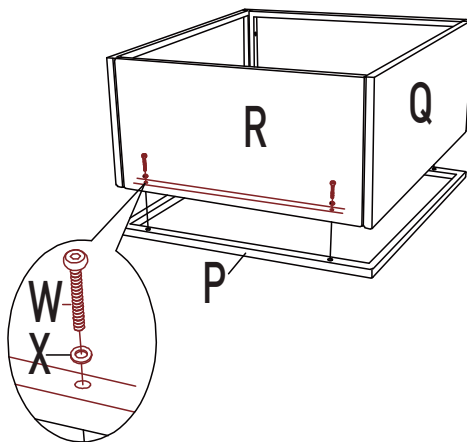

Step 14

V		1
W		4
X		4



ASSEMBLY INSTRUCTIONS

Step 15

S		1
Y		4

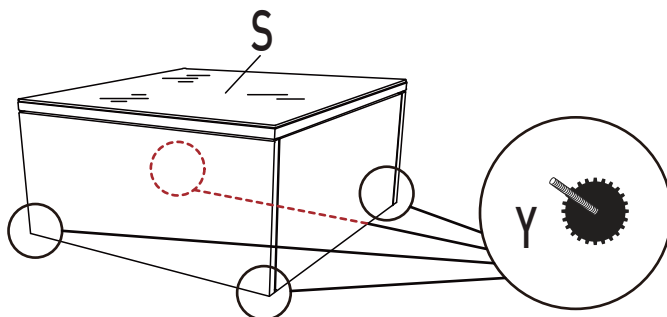

Step 16

Z		3
---	---	---

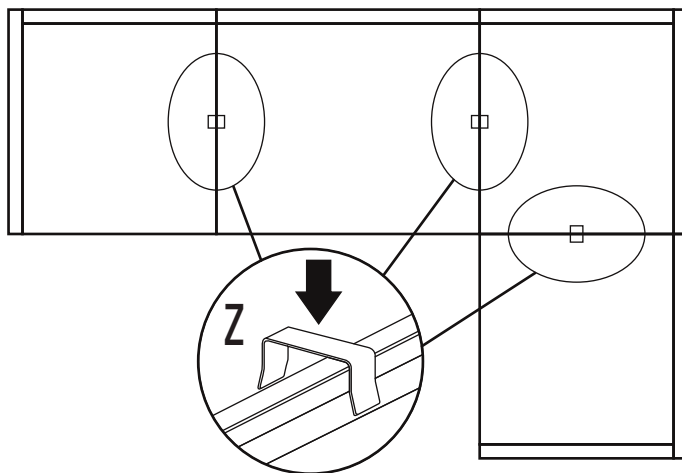

ASSEMBLY INSTRUCTIONS

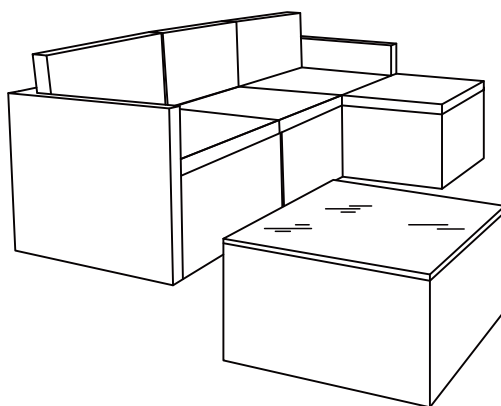

Congratulations! Now you have finished assembling the product. There may be some dust or hand marks on your item, we recommend using a standard wood polish to clean this product.

IF YOU FIND A DEFECTIVE PART

We fully stock all parts and components. Any defective part can be quickly replaced. Take note of the defective part number in manual and we will arrange a replacement.

COPYRIGHT

All material in this instruction manual is copyrighted .

Any unauthorised use may violate worldwide copyright, trademark and other laws.