





Accent Chair Assembly Instructions

Your accent chair comes packaged in one box.

DO NOT use any sharp objects to open plastic wrapped components as damage to product or components may result.

Carefully remove all of the components from the packaging and set aside for assembly. Assemble on a soft surface to prevent scratching the finish.

A  1PC	B  2PC	C  2PC	D  4PC	E  1PC
--	--	--	--	--

Assembly

Step 1

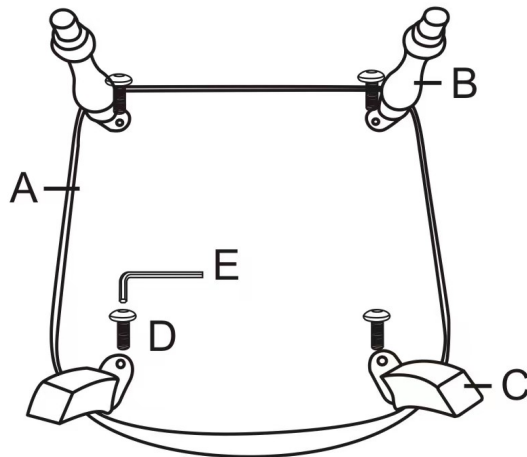

Step 2

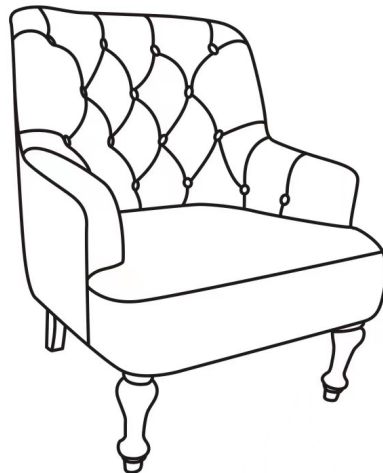

Your accent chair style may differ from images. Care for your furniture by periodically tightening all legs. Fabric will fade or discolor in direct sunlight. Minimize exposure to direct sunlight to extend the life of your furniture.