

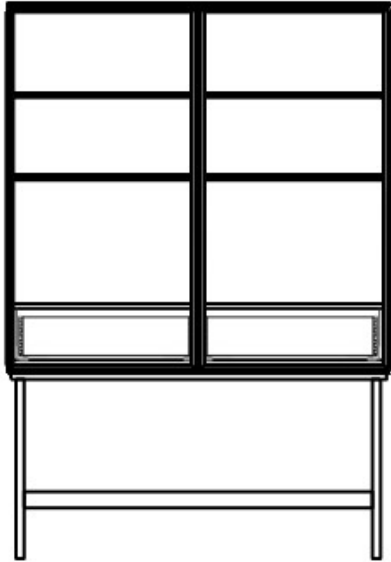



ASSEMBLY INSTRUCTION FOR: HAYWARD CABINET



Hardware List			
	Description	Size	Qty
	Screw		14
	Adjustable Leveler	17 x 30mm	4
	Anti tip kit		2

1 To attach the base, adjust the screws in the base's bores with a screwdriver or drill

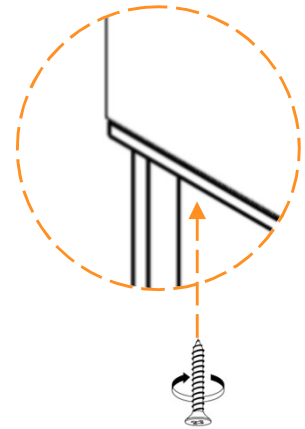
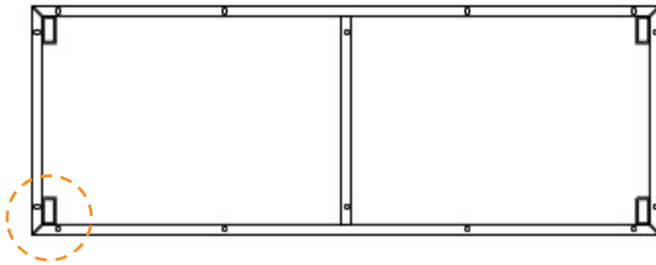

2 To level, use a wrench (not included)

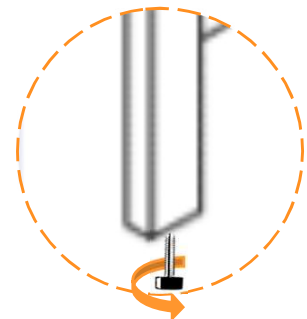
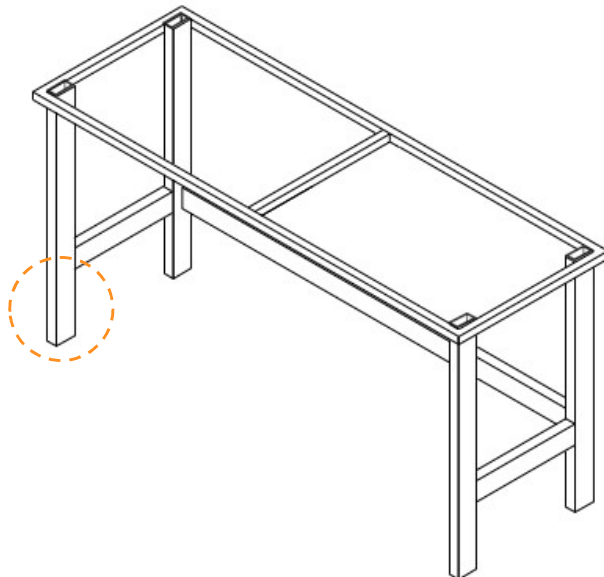

ASSEMBLY INSTRUCTION FOR: Hayward Cabinet

- 3 2 Anti-tip kit are included. Read the instructions carefully and install them immediately on the back of the countertop where indicated

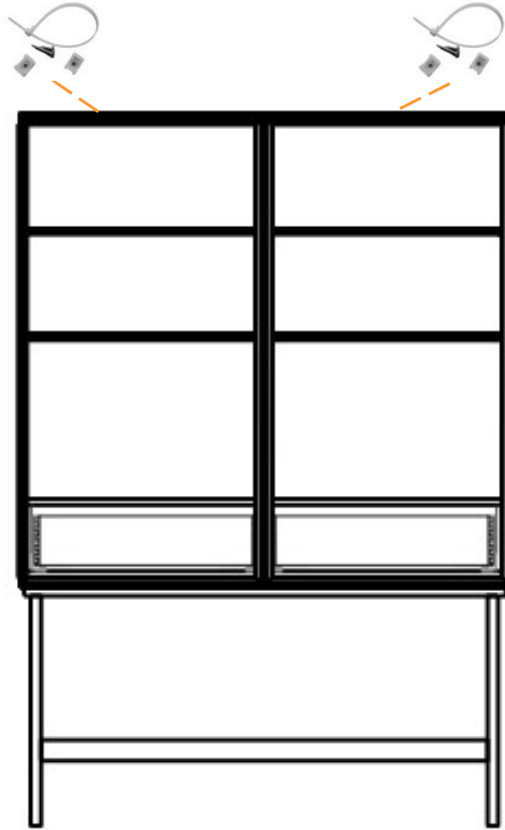

- 4 With open doors, place the shelf at an angle and place it on the wood profile

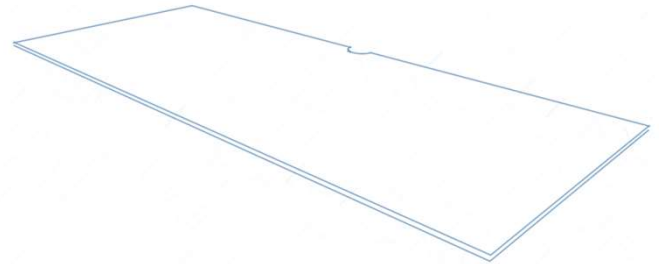
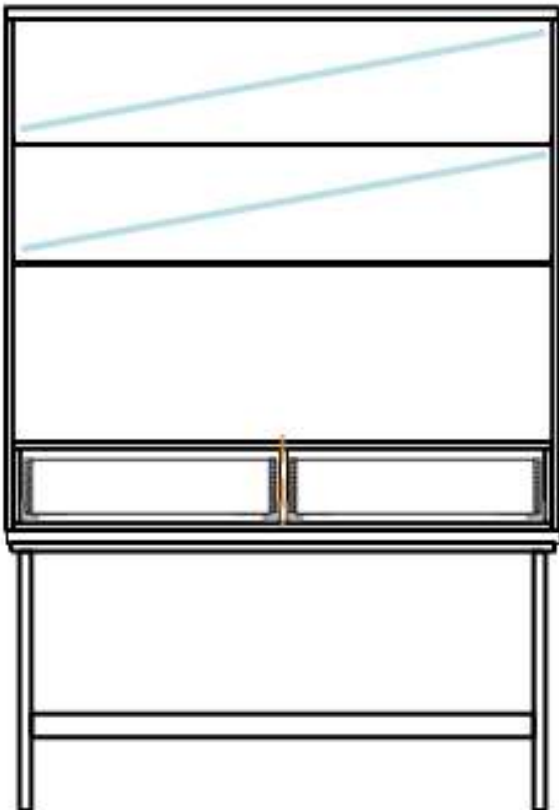

x2