

ASSEMBLY INSTRUCTIONS

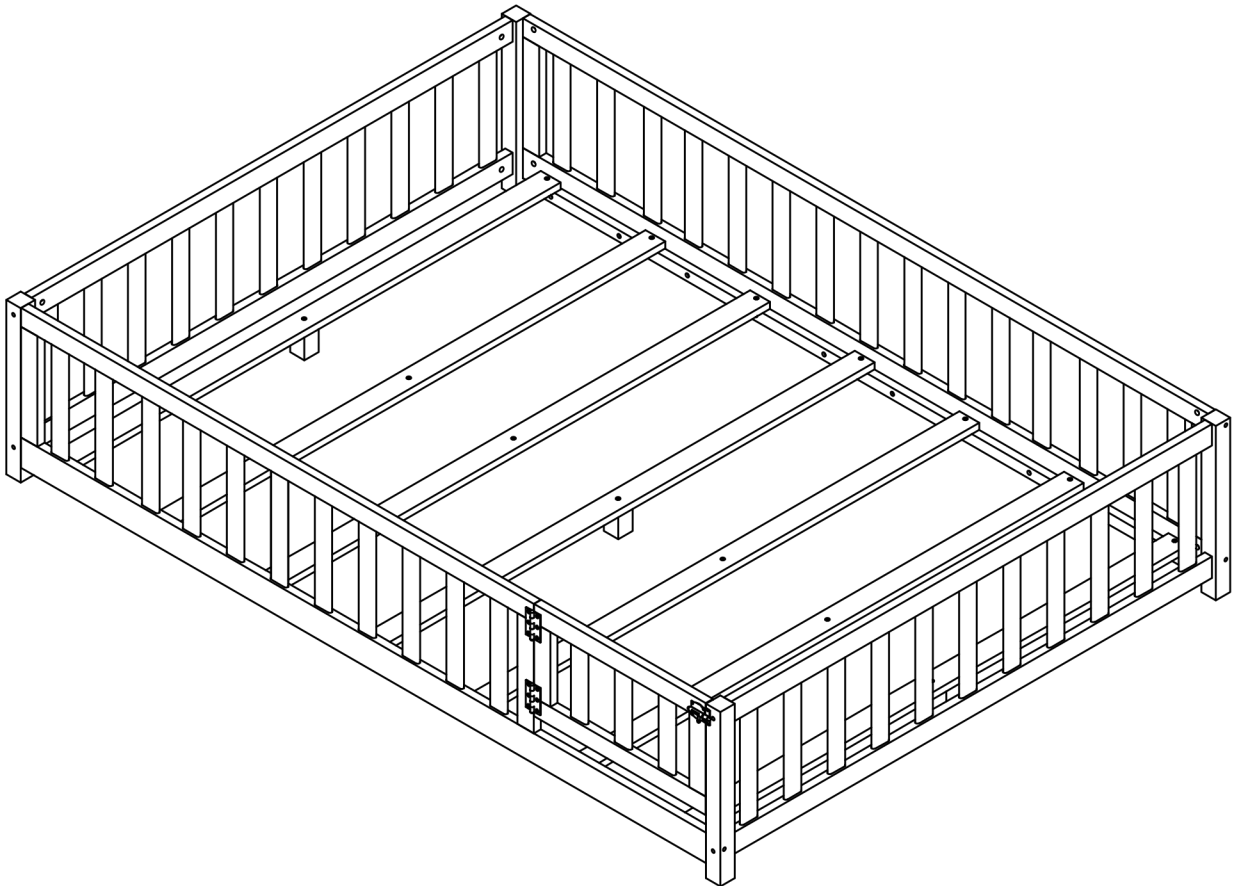

FULL SIZE FLOOR PLATFORM BED

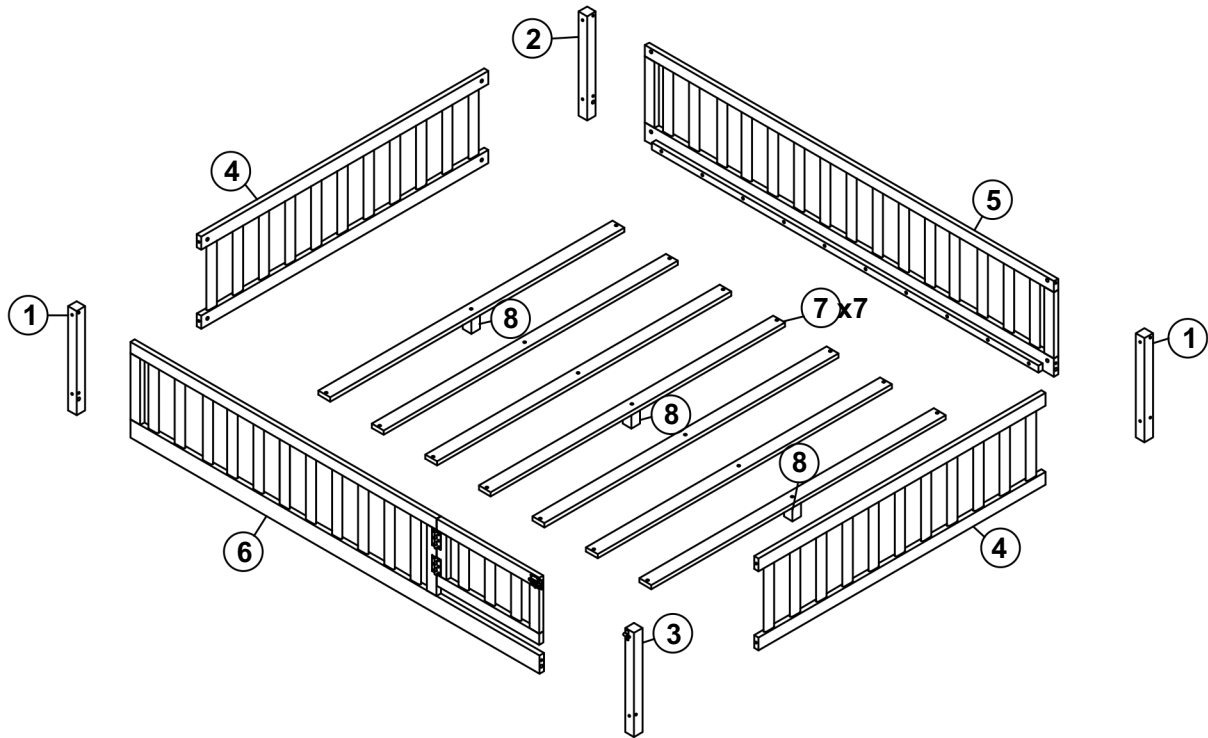



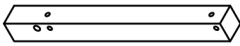
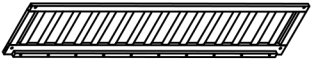
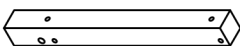
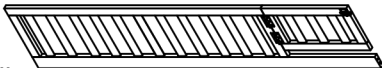
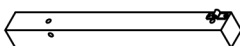
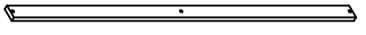
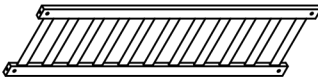

ASSEMBLY INSTRUCTIONS



PARTS LIST

1		2pcs	5		1pc
2		1pc	6		1pc
3		1pc	7		7pcs
4		2pcs	8		3pcs



HARDWARE LIST (

A	1/4x90 	15PCS	D	4x58 	1PC
B	Ø4x30 	17PCS		Phillip head screw Not include 	
C	Ø10x40 	4PCS			

ASSEMBLY INSTRUCTIONS

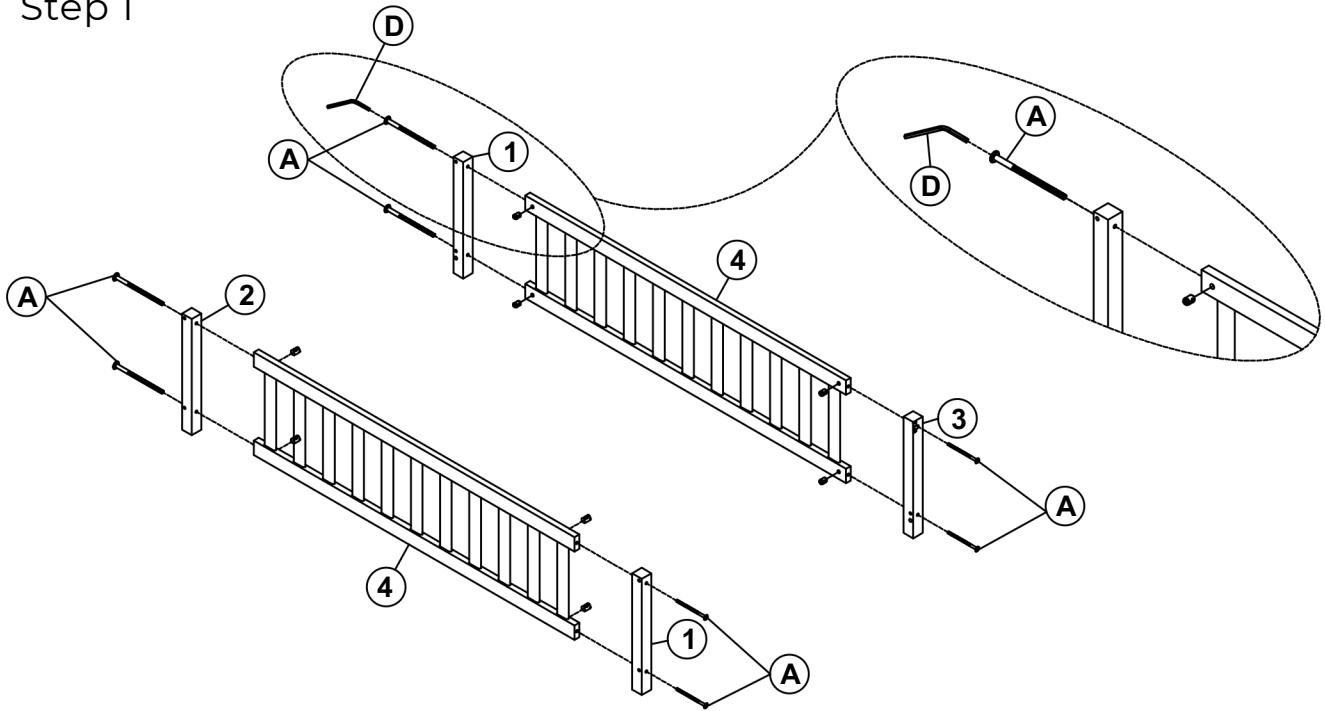

Step 1

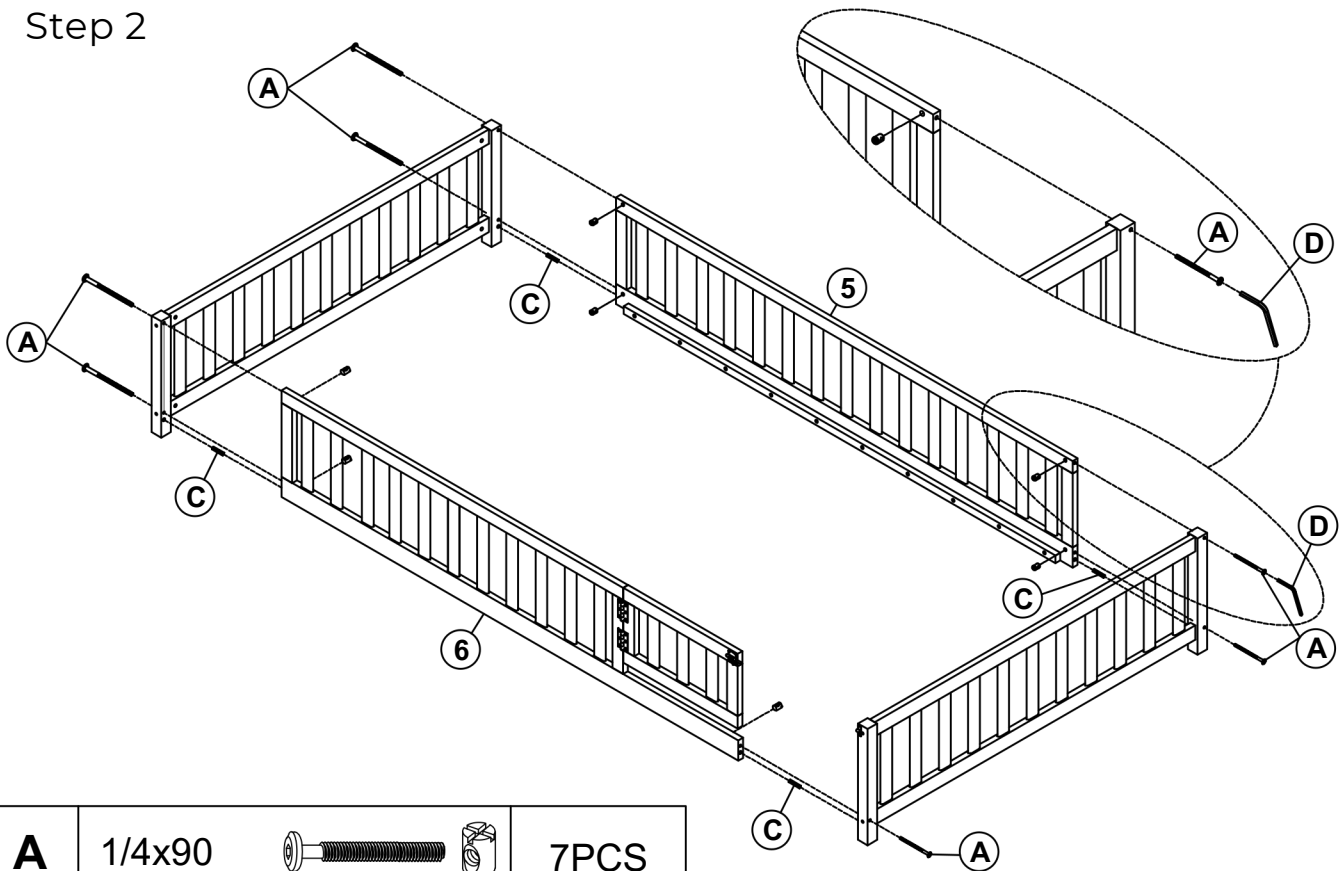

A	1/4x90		8PCS	D	4x58		1PC
----------	--------	---	------	----------	------	--	-----

Step 2

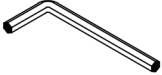

A	1/4x90		7PCS	C	Ø10x40		4PCS	D	4x58		1PC
----------	--------	---	------	----------	--------	---	------	----------	------	---	-----

ASSEMBLY INSTRUCTIONS

Step 3

First attach 2pcs part 7 to the front and end of the frame, between side rails.
Then attach the remaining part 7 equidistantly between side rails.

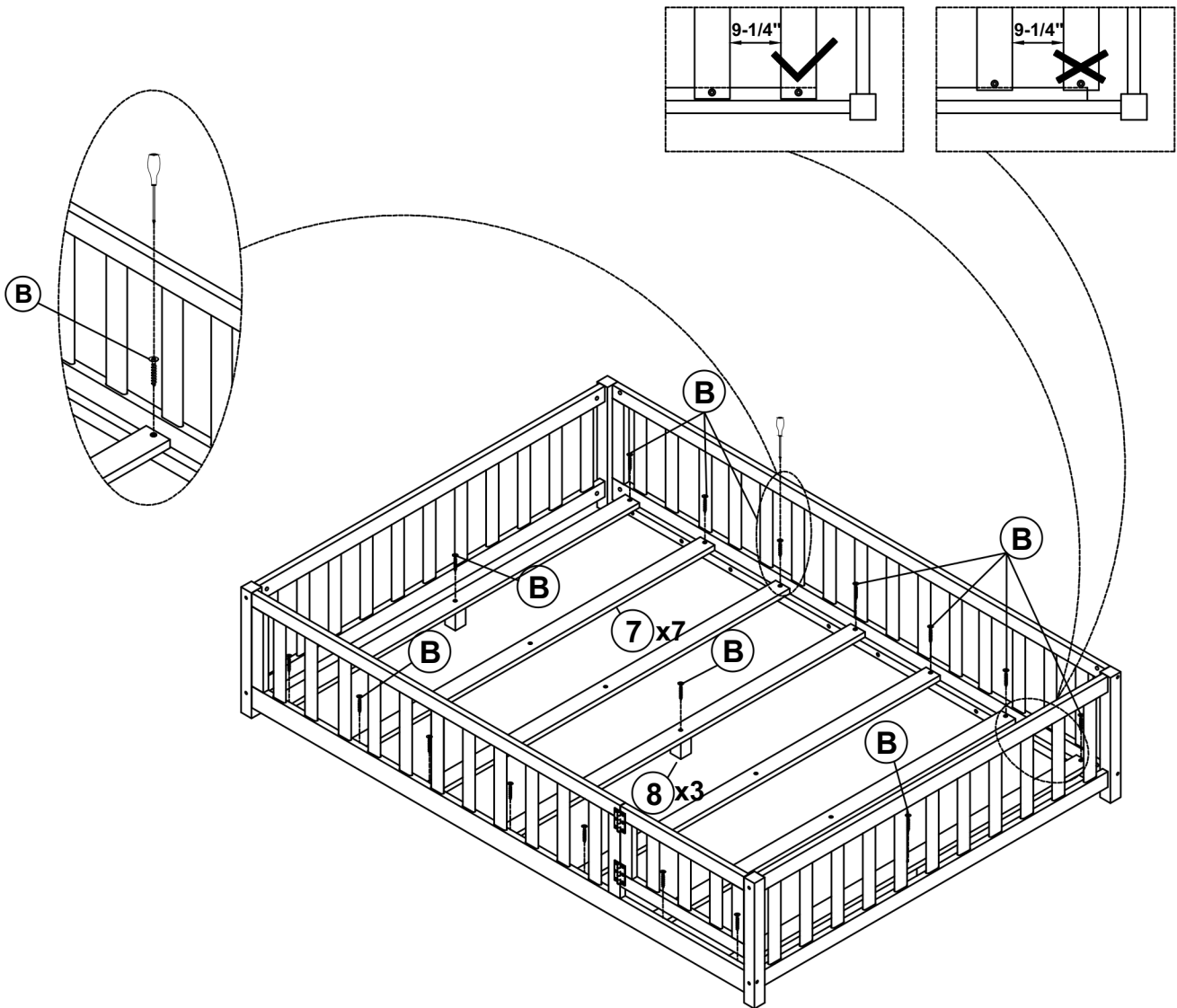

B

Ø4x30



17PCS

ASSEMBLY INSTRUCTIONS

Step 4

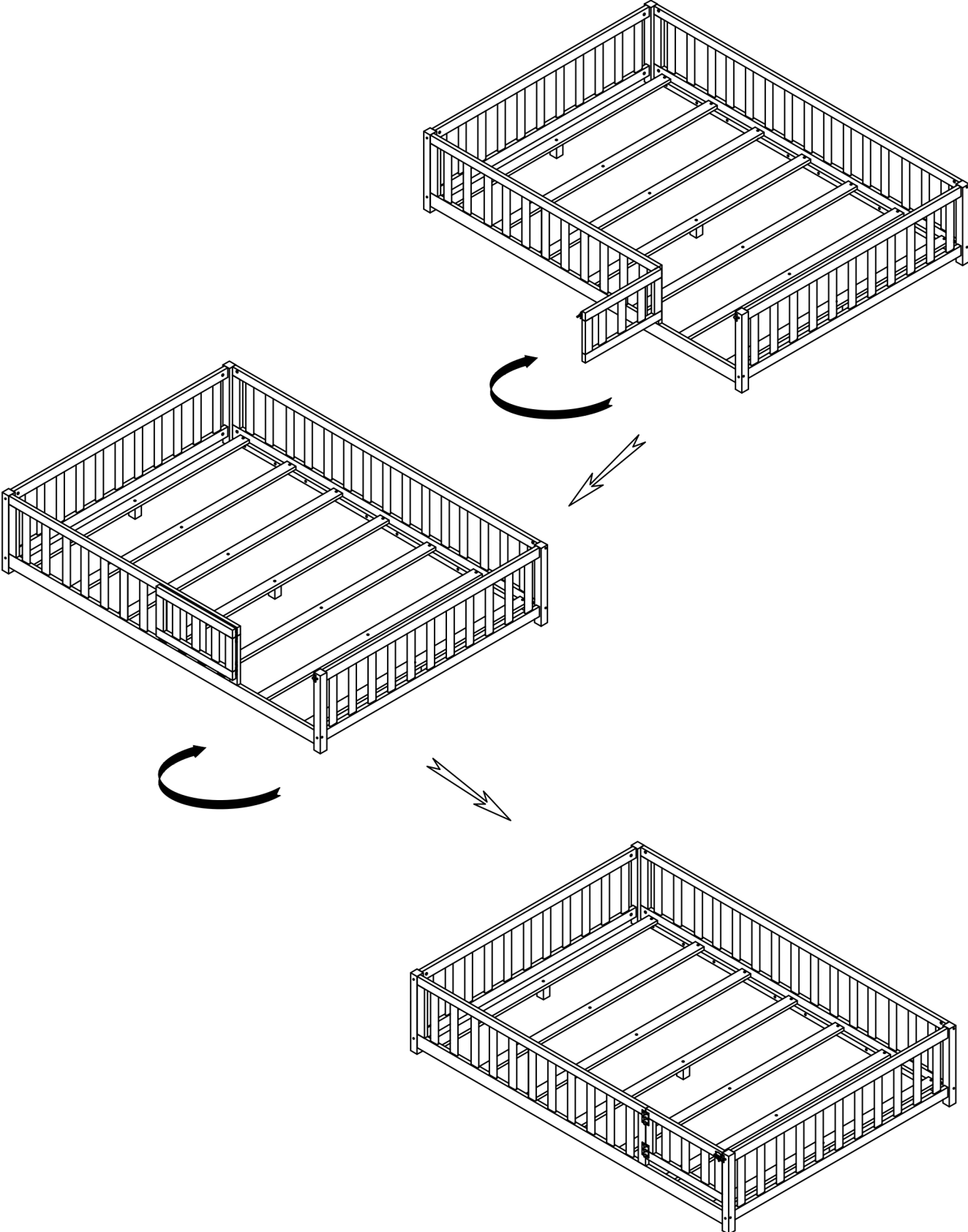

Please note: Make sure to lock all screws.