

C3960 152 ~ 6" Henley Traditional CABINET PULL HANDLE

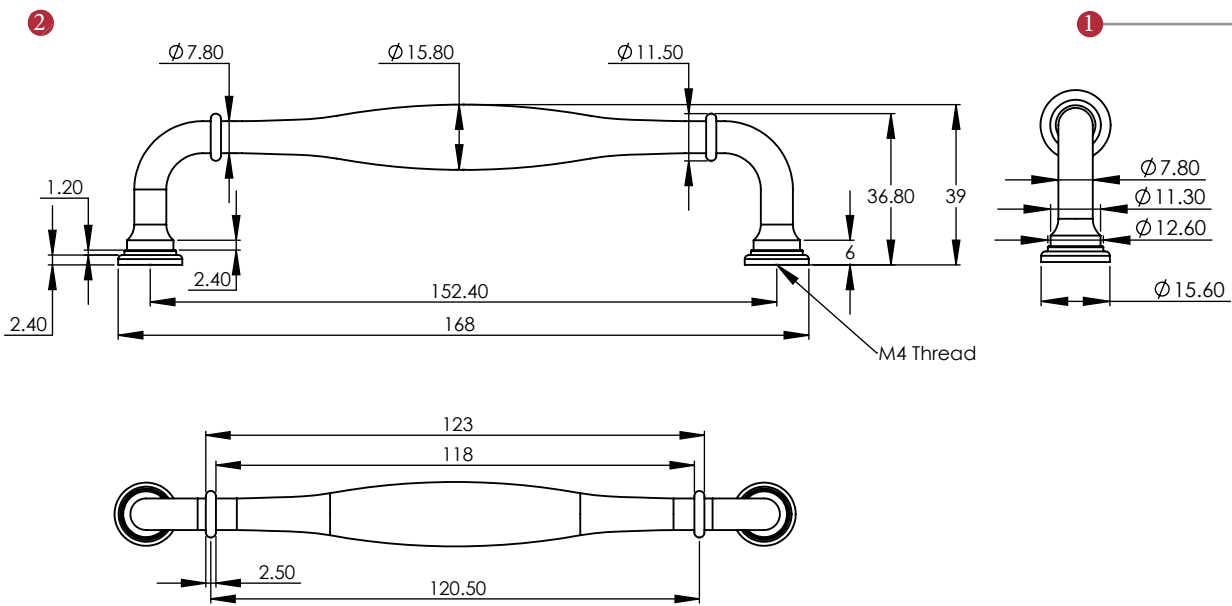

② Dimensions: see the outlines given above



FINISHES

- ME Matt Bronze finish
- SB Satin Brass finish
- PN Polished Nickel finish
- SN Satin Nickel finish
- AT Antique Brass finish
- SC Satin Chrome finish
- PE Polished Brass finish
- PC Polished Chrome finish

Overview

- ① Cabinet Pull illustrated
- ② (General dimensions of Cabinet Pull)
- ③ Supplied with:
2x 30mm Machine Screws
2x 40mm Machine Screws

 M Marcus Ltd., Dudley

Product Code

C3960 152

Material

Solid Brass

Sizes shown are in mm and approximate. We reserve the right to amend where necessary and without any prior notice.