

PARTY TENT

6X18 M
20X60 FT

SKU:E002G075-1 E002G075-6
E002G075-2
E002G075-3
E002G075-4
E002G075-5

ASSEMBLY INSTRUCTIONS

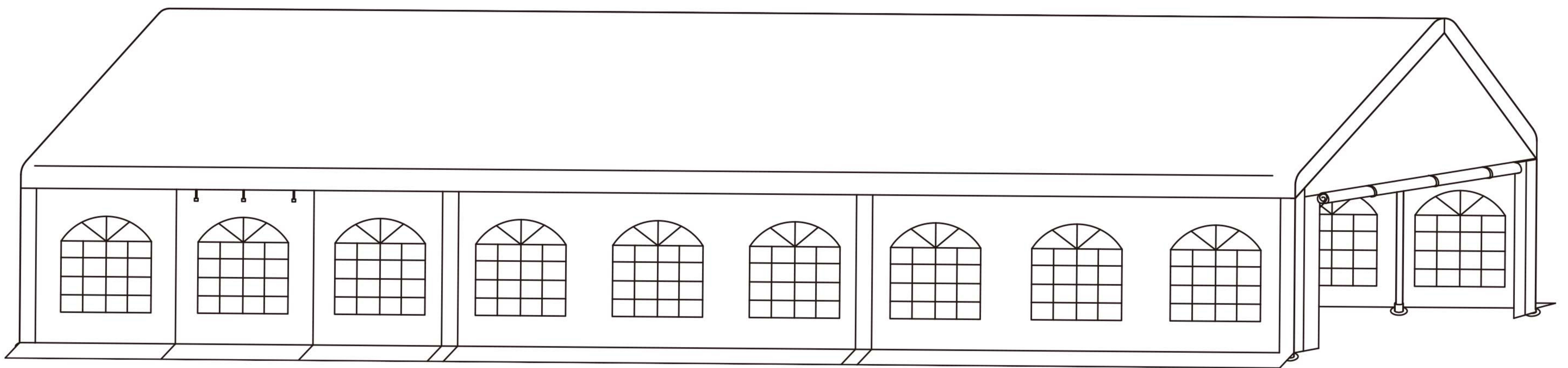

Please check the number of parts in the following accessory catalogue when unpacking. We have sent you more small parts for spare. If there is any missing or any questions about the installation. Please feel free to contact us. We will reply within 24 hours.



E-mail: cs.helper01@gmail.com

TOOLS RECOMMENDED

*NOTE: The recommended tools are not included in boxes and need to be prepared by yourself.

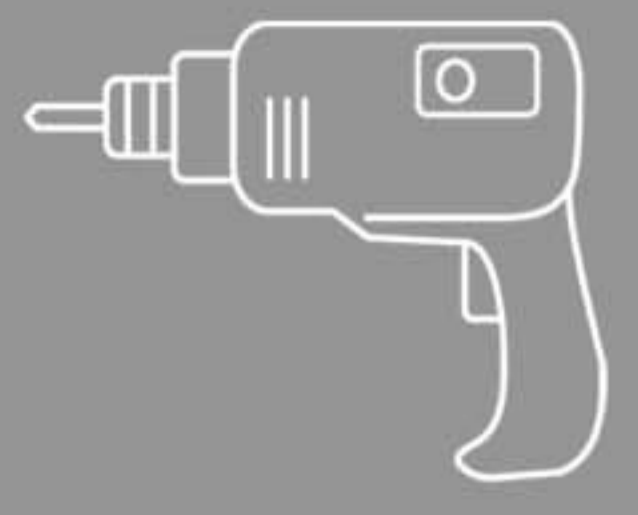

DRILL



RUBBER Mallet



STEPLADDER
(6.5Ft Or More)



SAFETY HAT



GLOVES

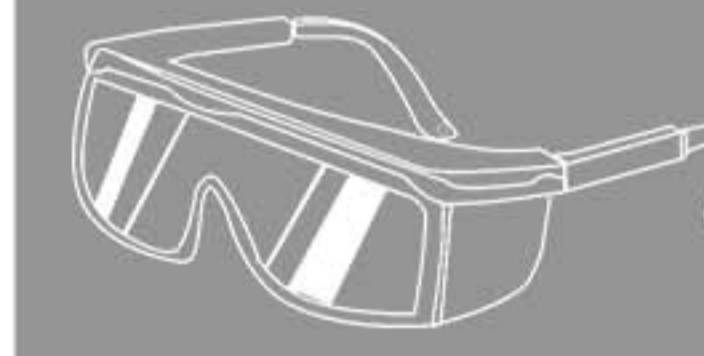

SAFETY GOGGLES

ATTENTIONS



Since it is easy to lose many small accessories during the installation, please collect all the screw accessories before the assembly is completed



To better align the screws for practical situations, do not fully tighten screws initially



Please reinforced the Gazebo and do not use in heavy winds or inclement weather



Make sure all screws are tightened before use and check all screws, buckles and straps every 90 days

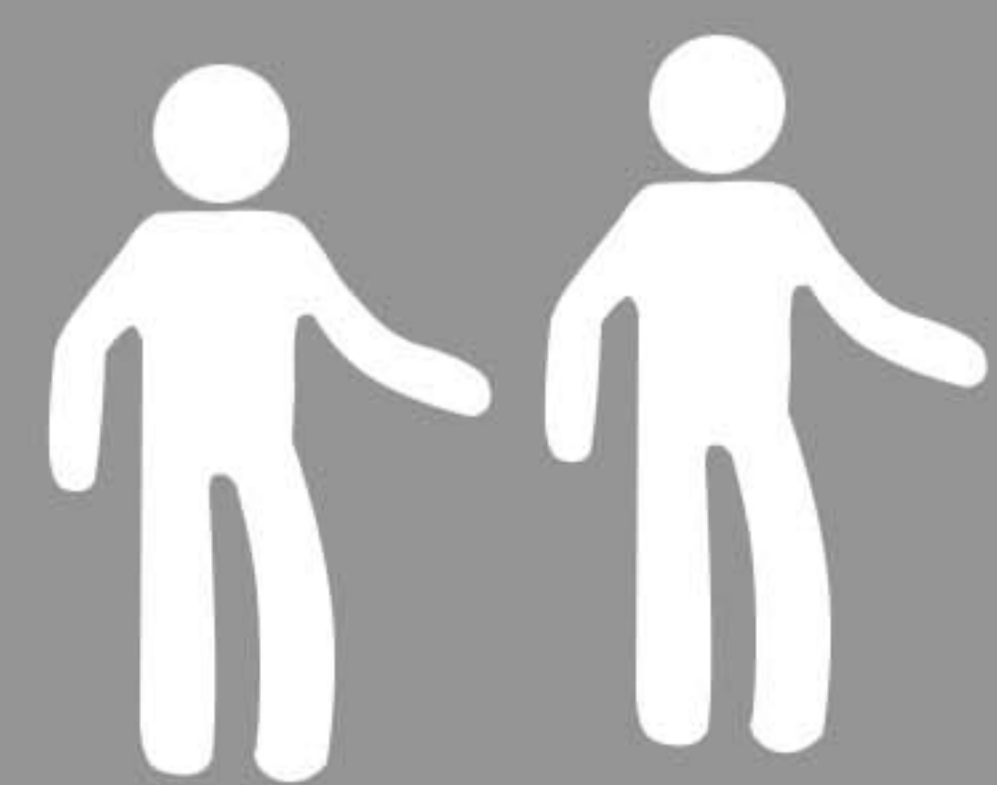

Two or more people are required for assembly



Please clear the snow off the roof in time for the heavy snowfall and do not use it

Please take care of the screws and contact the after-sales service if there is any problem with the installation or parts.



ACCESSORY CATALOGUE

BOX 1

SKU:E002G075-1

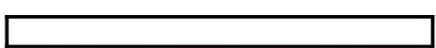
Item no.	Reference Image	Qty.
1		40

BOX 2

SKU:E002G075-2

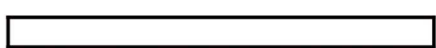
Item no.	Reference Image	Qty.
2		27

BOX 3

SKU:E002G075-3

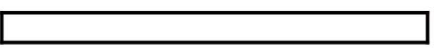
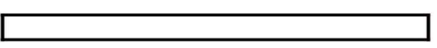
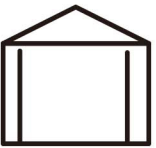
Item no.	Reference Image	Qty.	Item no.	Reference Image	Qty.
3		10	7		24
E		2			





Please take care of the screws and contact the after-sales service if there is any problem with the installation or parts.

➔  E-mail: cs.helper01@gmail.com

ACCESSORY CATALOGUE





BOX 4

SKU:E002G075-4

Item no.	Reference Image	Qty.	Item no.	Reference Image	Qty.
3		10	6		10
4		18	8		4
5		20			

BOX 5

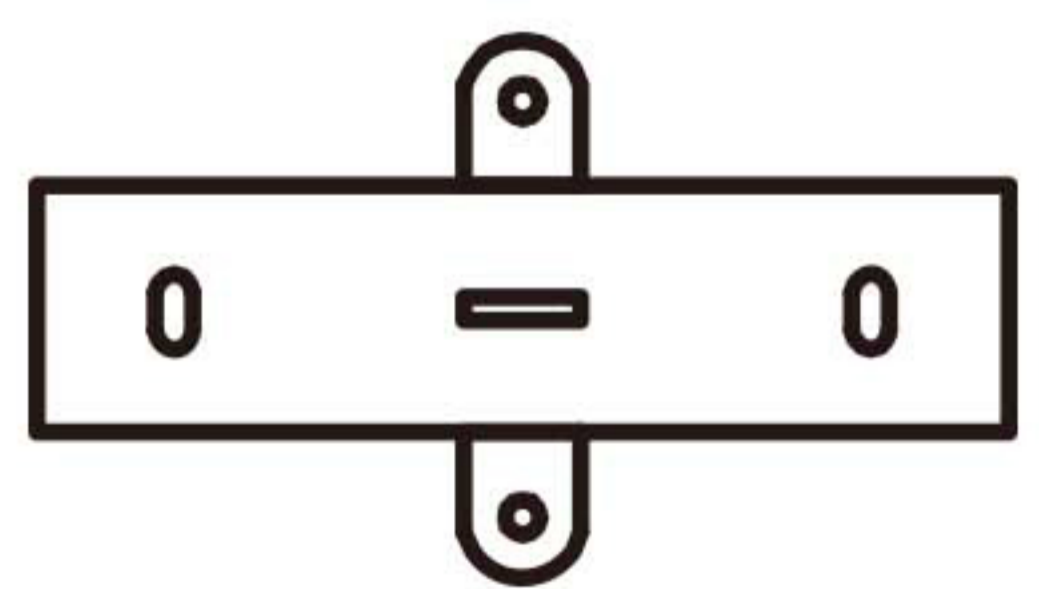

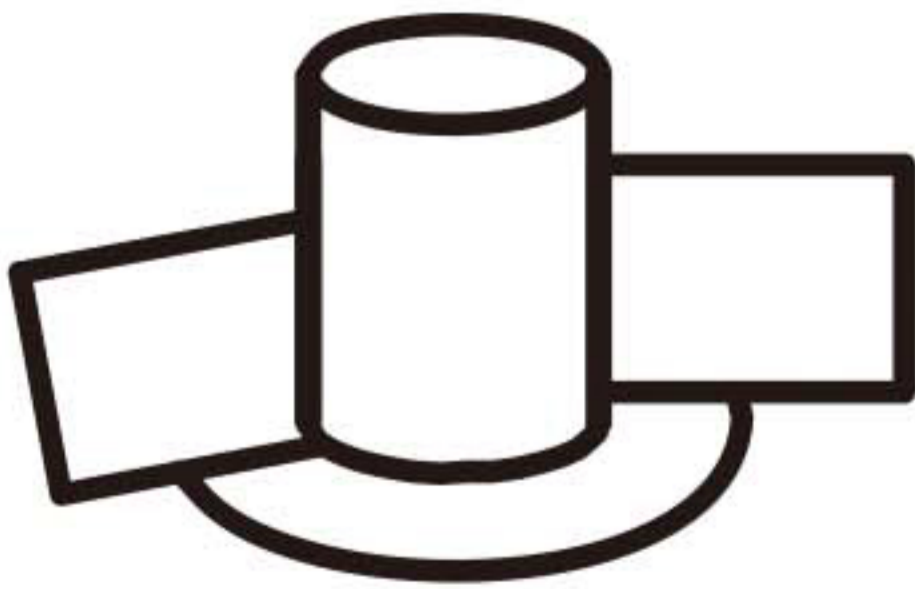
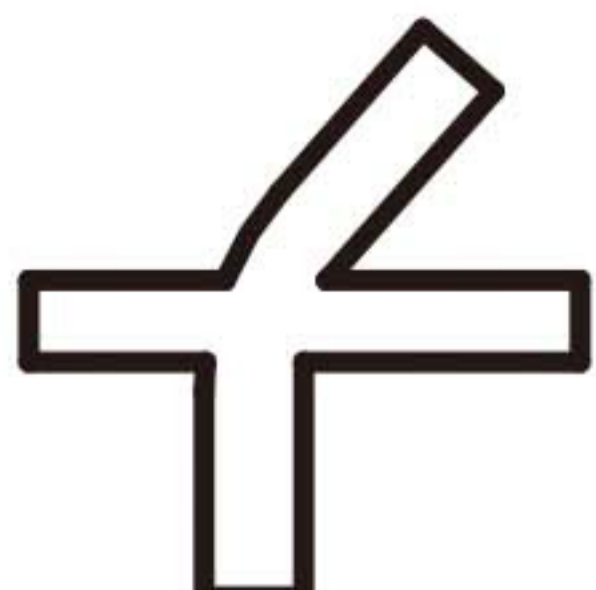
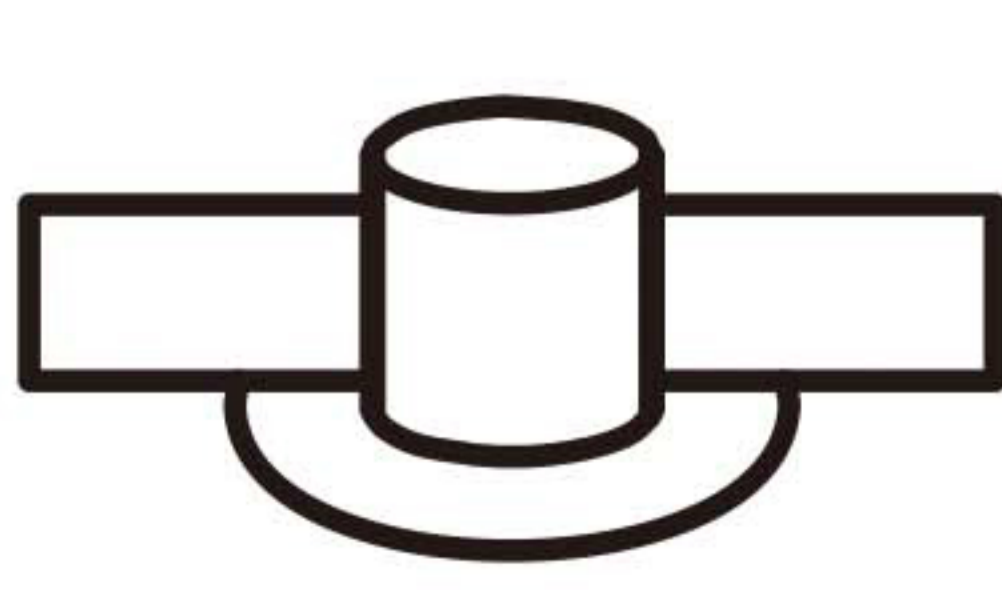





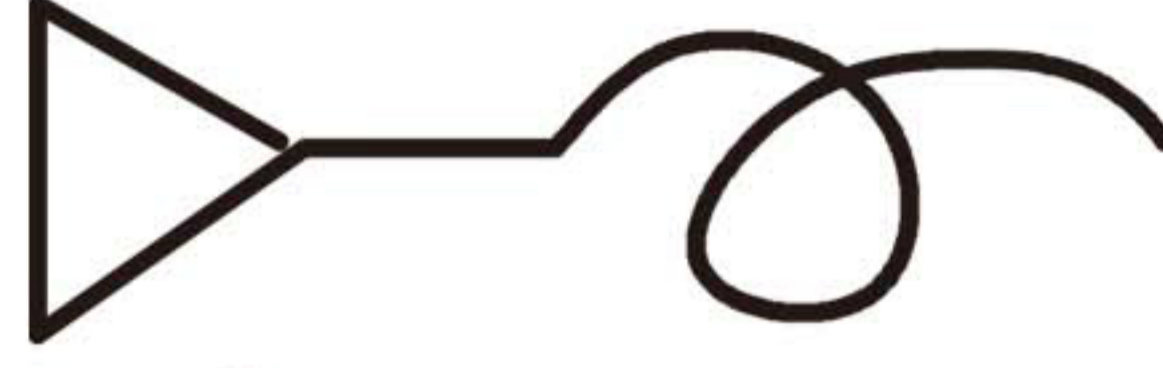

SKU:E002G075-5

Item no.	Reference Image	Qty.	Item no.	Reference Image	Qty.
A		2	C1		2
A1		4	D		16
B		8	F		4
B1		16	F2		16

Please take care of the screws and contact the after-sales service if there is any problem with the installation or parts.



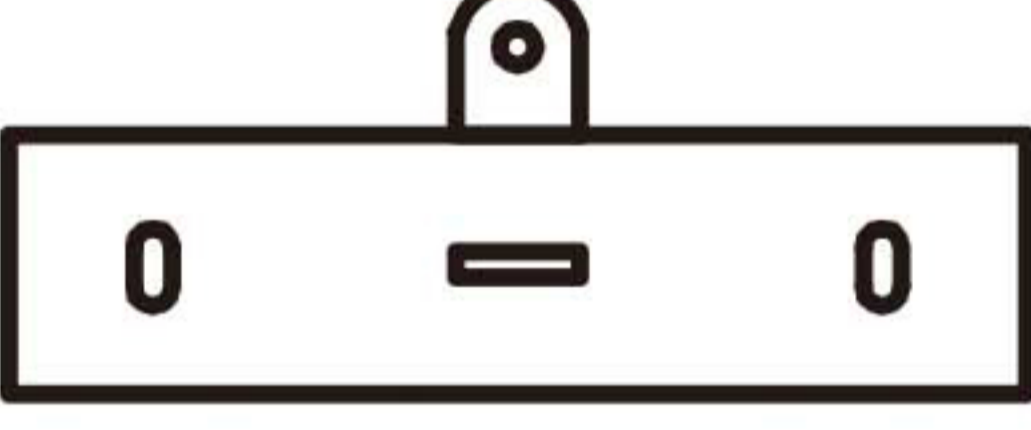

ACCESSORY CATALOGUE

Item no.	Reference Image	Qty.	Item no.	Reference Image	Qty.
H		4	M	 M8x50mm	40
I		8	N	 φ4	38
J	 M6x25mm	8	O	 φ 5x250mm	4
K	 M6x16mm	76			2
L	 M8x50mm	20	G		276
C		2	10		4

BOX 6

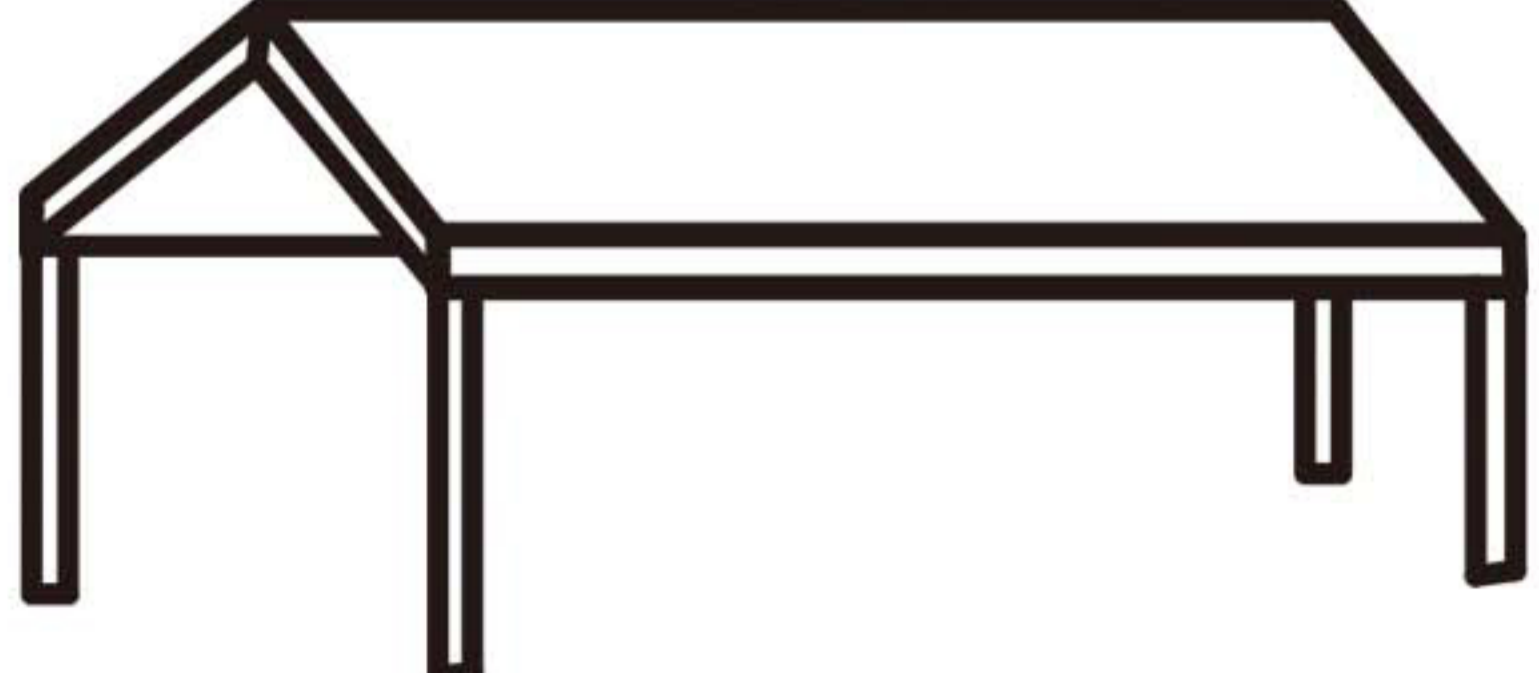
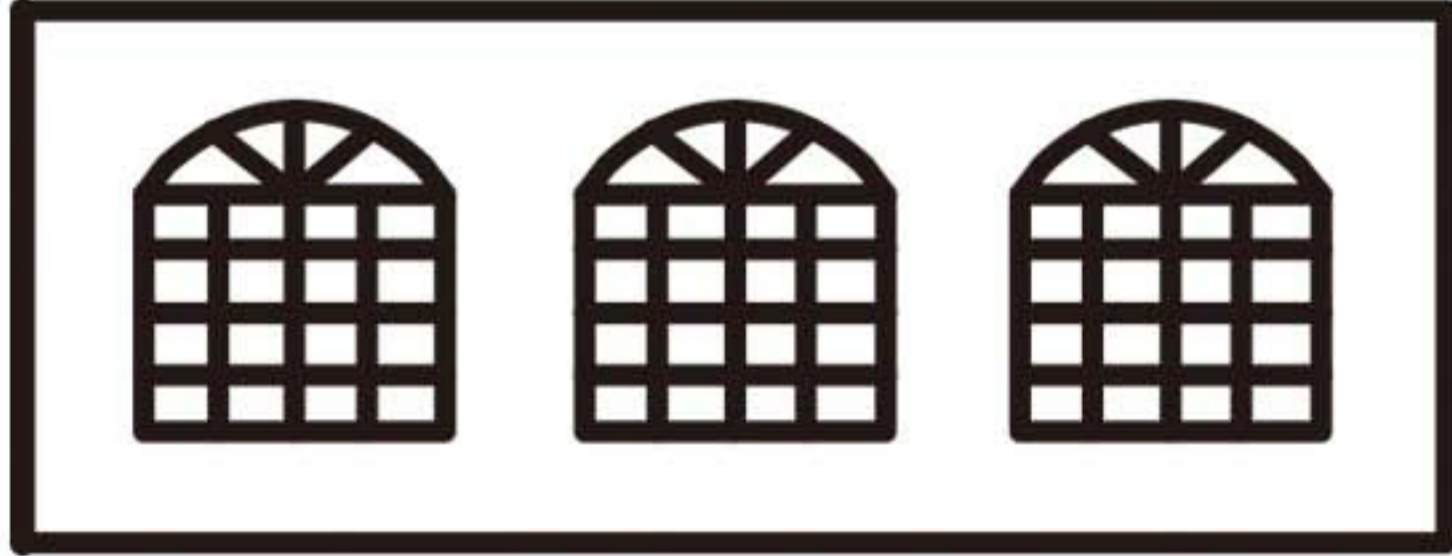
SKU:E002G075-6

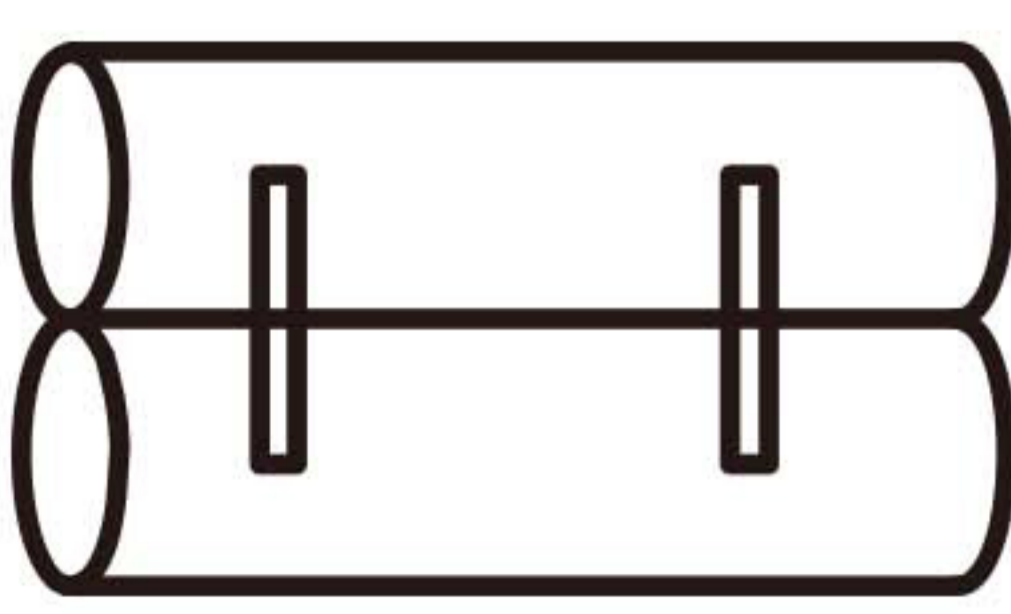
Item no.	Reference Image	Qty.	Item no.	Reference Image	Qty.
P		1	Q1		4
Q		2			4

Please take care of the screws and contact the after-sales service if there is any problem with the installation or parts.

➔ ✉ E-mail: cs.helper01@gmail.com

Reference image











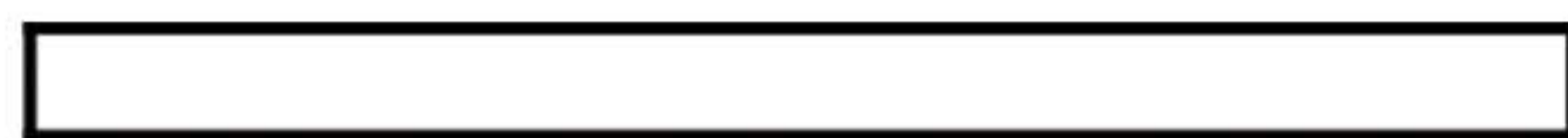

Please take care of the screws and contact the after-sales service if there is any problem with the installation or parts.

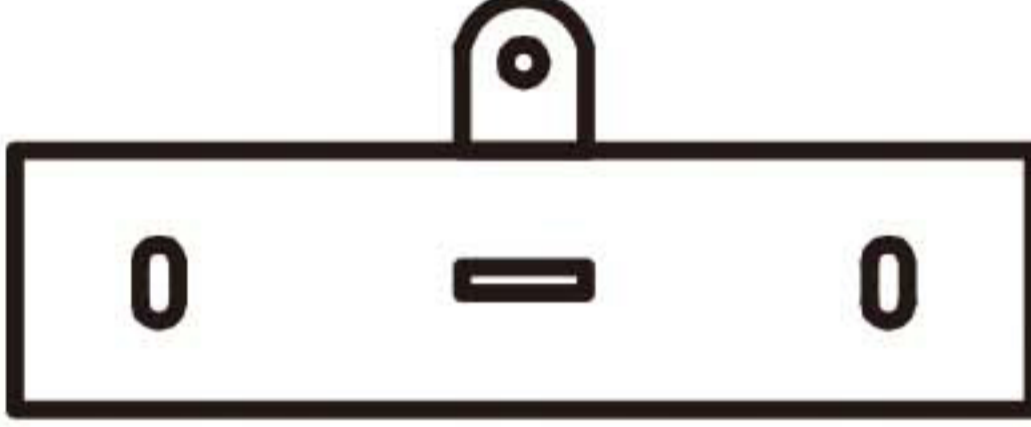

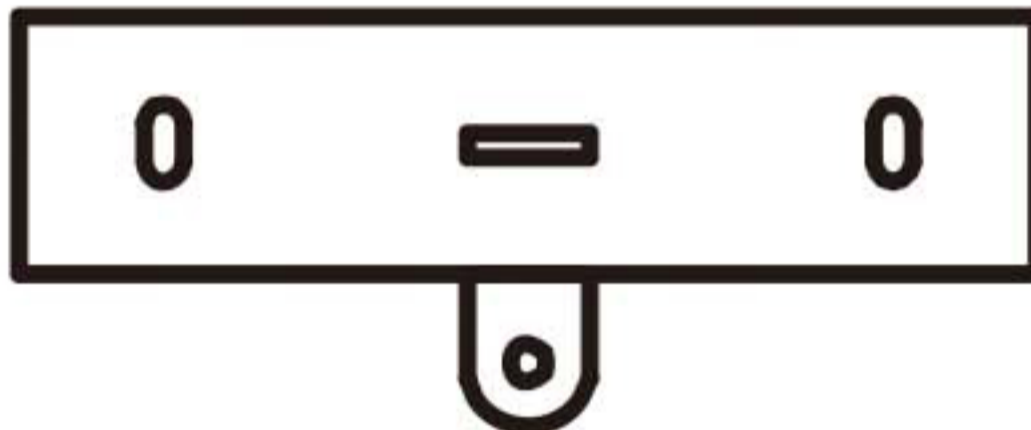
STEP 1

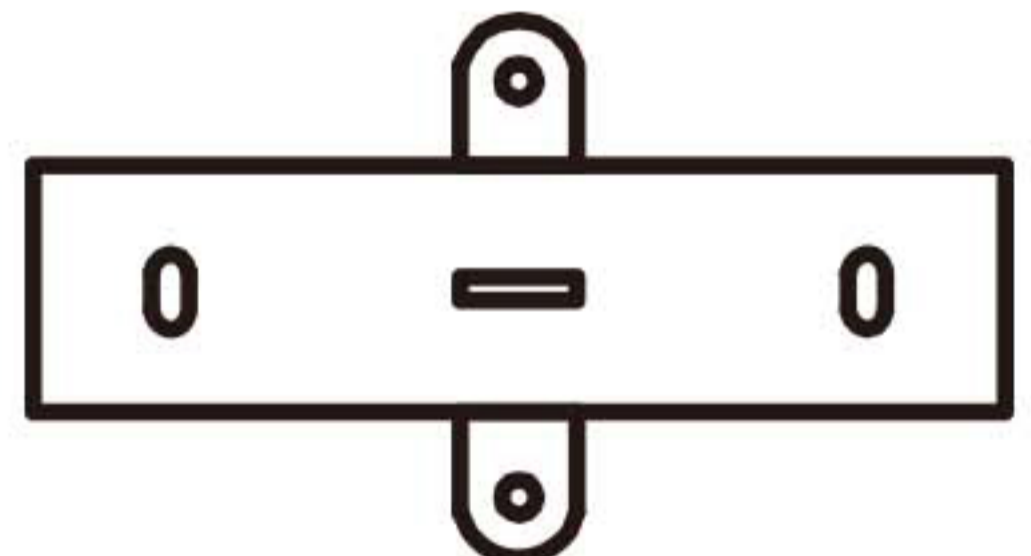
Parts required

	1 40pcs		B 8pcs
	2 27pcs		B1 16pcs
	4 18pcs		C 2pcs
	1 4pcs		C1 2pcs
	A 2pcs		D 16pcs
	A1 4pcs		

Please take care of the screws and contact the after-sales service if there is any problem with the installation or parts.

➔  E-mail: cs.helper01@gmail.com

For convenience, please place each accessory according to the position shown in the figure, and then start to build.

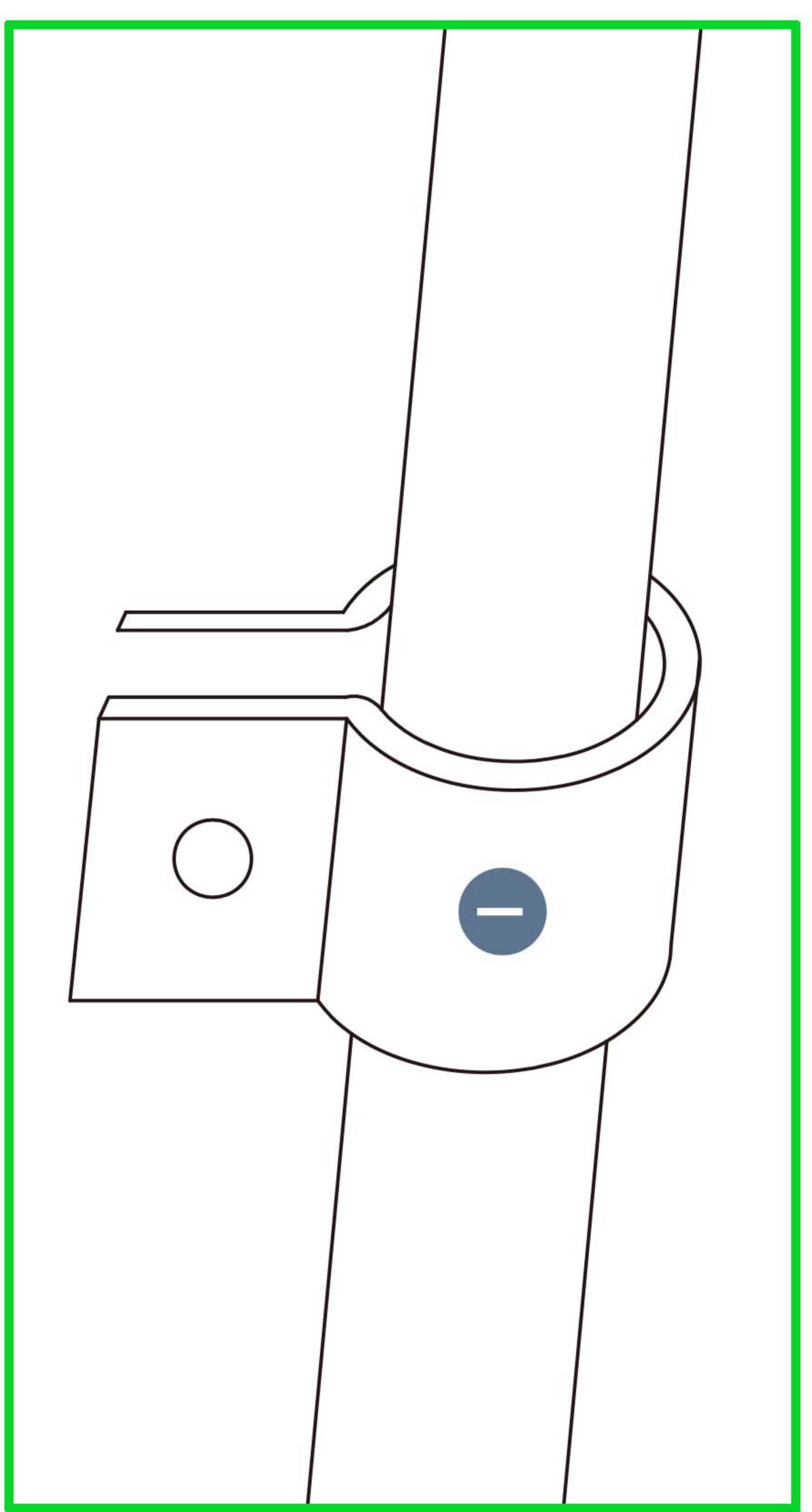


Please take care of the screws and contact the after-sales service if there is any problem with the installation or parts.

STEP2

Parts required



M8x50mm

M 40pcs

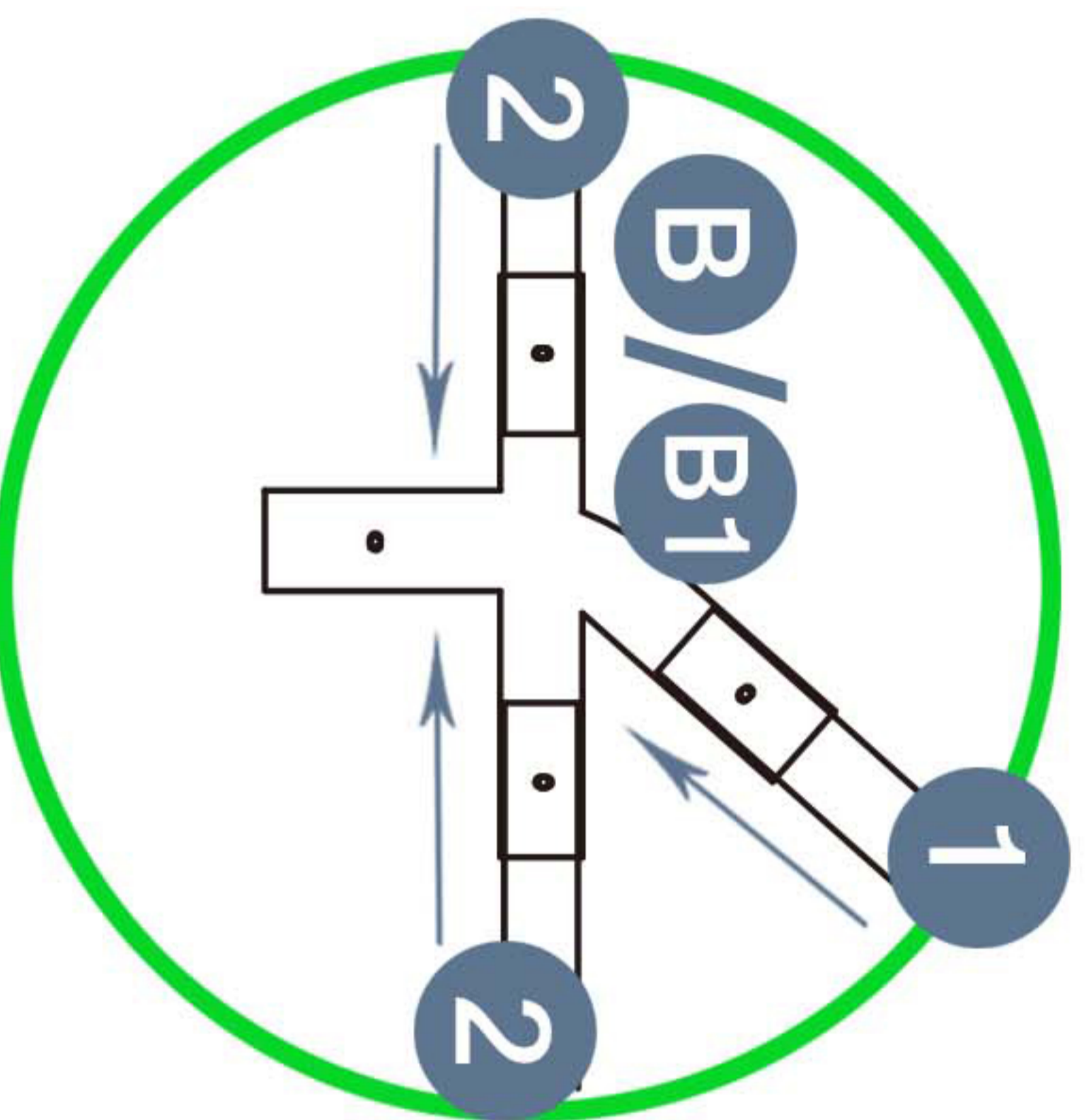
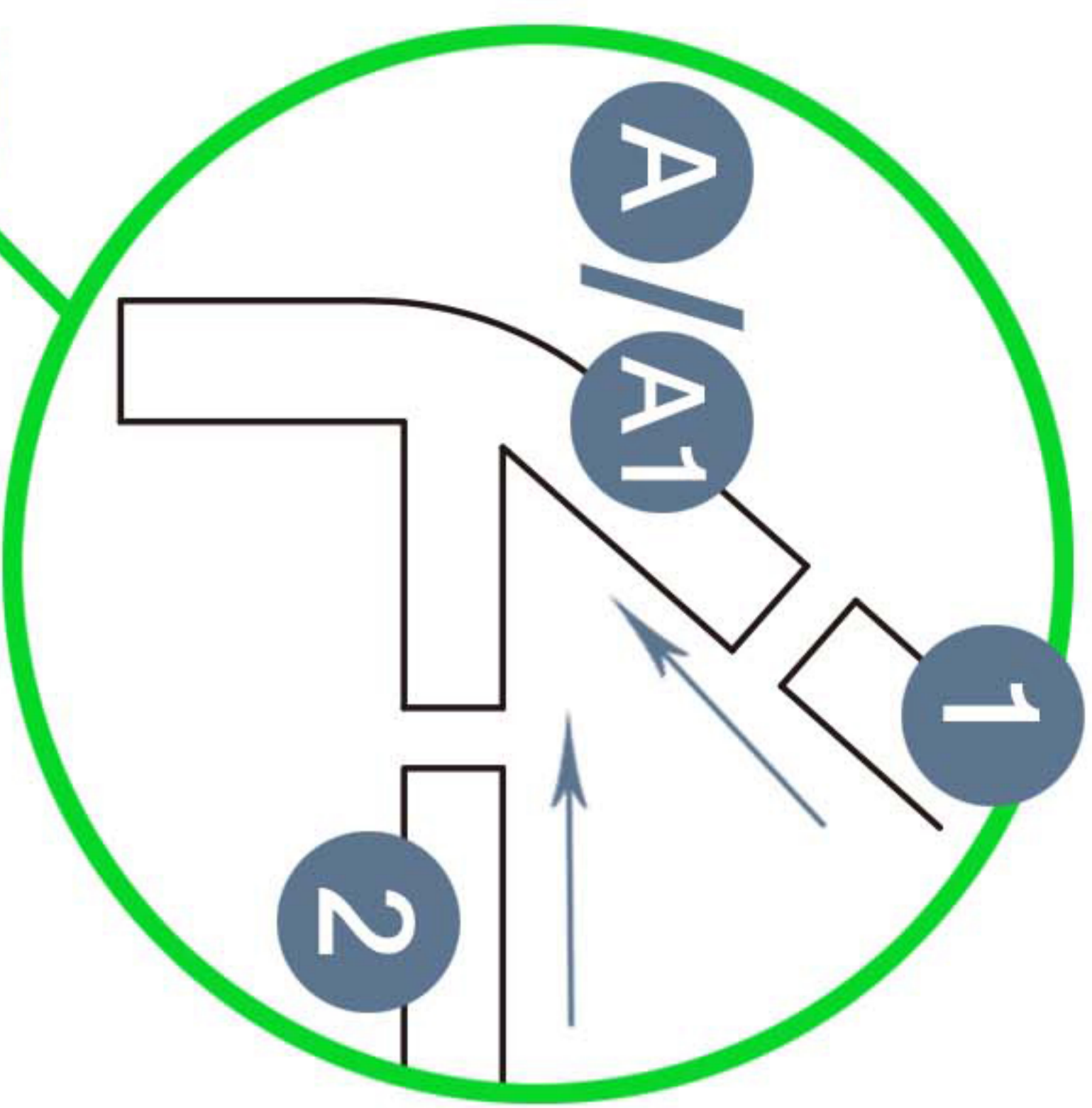

A/A1/B/B1 are directly connected.
C/C1/D need to be connected with screws.



Please take care of the screws and contact the after-sales service if there is any problem with the installation or parts.

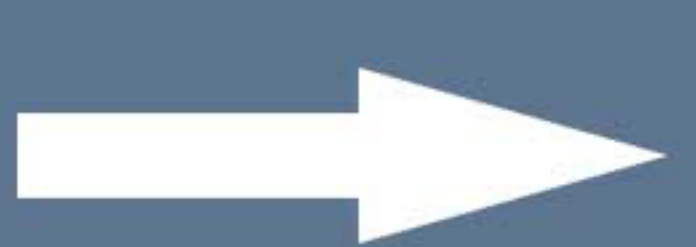

E-mail: cs.helper01@gmail.com

STEP 3

Parts required

 M6x16mm
 **K** 36pcs







Please take care of the screws and contact the after-sales service if there is any problem with the installation or parts.



STEP 4

Parts required

-  **5** 20pcs
-  **6** 10pcs
-  **K** 40pcs
-  M6x16mm

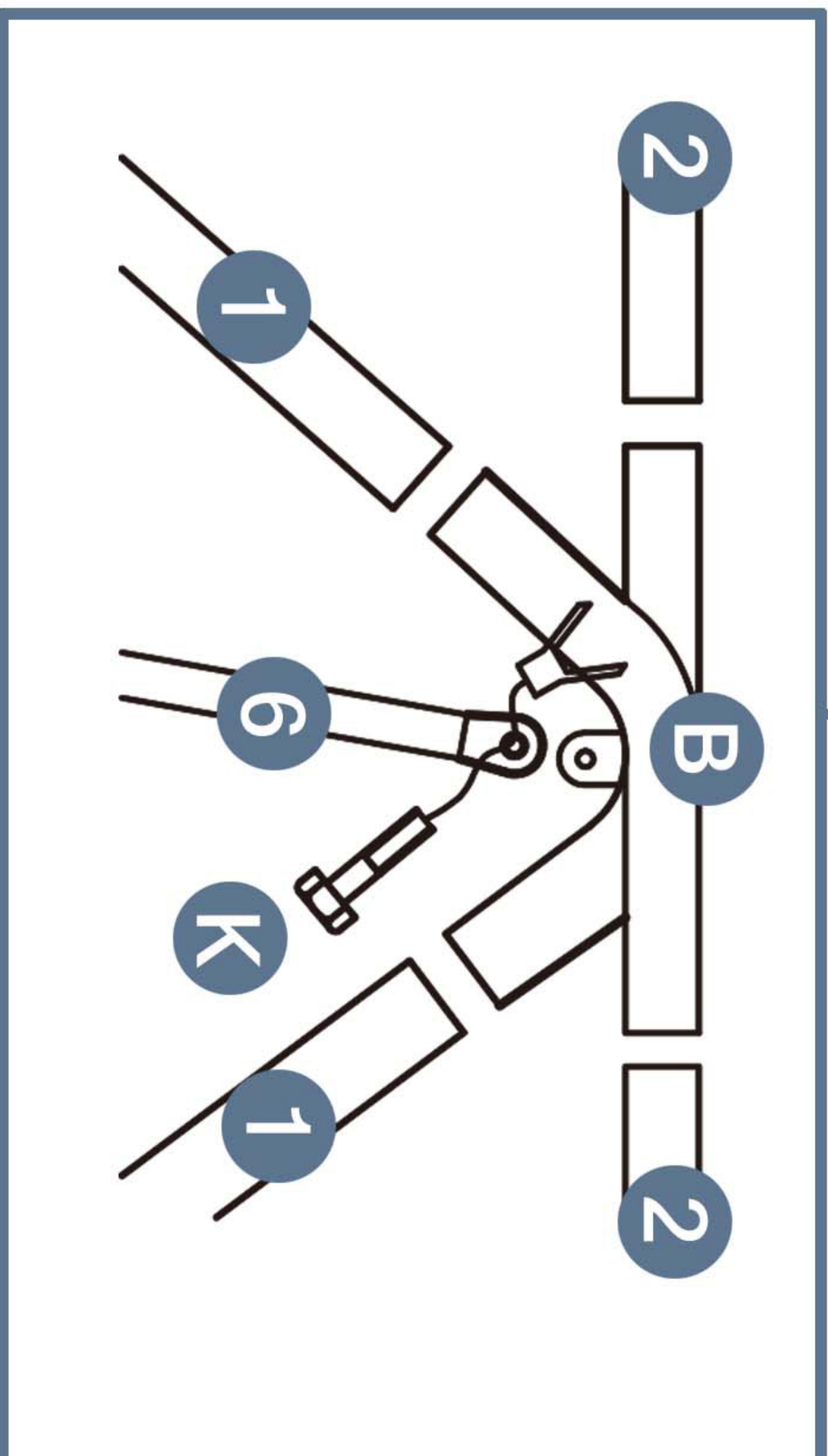
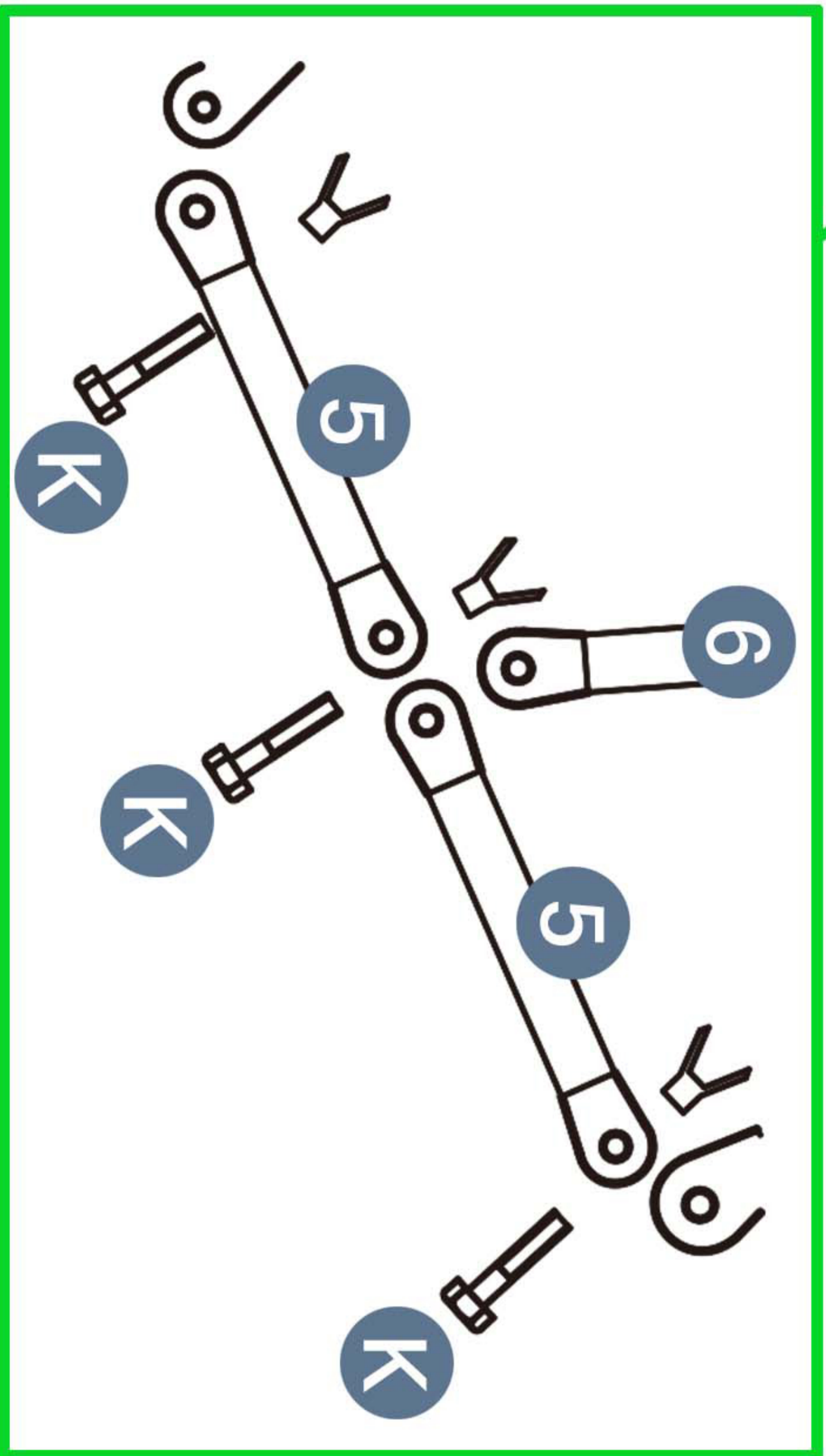

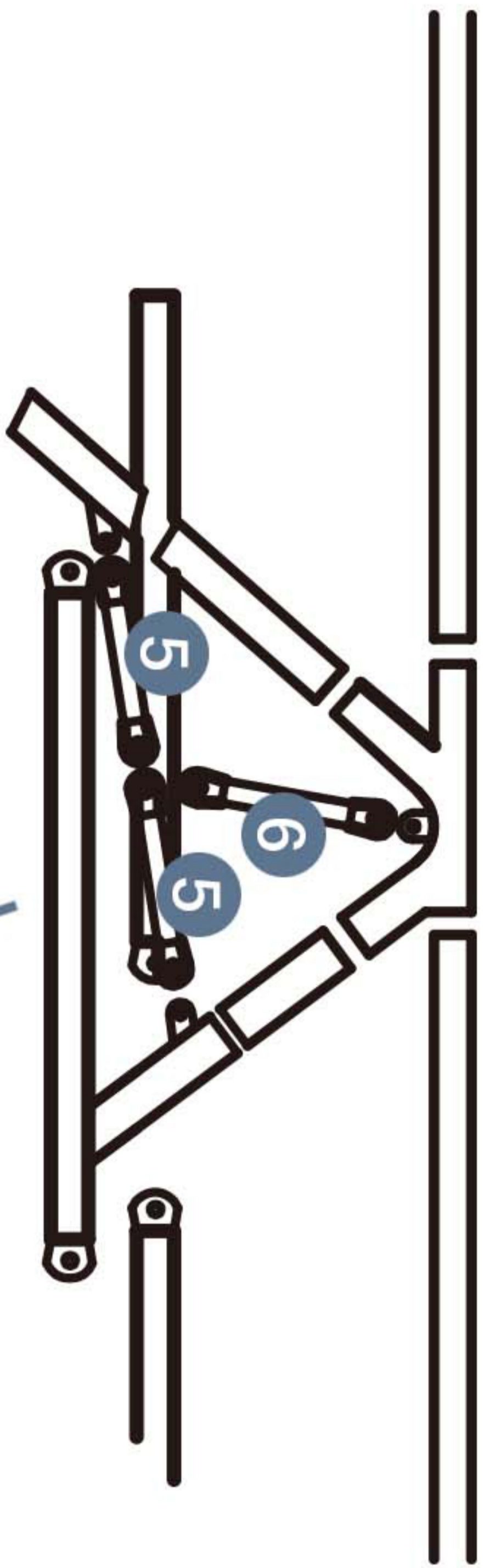

Please take care of the screws and contact the after-sales service if there is any problem with the installation or parts.

➔  E-mail: cs.helper01@gmail.com

STEPS

Parts required

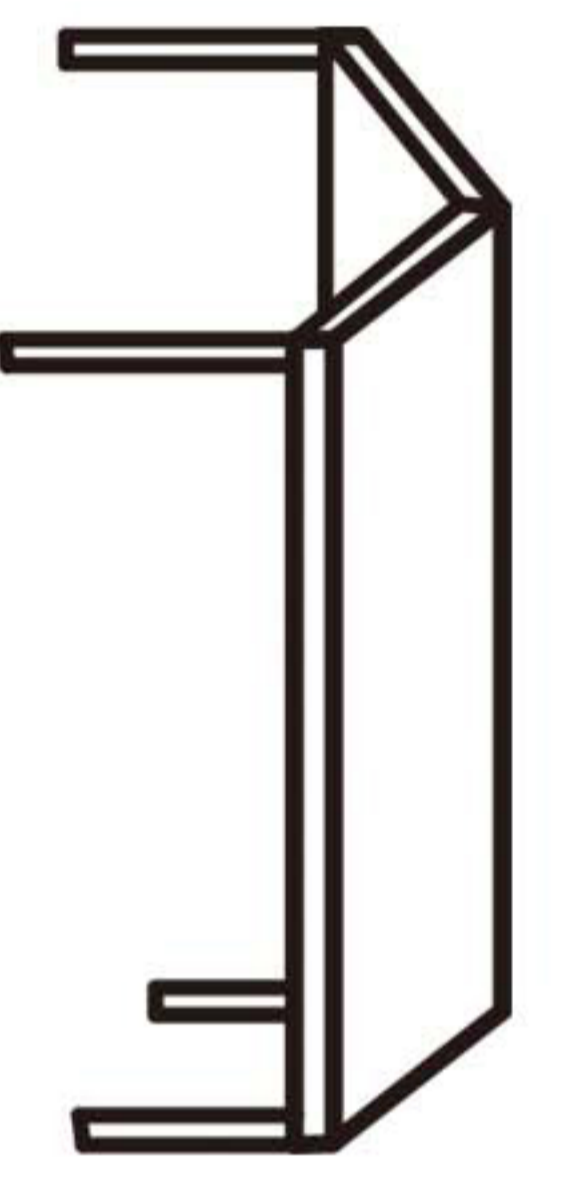

P 1pcs



Please take care of the screws and contact the after-sales service if there is any problem with the installation or parts.



E-mail: cs.helper01@gmail.com

STEP 6

Parts required



3 10pcs

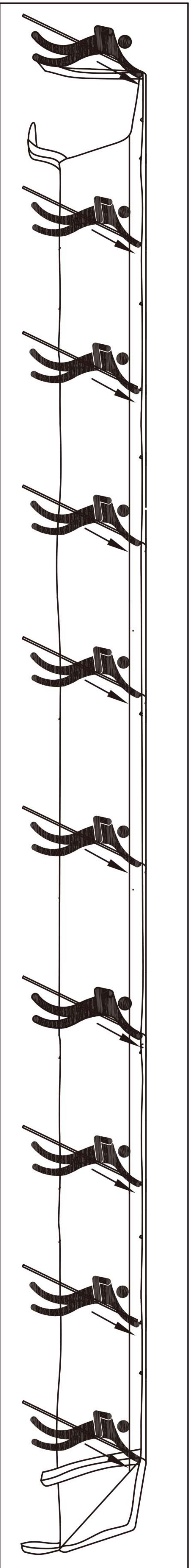


Please take care of the screws and contact the after-sales service if there is any problem with the installation or parts.

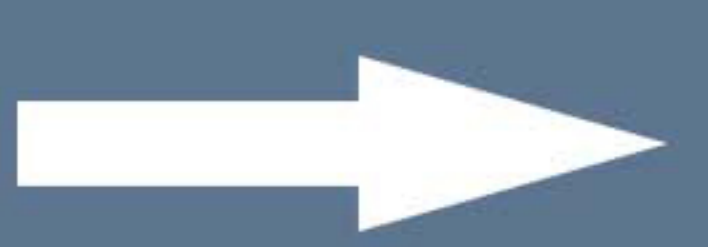

E-mail: cs.helper01@gmail.com

STEP 7

Parts required

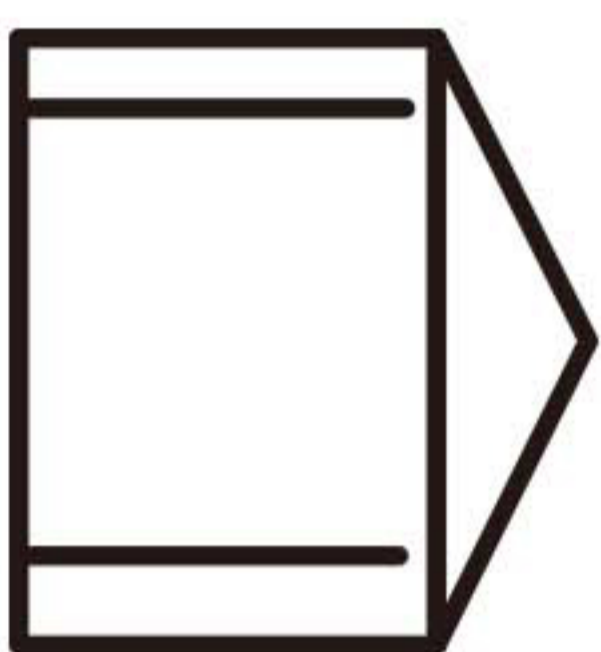

E 2pcs



G 36pcs



Please take care of the screws and contact the after-sales service if there is any problem with the installation or parts.

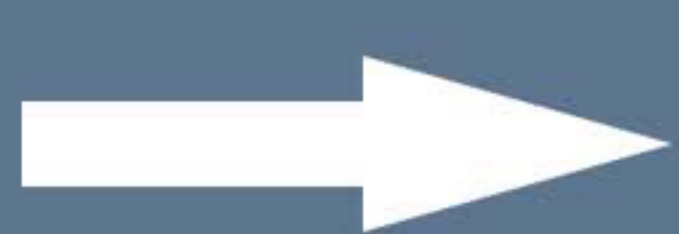

E-mail: cs.helper01@gmail.com

STEP 8

Parts required



3 10pcs







Please take care of the screws and contact the after-sales service if there is any problem with the installation or parts.

➔ ✉ E-mail: cs.helper01@gmail.com

STEP 9

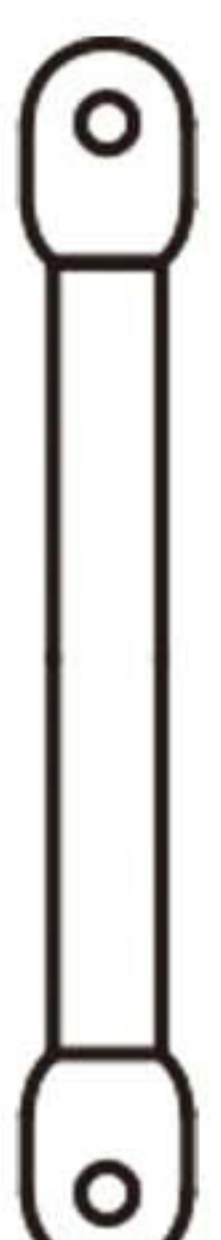
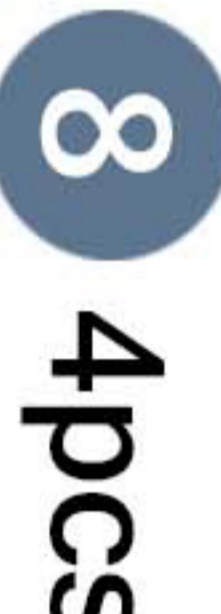
Parts required

-  **1** 4pcs
-  **J** 8pcs
-  **3** 4pcs
-  **8** 4pcs
-  M6x25mm

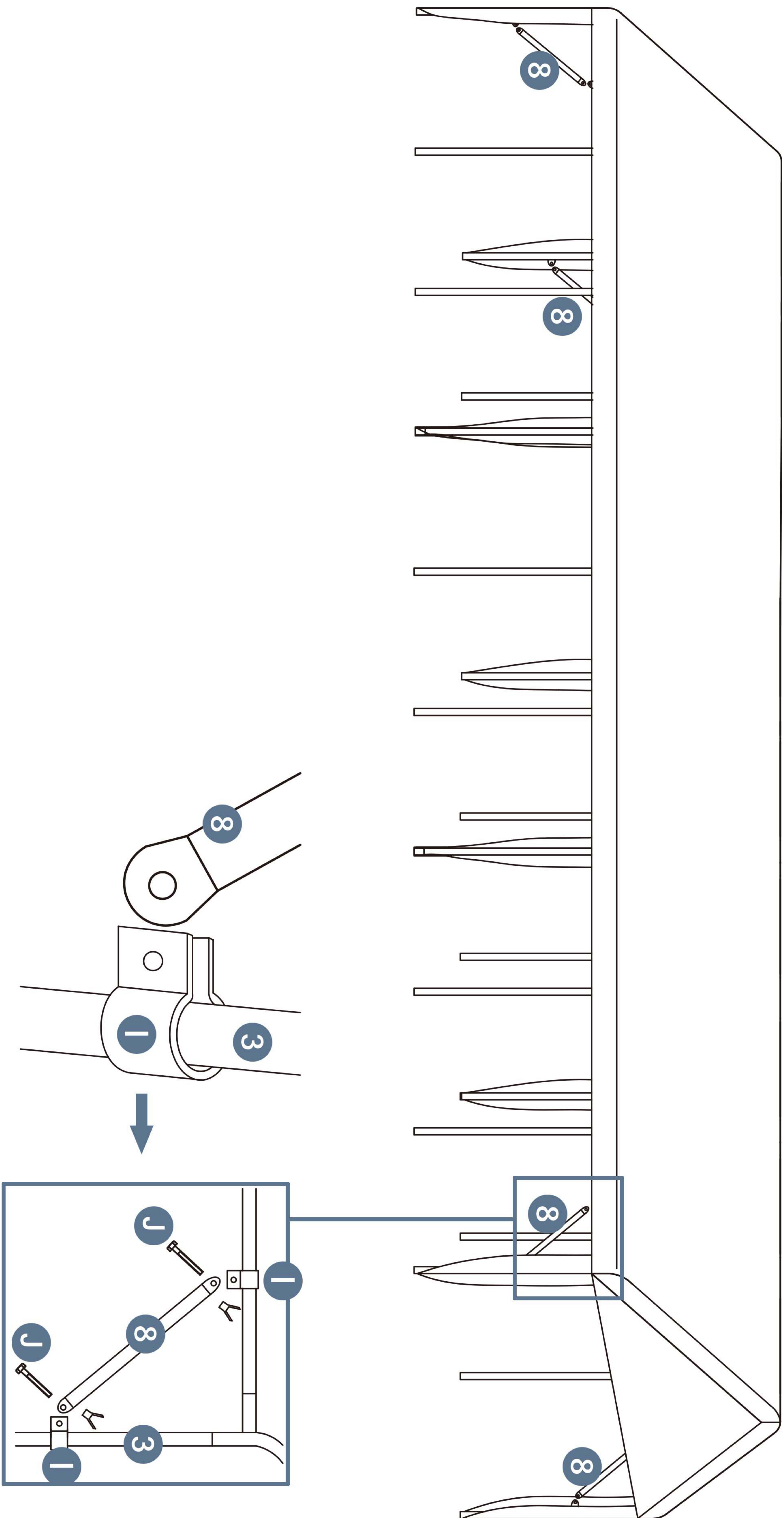



Please take care of the screws and contact the after-sales service if there is any problem with the installation or parts.

➔ ✉ E-mail: cs.helper01@gmail.com

STEP 10

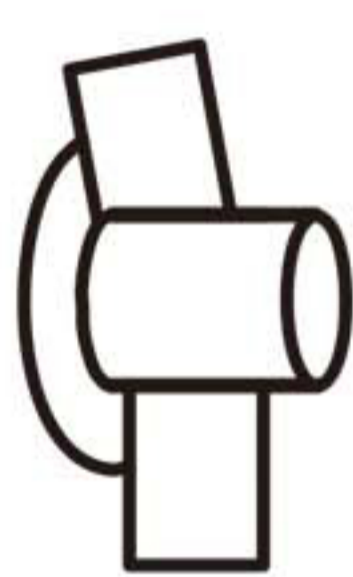
Parts required

-  **7** 24pcs
-  **F** 4pcs
-  **F2** 16pcs
-  **10** 4pcs



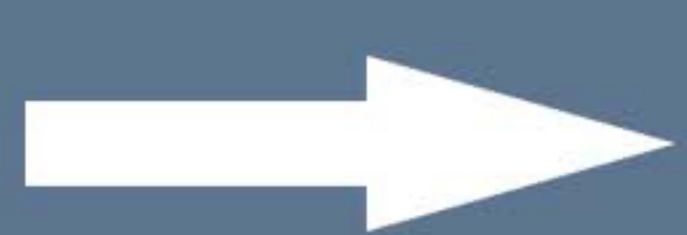

Please take care of the screws and contact the after-sales service if there is any problem with the installation or parts.



E-mail: cs.helper01@gmail.com

STEP 11

Parts required

 M8x50mm  **L** 20pcs



Please take care of the screws and contact the after-sales service if there is any problem with the installation or parts.



E-mail: cs.helper01@gmail.com

STEP 12

Parts required

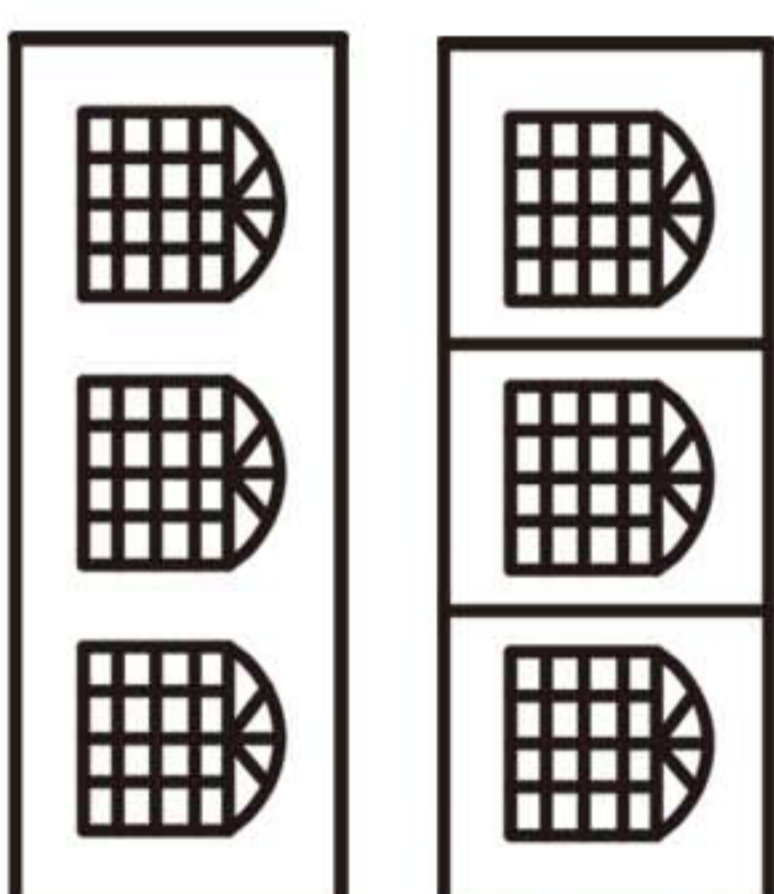

Q 2pcs



G 240pcs

Q1 4pcs





Please take care of the screws and contact the after-sales service if there is any problem with the installation or parts.



E-mail: cs.helper01@gmail.com

STEP 13

Parts required

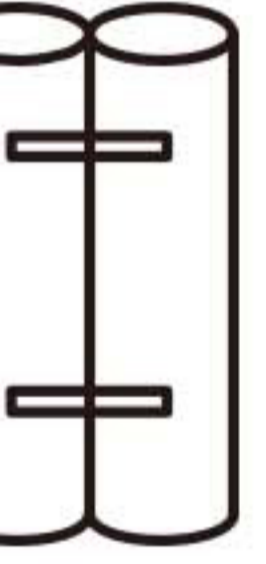
-  **H** 4pcs
-  **O** 4pcs
-  **N** 38pcs
-  4pcs



Please take care of the screws and contact the after-sales service if there is any problem with the installation or parts.



E-mail: cs.helper01@gmail.com