

























PARTS AND HARDWARE LIST

EXTRA HARDWARE INCLUDED FOR YOUR CONVENIENCE. ITEMS ARE NOT SHOWN TO SCALE.

①	Left Side Frame		x1
②	Middle Frame		x1
③	Right Side Frame		x1
④	Right Shelf		x2
⑤	Left Shelf		x2
⑥	Desktop		x1
⑦	Cross Bracing		x2
⑧	Steel Shelf		x1
⑨	Short Bar		x2
⑩	Bar		x2
⑪	Shelf		x1

⑫	Hook		x5
⑬	Shelf		x1
⑭	Shelf		x2

A	Screw 6x30mm		x10
B	Screw 6x12mm		x4
C	Screw 5x50mm		x16
D	Screw 4x12mm		x1
D1	Nut		x5
D2	Nut		x4
E	Screw 4x18mm		x4
F	Foot		x6
G	Screw		x4
H	Screw 6x45mm		x4
I	Allen Wrench		x1
J	Phillips Screwdriver		x1
K	Screw		x8

CAUTION

- READ THE INSTRUCTION MANUAL BEFORE ASSEMBLING.
- OPEN THE HARDWARE AS NEEDED.
- ASSEMBLE IN AN AREA WITH PLENTY OF SPACE.
- READ EACH STEP BEFORE BEGINNING CONSTRUCTION.
- DO NOT TIGHTEN THE SCREWS UNTIL ALL PARTS ARE IN RIGHT POSITIONS.
- NEVER FORCE THE SCREWS OR FITTINGS.
- KEEP THIS MANUAL FOR FUTURE REFERENCE.
- TIGHTEN ALL THE SCREWS EVERY 6 MONTHS.
- DO NOT SHIFT OR DRAG THE PRODUCT AFTER ASSEMBLY.
- POWER TOOLS SHOULD NOT BE USED TO ASSEMBLE THIS PRODUCT.

	YES
	NO

ASSEMBLY INSTRUCTION

STEP 1

Attach Four Feet (F) to Middle Frame (2) and Right Side Frame (3).

Attach Middle Frame (2) and Right Side Frame (3) to two Right Shelves (4) with Screws (C) (5X50mm) by Allen Wrench (I).

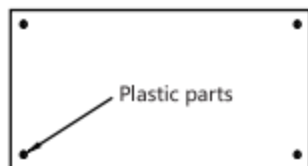
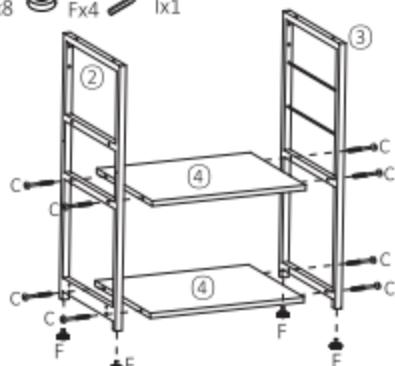

NOTE: When assembling the shelves, the smooth side of each board should face upward, and the sides with the plastic inserts should face downward.

STEP 2

Attach Two Feet (F) to Left Side Frame (1).

Attach Short Bars (9) to Left Frame (1) and Middle Frame (2) with Screws (G) by Phillips Screwdriver (J). Then attach Left Side Frame (1) and Middle Frame (2) to two Left Shelves (5) with Screws (C) (5X50mm) by Allen Wrench (I).

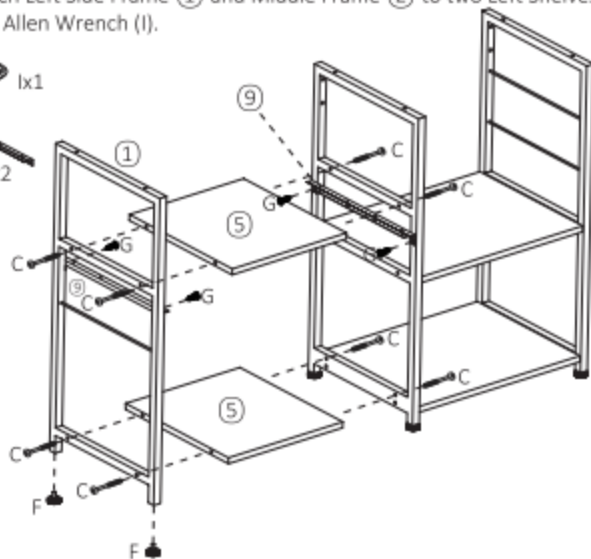

ASSEMBLY INSTRUCTION

STEP 5 -----

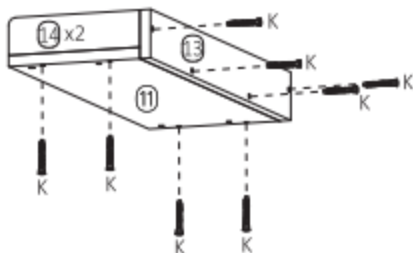
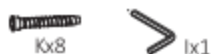

STEP 6 -----

Attach two Bars (10) to Right Side Frame (3) and Middle Frame (2) with Screws (H) (6 x 45mm) and Nuts (D2) by Allen Wrench (I). Attach Shelf (11) to Bars (10) with Screws (C) (6 x 30mm) by Allen Wrench (I).

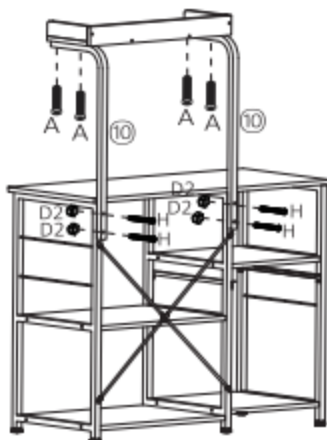

ASSEMBLY INSTRUCTION

STEP 7

Place Steel Shelf (8) as shown. Then attach Steel Shelf (8) to Short Bars (9) with Screws (E) (4x18mm) and Nuts (D1) by Allen Wrench (I).

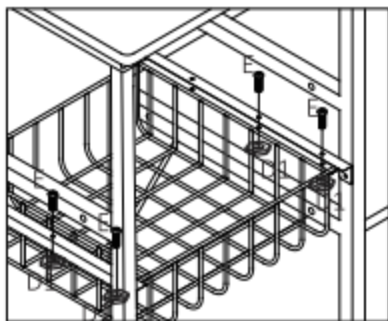
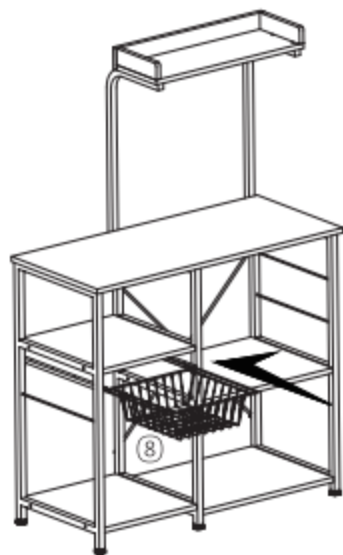

ASSEMBLY ACCOMPLISHED

Maximum weight capacity
= 66 KG

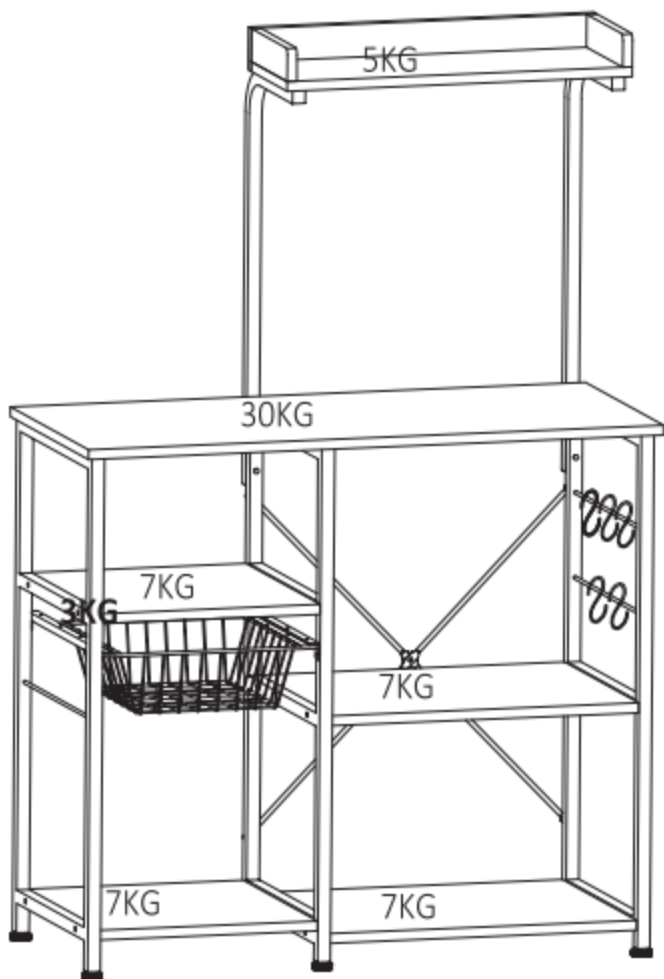

ASSEMBLY INSTRUCTION

STEP 3

Attach two Cross Bracings (7) to Right Side Frame (3) and Middle Frame (2) with Screws (B) by Allen Wrench (I). Using Screw (B) (6 x 12mm) and Screw Nut (D) to fix the middle of two Cross Bracings (7) by Allen Wrench (I).

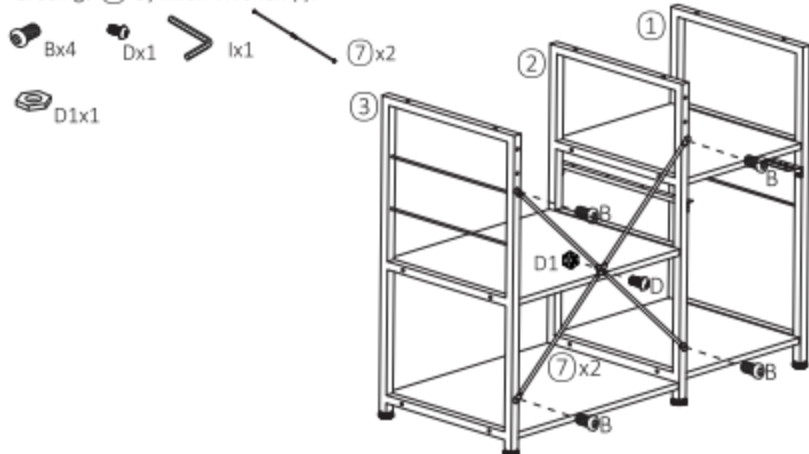

STEP 4

Attach Desktop (6) to Left Side Frame (1), Middle Frame (2) and Right Side Frame (3) with Screws (A) (6x30mm) by Allen Wrench (I).

