

# Assembly Instructions

## Case & Maintenance



Not for commercial use. For residential use only.



Furniture may scratch floors. We recommend using furniture pads to protect your floors.



Do not put hot items directly on furniture surface.



Do not clean furniture with harsh cleansers or polish.



Do not place furniture under direct sunlight.



Do not write on furniture near heating or cooling vents.



Do not write on furniture without a padded barrier to protect the surface.



Do not place furniture outside for indoor use only



Stains may be removed with mild soap solution and damp cloth.



Children should not climb or jump on the furniture.



Dust and pick-upspills using a clean, non-colored, lint-free cloth.

Please look in the box for hardware packs and legs.

Sets oftenship in multiple boxes and may arrive a day or two apart.

# California King Bed

## Part List

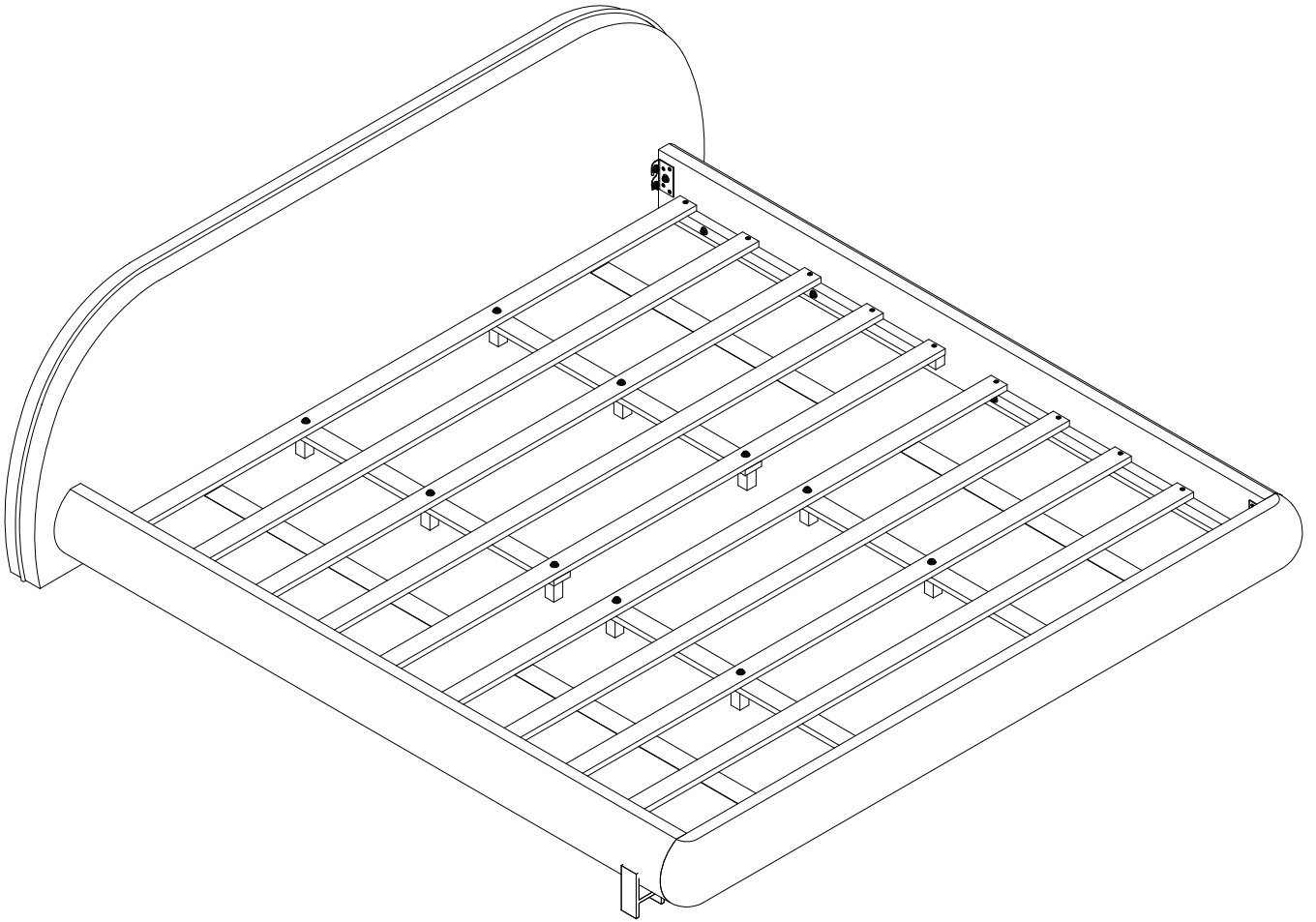

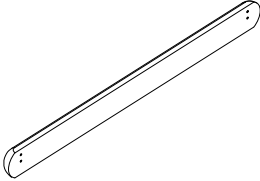
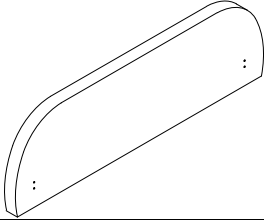
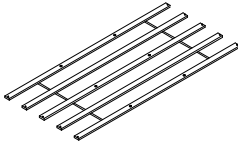
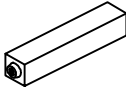
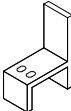
Label	Picture	Description	QTY
3		Footboard	1pc
4		Headboard	1pc
5		Slats	2pcs
8		Center Support Leg	12pcs
9		Footboard Leg	2pcs



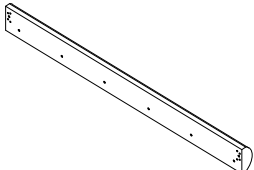
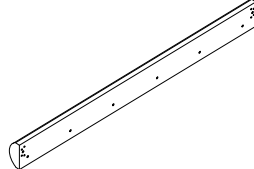
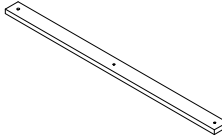
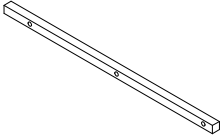

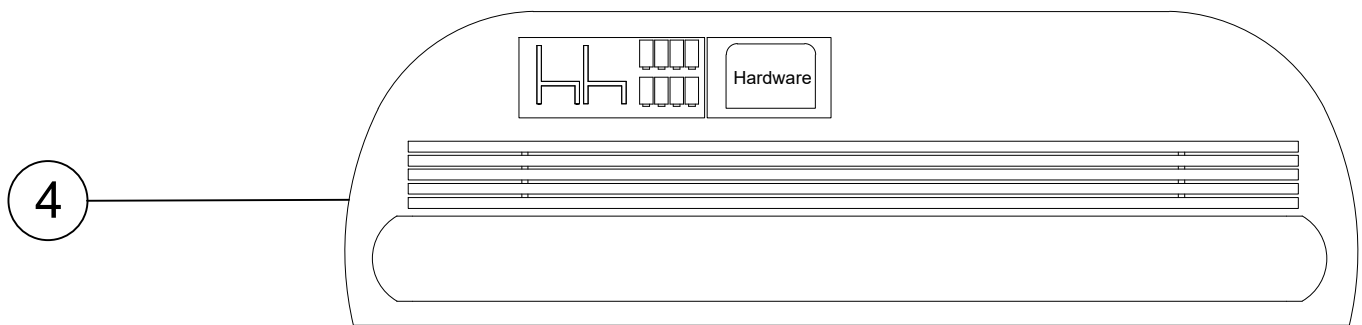
## Part List

①		Side Rail (R)	1pc
②		Side Rail (L)	1pc
⑥		Middle Support Bar	4pcs
⑦		Support Rail	4pcs

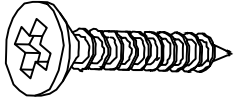
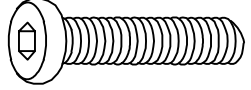
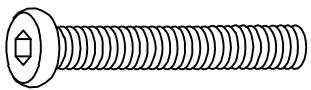
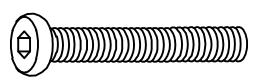

Noted : Footboard(3), Slats (5). Center Support Leg (8), Footboard Leg(9) and Hardware are packaged behind the Headboard (4).



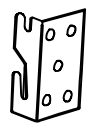
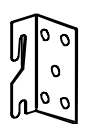
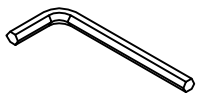



# Hardware

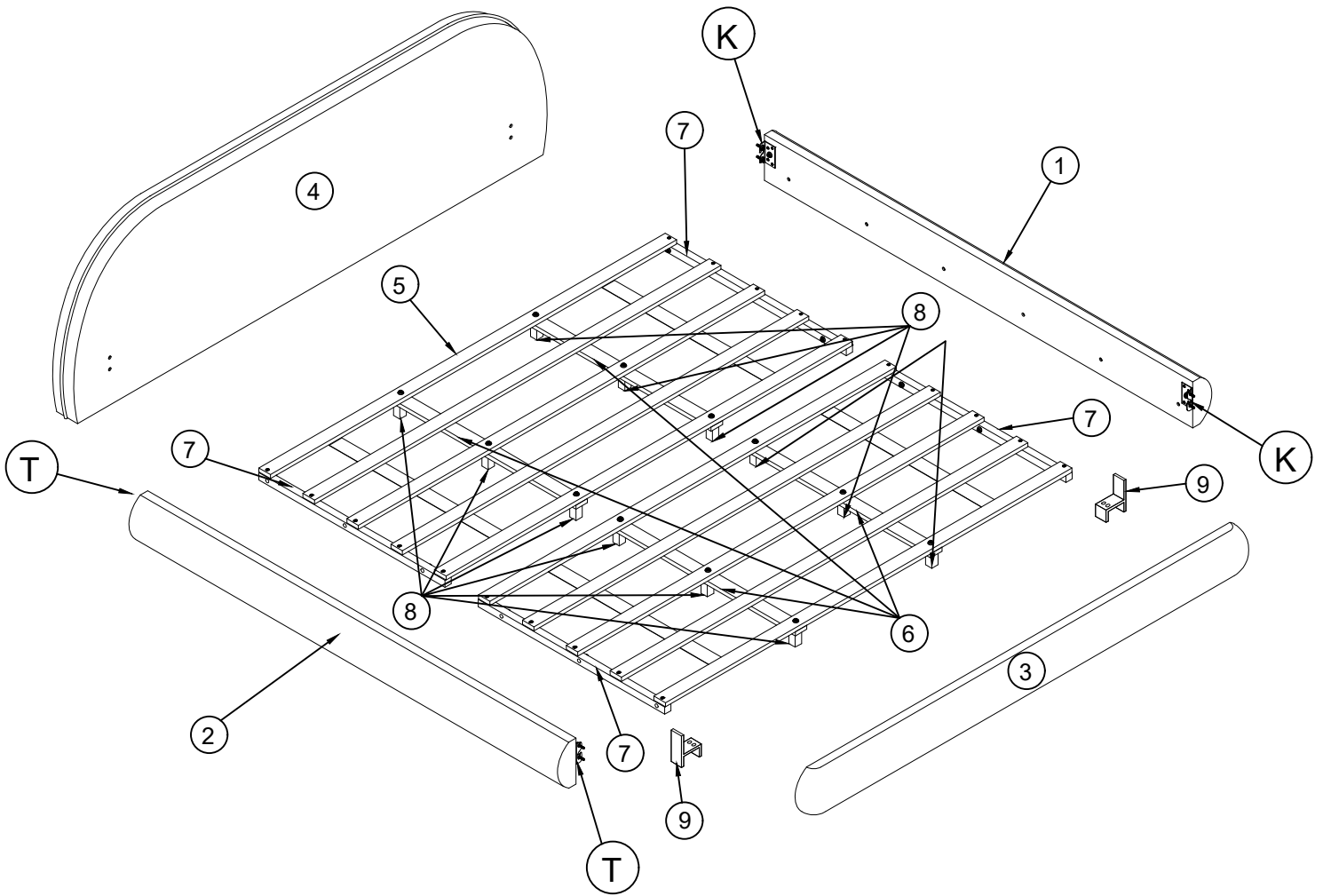

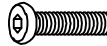

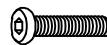
Label	Picture	Description	QTY
A		Screw(4x30mm)	36+1pcs
B		Bolts(5/16"x30mm)	12+1pcs
C		Bolts(5/16"x50mm)	12+1pcs
D		Bolts(1/4"x50mm)	16+1pcs
E		Lock washer(5/16")	24+1pcs
F		Flat washer(5/16")	24+1pcs
G		Lock washer(1/4")	16+1pcs
H		Flat washer(1/4")	16+1pcs
T		Metal pad(L)	2pcs
K		Metal pad(R)	2pcs
M		Allen Wrench(M4)	1+1

# Assembly Preparation

Before Beginning assembly:



A  x 36pcs+1	C  x 12pcs+1	E  x 24pcs+1	G  x 20pcs+1
B  x 12pcs+1	D  x 20pcs+1	F  x 24pcs+1	H  x 20pcs+1
			M  x 1pcs+1

-  Read the instructions cover to cover
-  Have 2 adults on hand for assembly
-  Do not assemble on flooring or carpet
-  Assemble on a clean, non-marring surface (packing foam)
-  Save all packaging until finished

# Assembly Steps

## OVERVIEW

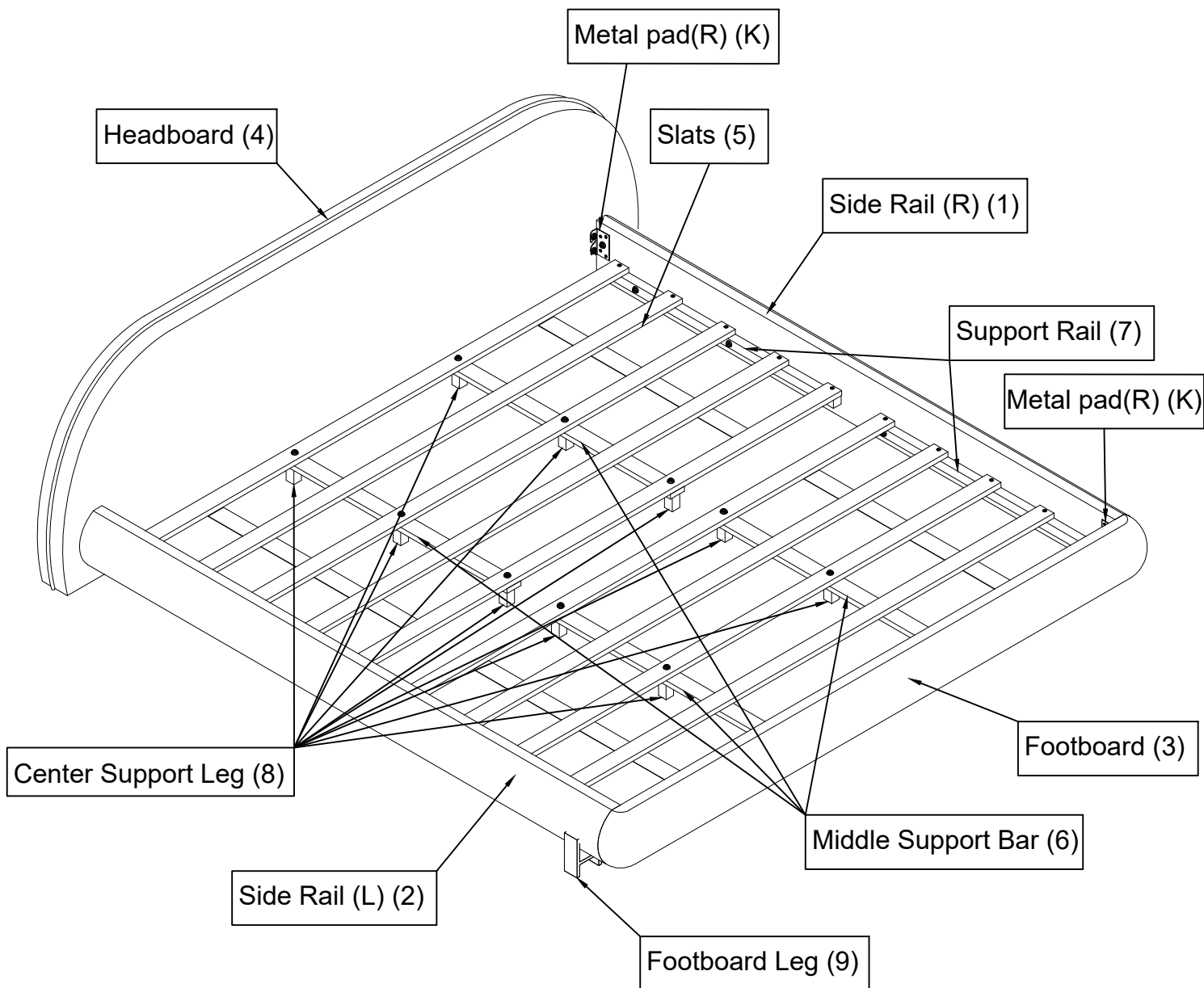

## FRONT FACING

This Bed have multiple parts and may require up to 30 minutes to assemble. To give you an overview of the Bed parts, the above picture is to help you put the various parts into perspective. Please read through the instructions below to familiarise yourself with the parts and steps before assembly.

Note: It is recommended that you have an adult partner to assist during the entire assembly process.

# Step 1

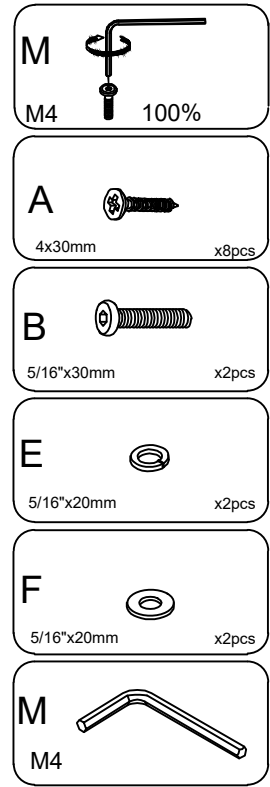
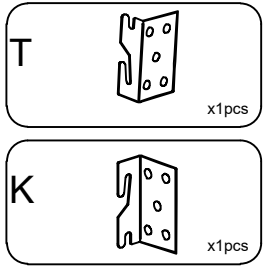
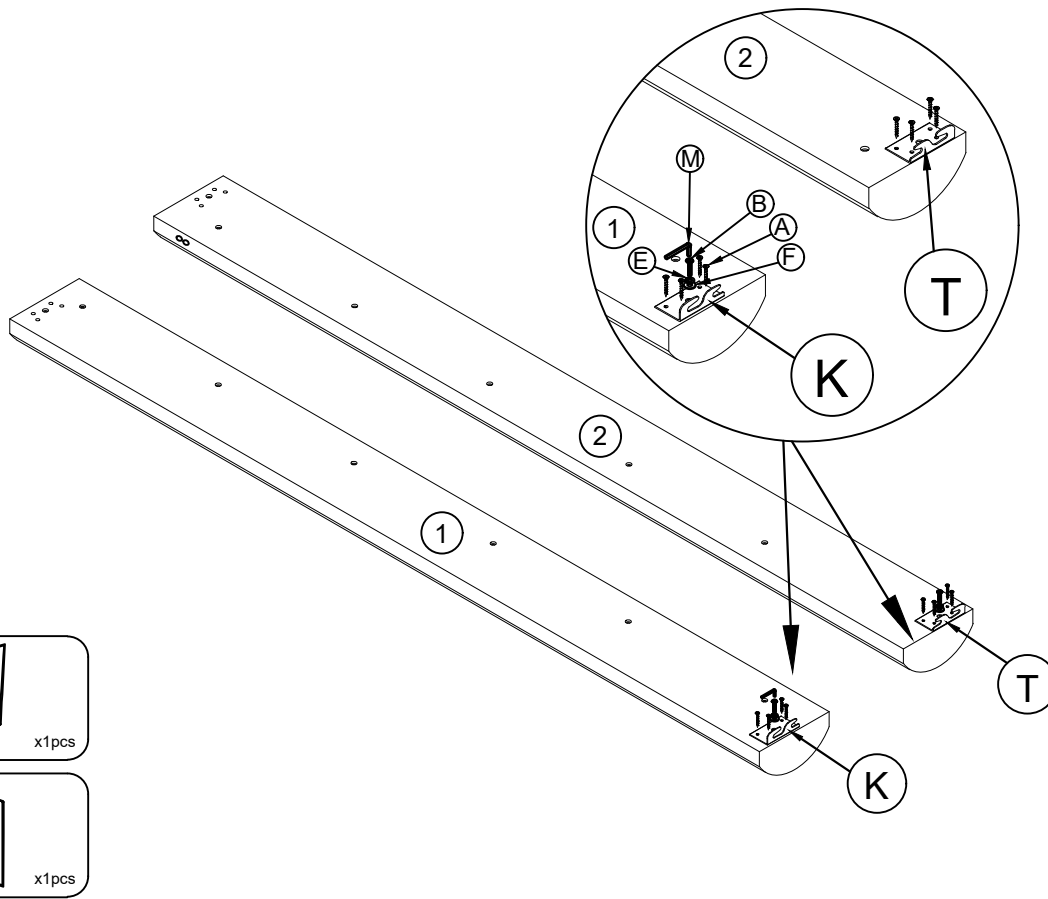

Attach Metal Pad (K) to Side Rail (R) (1), attach Metal Pad (T) to Side Rail (L) (2) by using Screw (A), Bolts (B), Lock Washer (E), and Flat Washer (F).

# Step 2

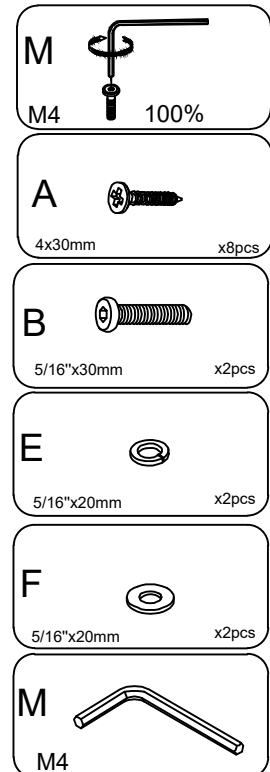
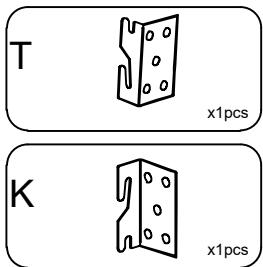
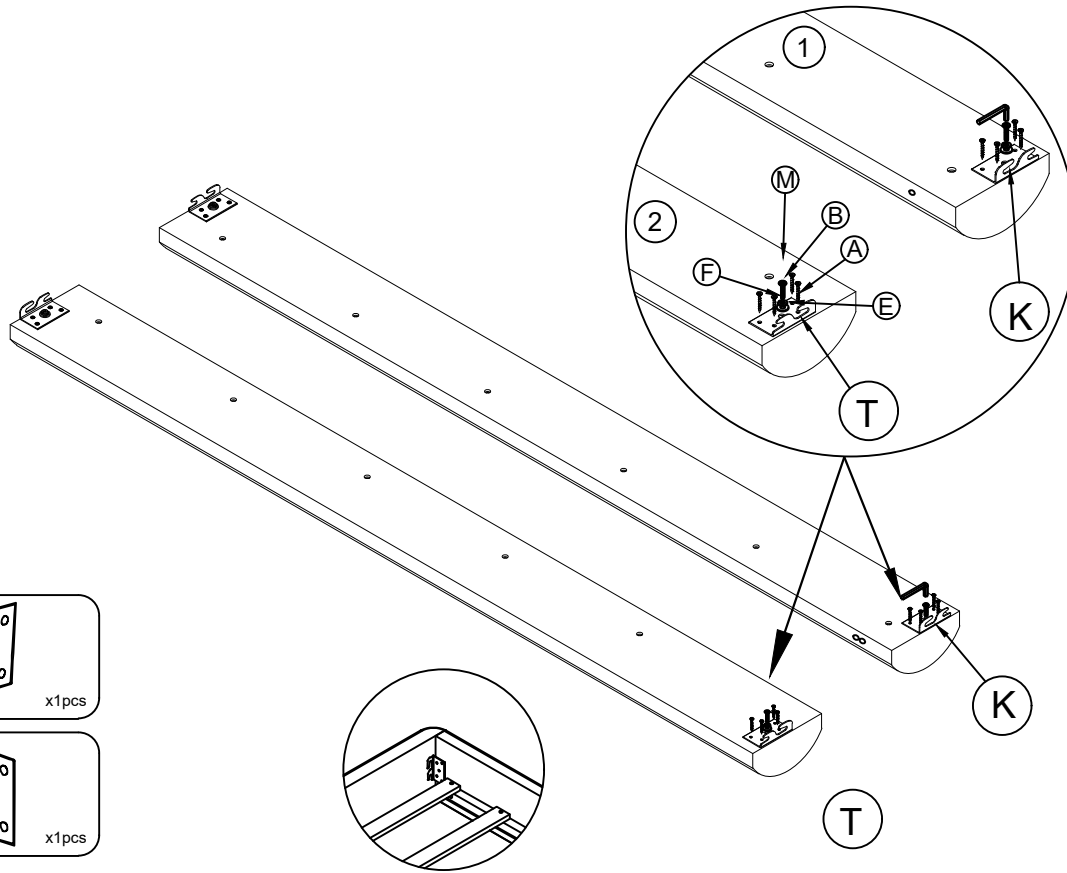



Use Metal Pad (T) to attach to Side Rail (R) (1), and use Metal Pad (K) to attach to Side Rail (L) (2) by using Screw (A) and Bolt (B) with the M4 Allen Wrench (M).

Note: Make sure the Metal Pads are oriented correctly, as this side will connect to the Footboard (3).

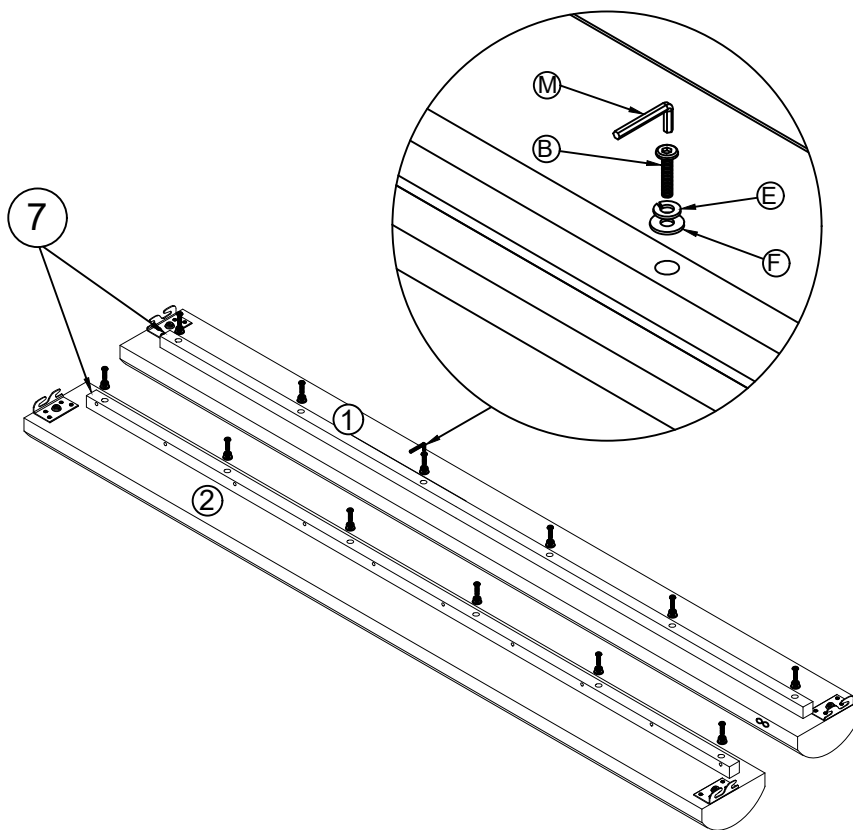
# Step 3

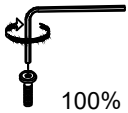

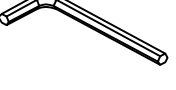
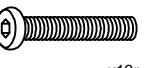

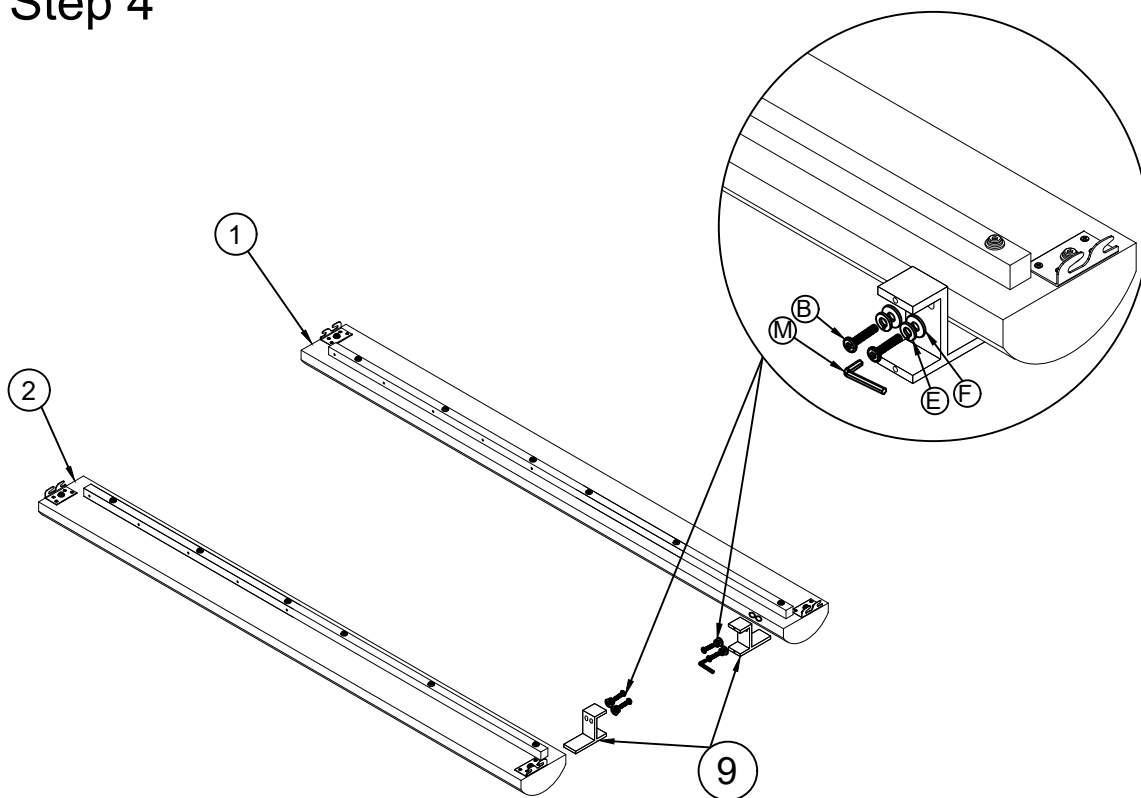

- M  M4 100%
- E  5/16" x12pcs
- F  5/16" x12pcs
- M  M4
- C  5/16"x50mm x12pcs

Attach Support Rail (7) to Side Rail (R) (1) and Side Rail (L) (2) by using Bolts (C), Lock Washer (E) and Flat Washer (F) with M4 Allen Wrench (M).

# Step 4

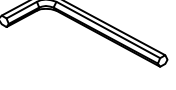

- D  1/4"x50mm 4pcs
- G  1/4" x4pcs
- H  1/4" x4pcs
- M  M4
- M  M4 100%

Attach the Footboard Leg (9) to the Side Rail (R) (1) and Side Rail (L) (2) . Use Bolts (D), Lock Washer (G) and Flat Washer (H) with M4 Allen Wrench (M) to secure them together.

# Step 5

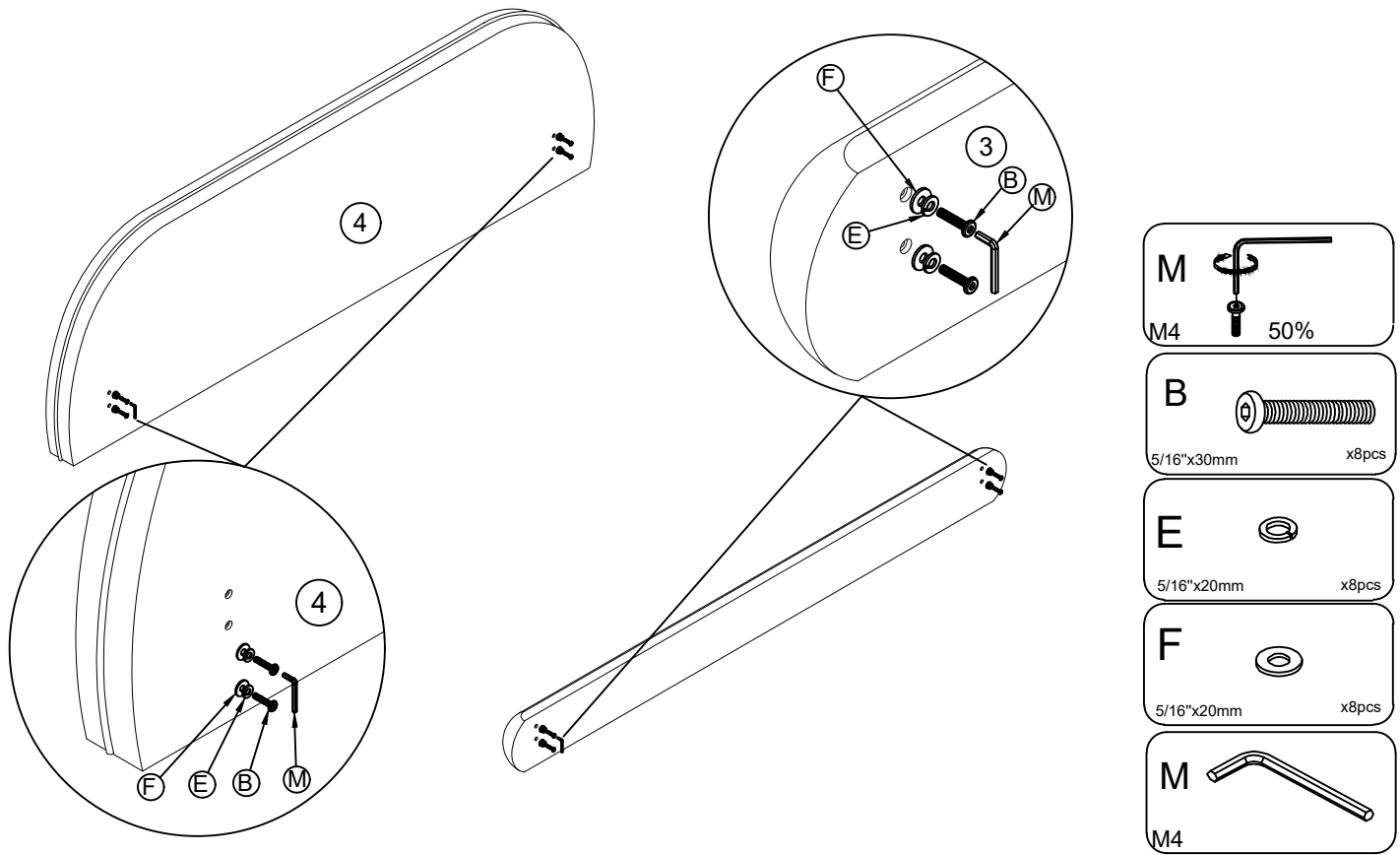

Use Bolts (B), Lock Washer (E) and Flat Washer (F) with M4 Allen Wrench (M). Then attach 50% Bolts (B) to Headboard (9) and Footboard (3).

# Step 6

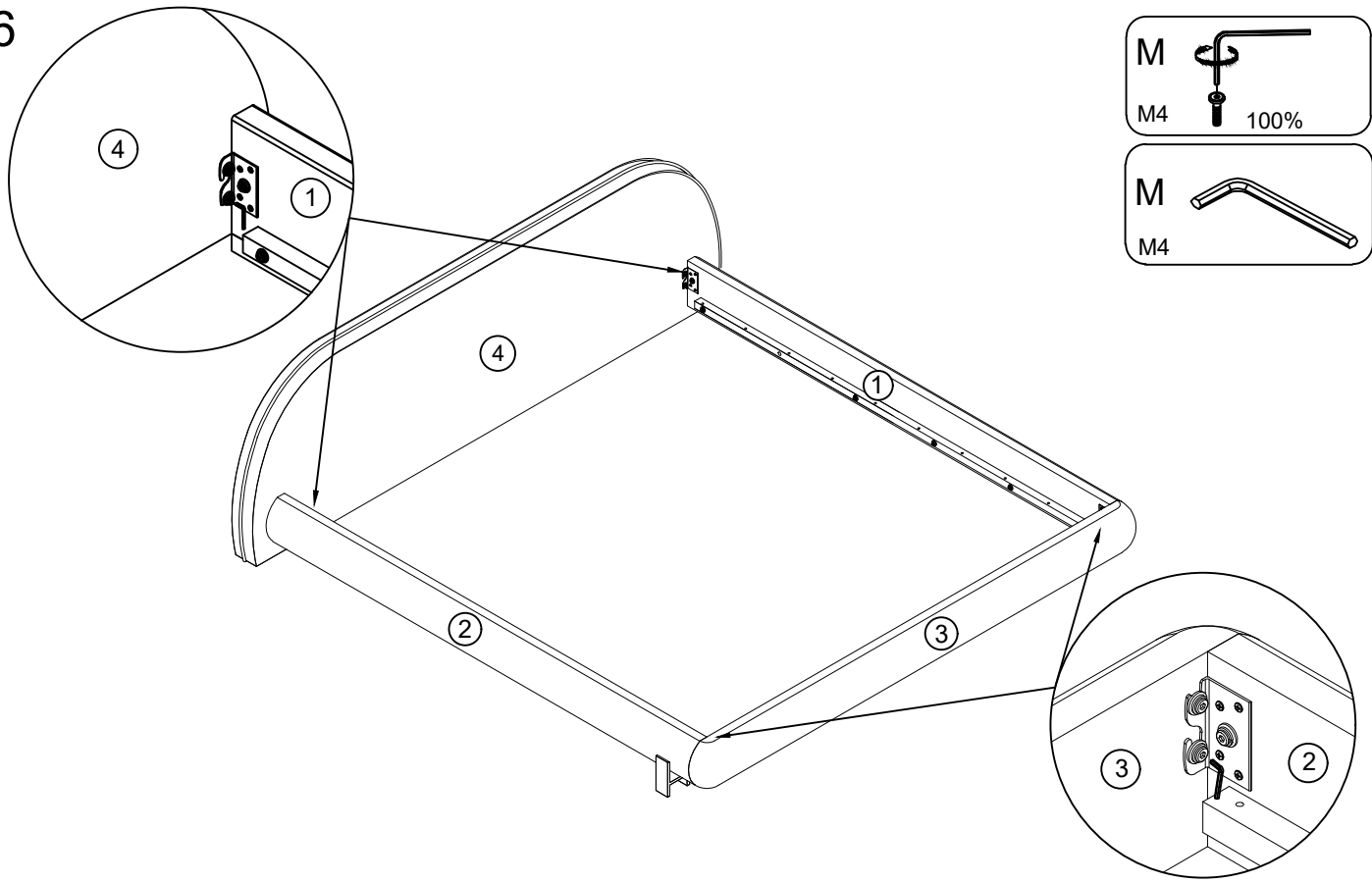

Attach Side Rail (1) and Side Rail (2) to Headboard (4) (the direction of the Metal Pad is down) by using M4 Allen Wrench (M) to tighten Bolts (B). Then attach Footboard (3) to Side Rail (R) (1) and Side Rail (L) (2) by using M4 Allen Wrench (M) to tighten Bolts (B).

# Step 7

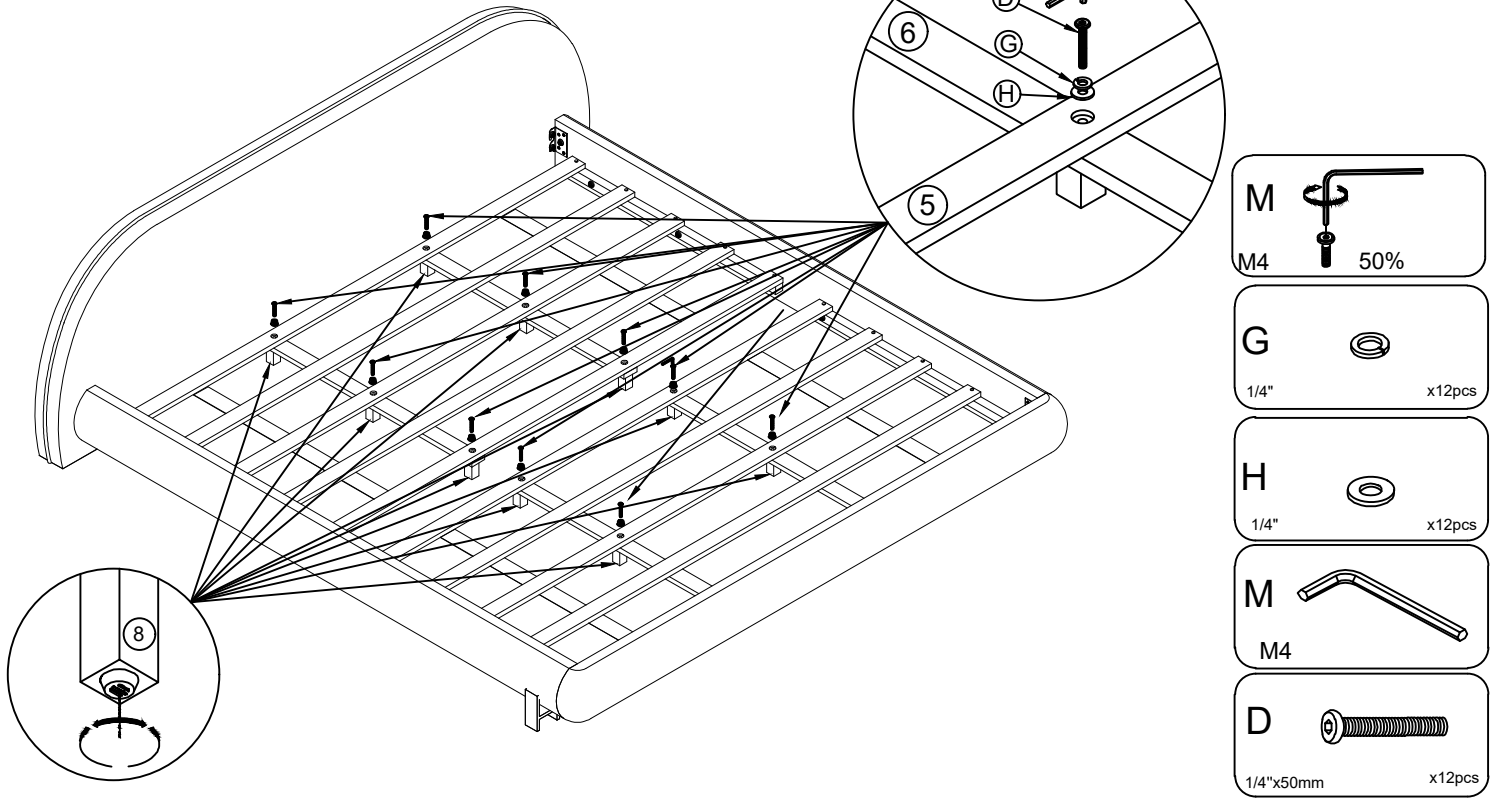

Align assembly position on Middle Support Bar (6) with Center Support Leg (8) and Slats (5). Then attach them by using Bolts (D), Lock Washer (G) with Flat Washer (H) with M4 Allen Wrench (M).

# Step 8

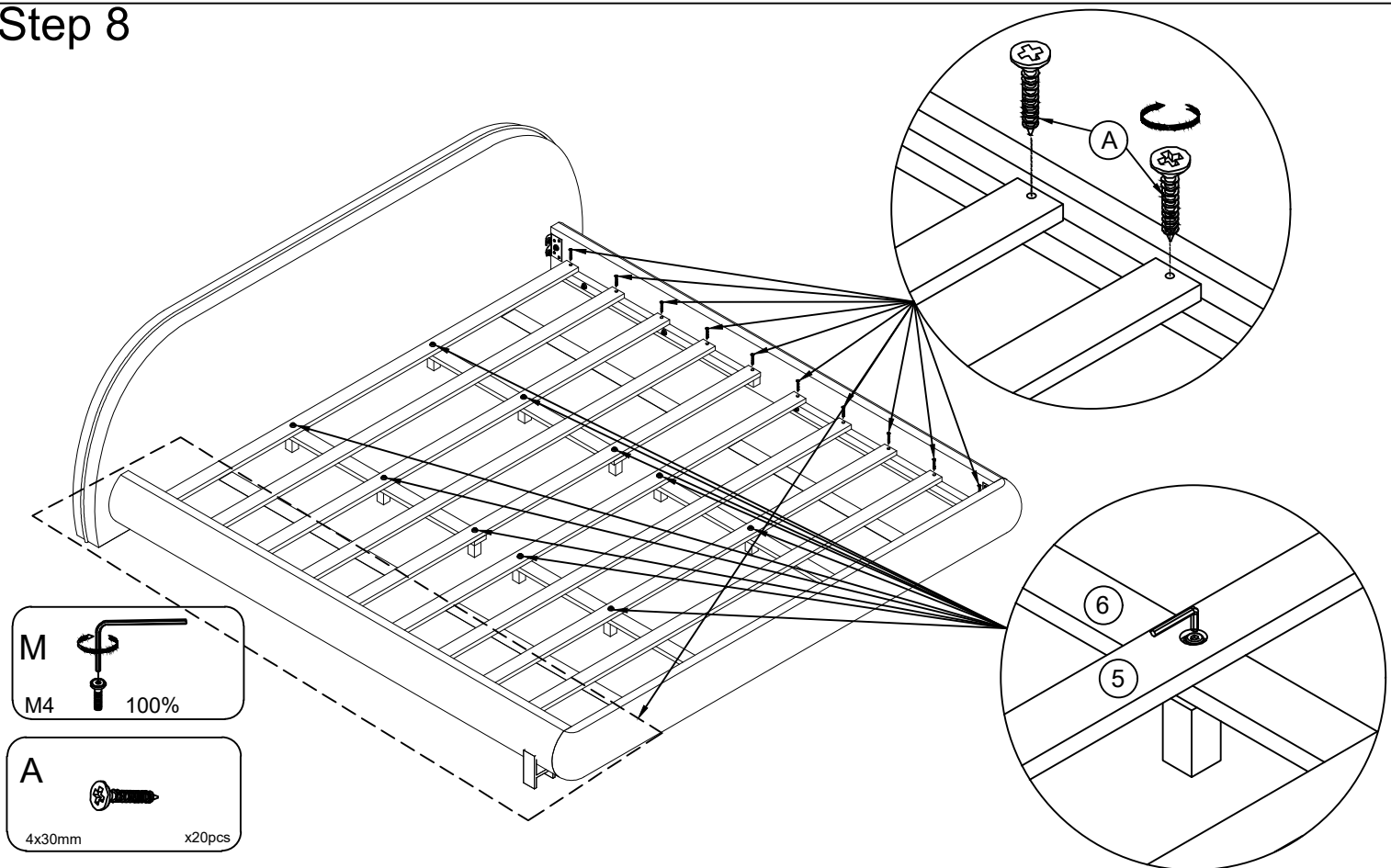

Use Screw (A) to attach Slats (5) to the Support Rail (7) of Side Rail (R) (1) and Side Rail (L) (2). Finally, use the M4 Allen Wrench (M) to fully tighten the Bolts (D) into the Slat (5) and Middle Support Bar (6).

## Finish

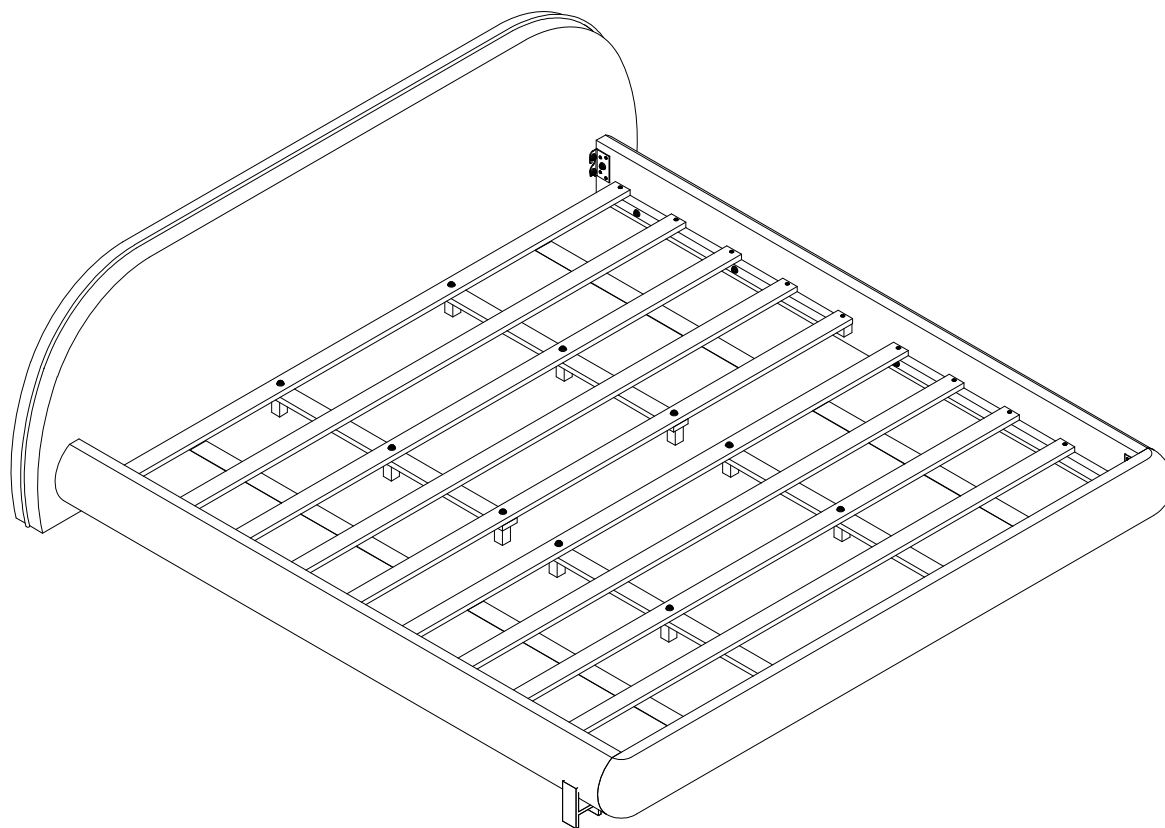

Thank you for your trust and preference in using our products.  
The product will bring you a peaceful sleep forever

Place the Bed on a **LEVEL SURFACE**.

Inspect it and make sure all parts are adequately connected.

Don't push too hard, shake on the bed.

This would help to align all the parts at the joint areas.

**CAUTION 1:** When tightening these screws, tighten sequentially.

**DO NOT** tighten any screws fully and then towards the next one.

This would cause the frame to warp.

If there is still wobbles, loosen the screws and execute this same process.

**DO NOT** tighten any screws fully and then towards the next one.

**WARNING!!**

**IF BED IS NOT STABLE, IT COULD LEAD TO DAMAGING THE PRODUCT.**

Ensure all screws are fully locked into position.

The bed is ready to be used.

**Caution 2:** This bed can only be used on a flat, level surface.