

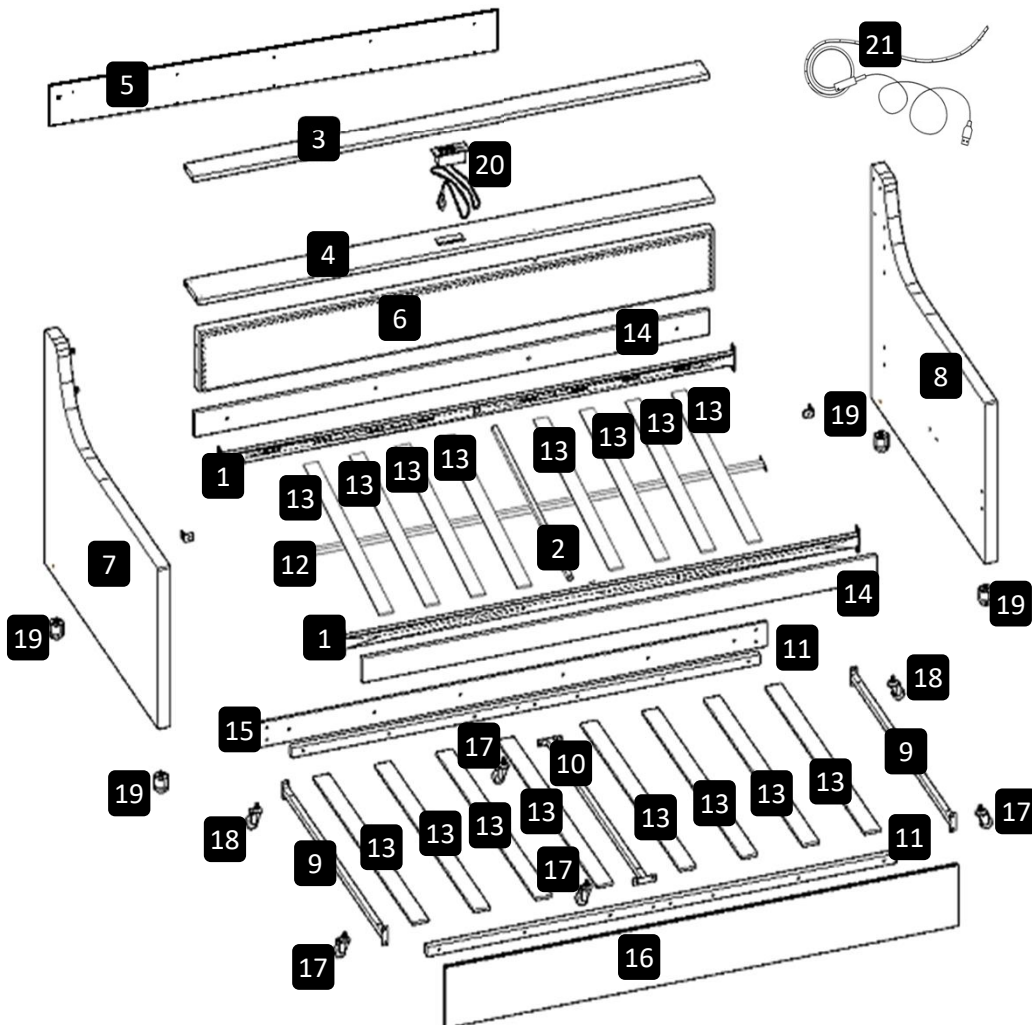

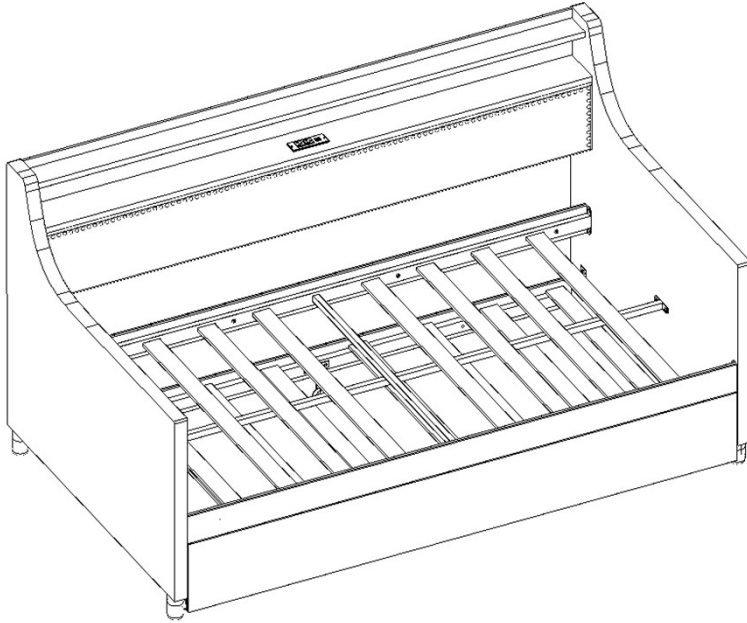

ASSEMBLY INSTRUCTION

- TIPS**
1. This bed fit standard twin mattress 75" L x 39" W.
 2. Always use the recommended size mattresses or mattress supports, or both, to help prevent the likelihood of entrapment or falls.
 3. Do not allow horseplay on or under the bed and prohibit jumping on the bed.
 4. Do not use substitute part. Contact the manufacture or dealer for replacement part.

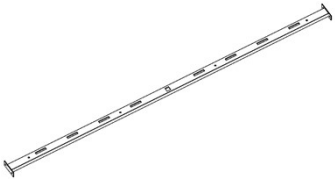
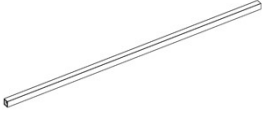

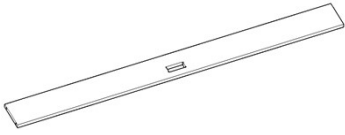
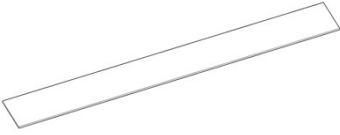
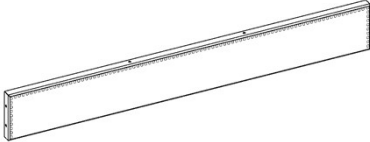
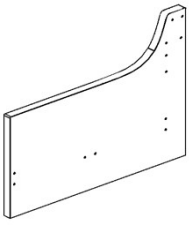
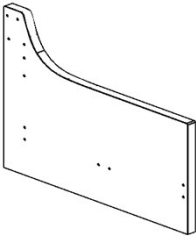
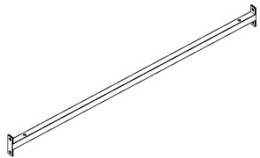
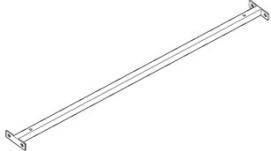
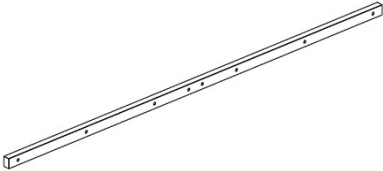

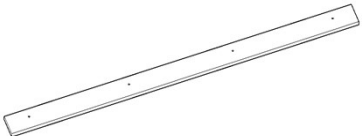
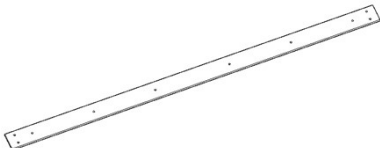
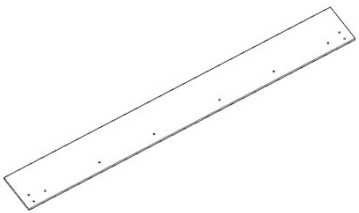
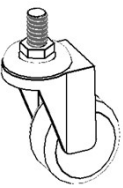
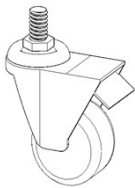



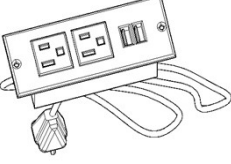
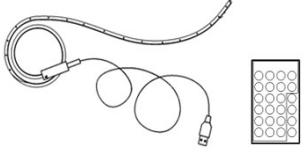



Part List

<p>1</p>  <p>Metal Slat Frame x2</p>	<p>2</p>  <p>Rail x1</p>	<p>3</p>  <p>Panel x1</p>
<p>4</p>  <p>Panel x1</p>	<p>5</p>  <p>Backboard x1</p>	<p>6</p>  <p>Headboard x1</p>
<p>7</p>  <p>Left Handrail x1</p>	<p>8</p>  <p>Right Handrail x1</p>	<p>9</p>  <p>Side Support Iron x2</p>
<p>10</p>  <p>Middle Support Iron x1</p>	<p>11</p>  <p>Support Slat x2</p>	<p>12</p>  <p>Long Support Iron x1</p>
<p>13</p>  <p>Slats x16</p>	<p>14</p>  <p>Panel x2</p>	<p>15</p>  <p>Back Trundle Panel x1</p>
<p>16</p>  <p>Front Trundle Panel x1</p>	<p>17</p>  <p>Caster x4</p>	<p>18</p>  <p>Brake Caster x2</p>

Part List

<p style="text-align: center;">19</p>  <p style="text-align: center;">Plastic Feet x4</p>	<p style="text-align: center;">20</p>  <p style="text-align: center;">Socket X1</p>	<p style="text-align: center;">21</p>  <p style="text-align: center;">Lamp Strip Kit x1</p>
---	---	---

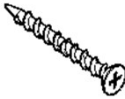
Hardware List

<p style="text-align: center;">A</p>  <p style="text-align: center;">Bolts(M6X10mm) X8</p>	<p style="text-align: center;">B</p>  <p style="text-align: center;">Bolts(M6X16mm) X32</p>	<p style="text-align: center;">C</p>  <p style="text-align: center;">Bolts(M6X30mm) X8</p>
<p style="text-align: center;">D</p>  <p style="text-align: center;">Bolts(M6X35mm) X17</p>	<p style="text-align: center;">E</p>  <p style="text-align: center;">Angle iron x2</p>	<p style="text-align: center;">F</p>  <p style="text-align: center;">Angle iron x8</p>
<p style="text-align: center;">G</p>  <p style="text-align: center;">Allen Key X1</p>	<p style="text-align: center;">H</p>  <p style="text-align: center;">Flat Gasket X16</p>	<p style="text-align: center;">I</p>  <p style="text-align: center;">Screws (M3X12mm) X9</p>
<p style="text-align: center;">J</p>  <p style="text-align: center;">Screws (M4X25mm) X10</p>	<p style="text-align: center;">K</p>  <p style="text-align: center;">P-Shaped Iron Sheet x3</p>	<p style="text-align: center;">L</p>  <p style="text-align: center;">Foam Pad X8</p>

Step1



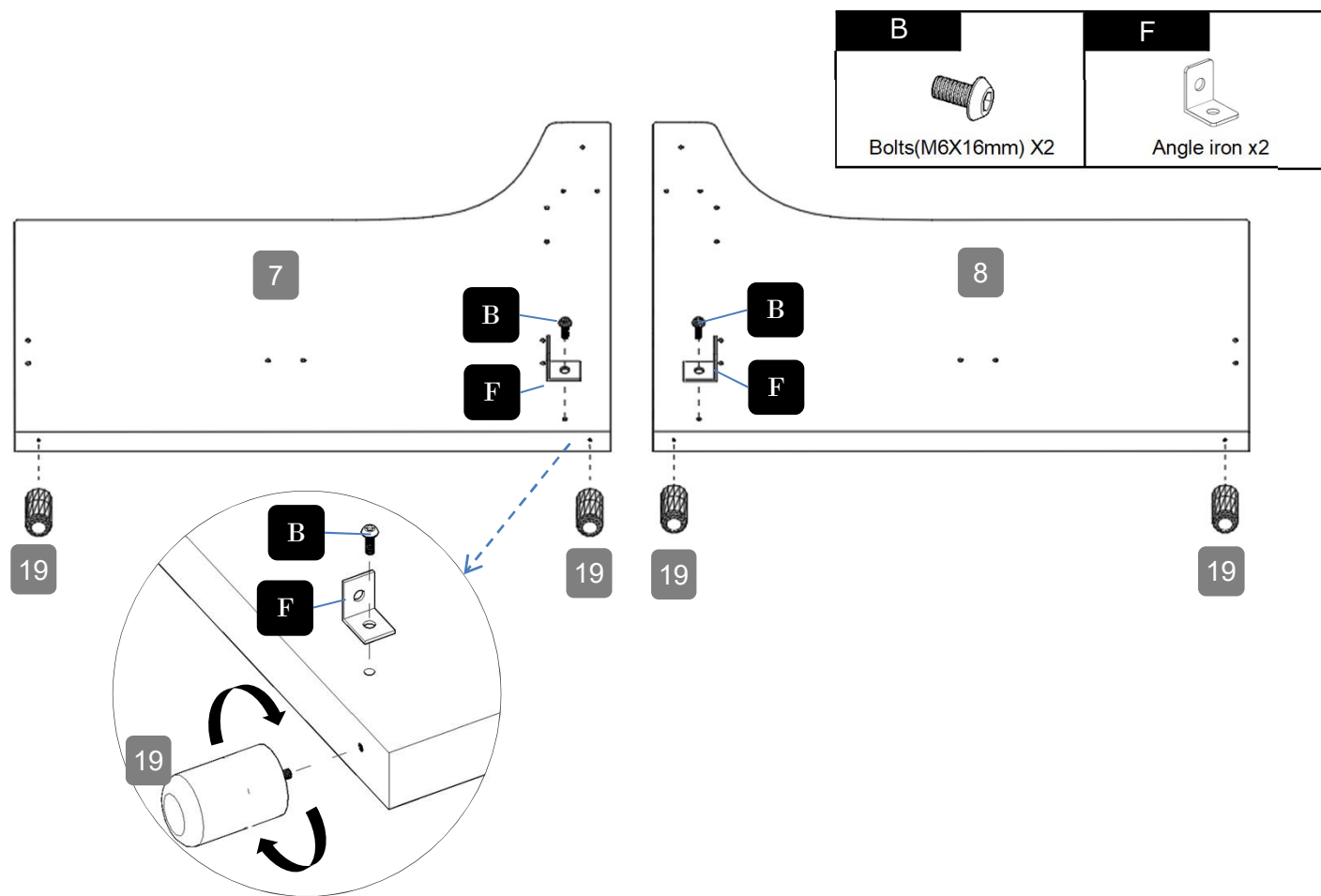

Attention: Do not tighten the screws before completing the entire installation. If you have any difficulty with the installation process, please feel free to contact us.

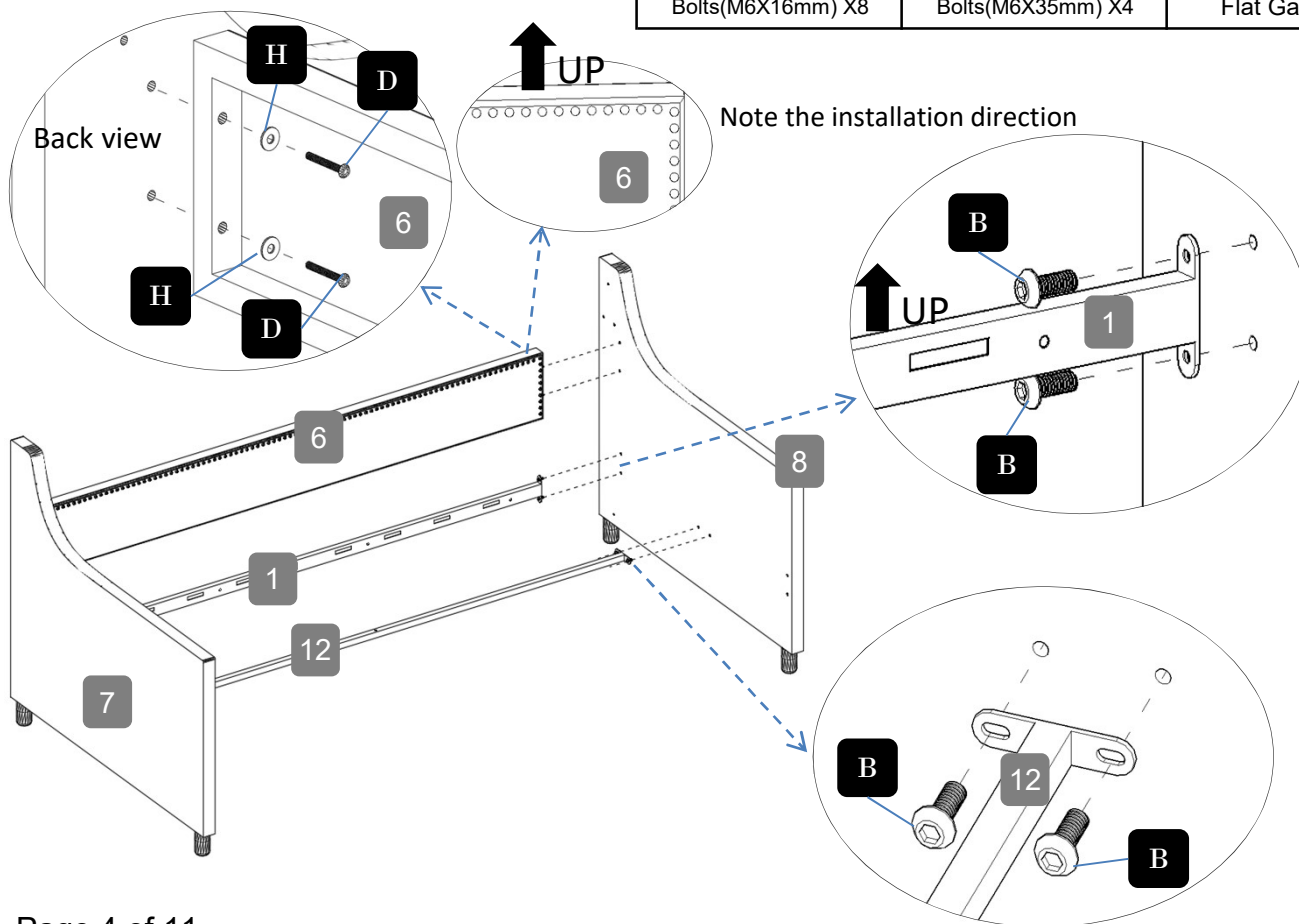
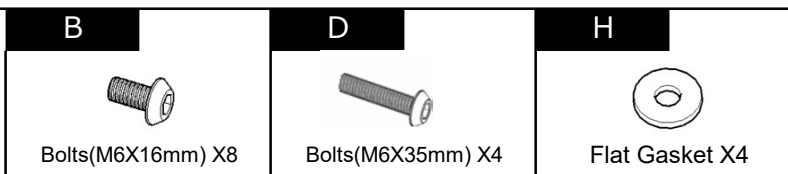

Step2



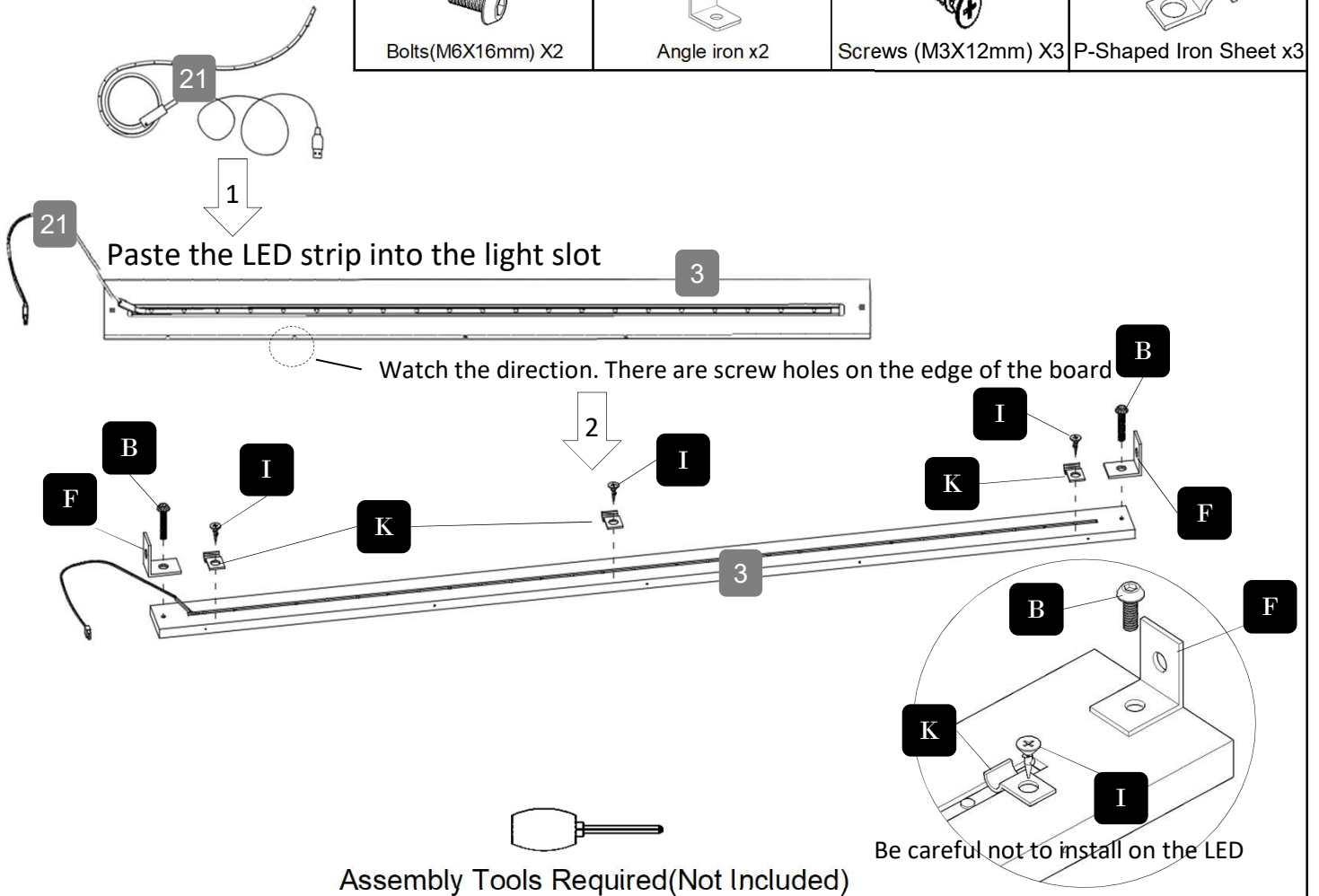

Step3

B  Bolts(M6X16mm) X2	F  Angle iron x2	I  Screws (M3X12mm) X3	K  P-Shaped Iron Sheet x3
---	---	---	--



Step4

B  Bolts(M6X16mm) X4	F  Angle iron x4	I  Screws (M3X12mm) X2
--	--	--

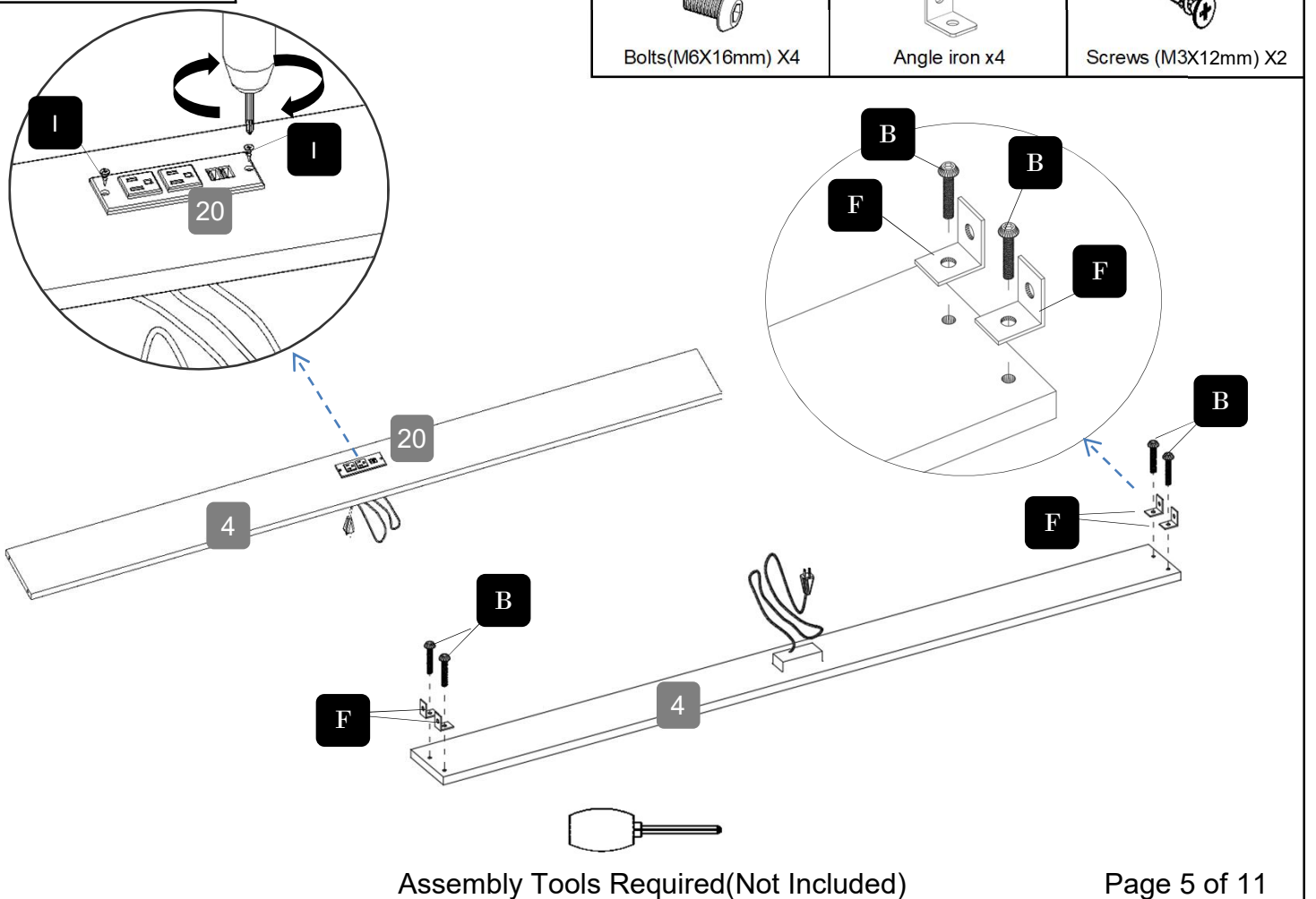

Step5

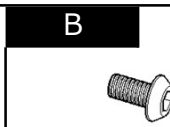

Bolts(M6X16mm) X6



Angle iron x2



Screws (M3X12mm) X4

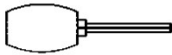
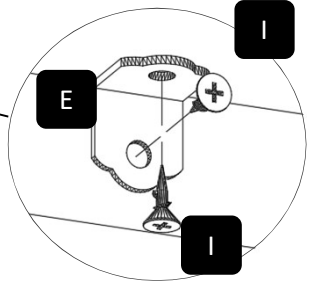
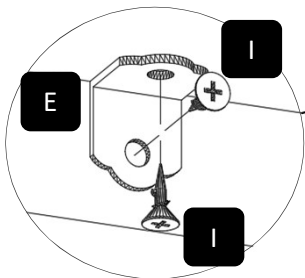
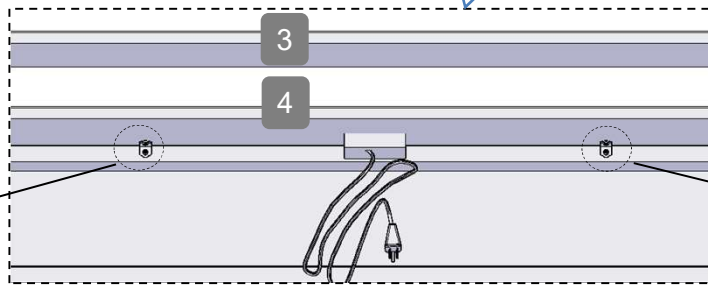
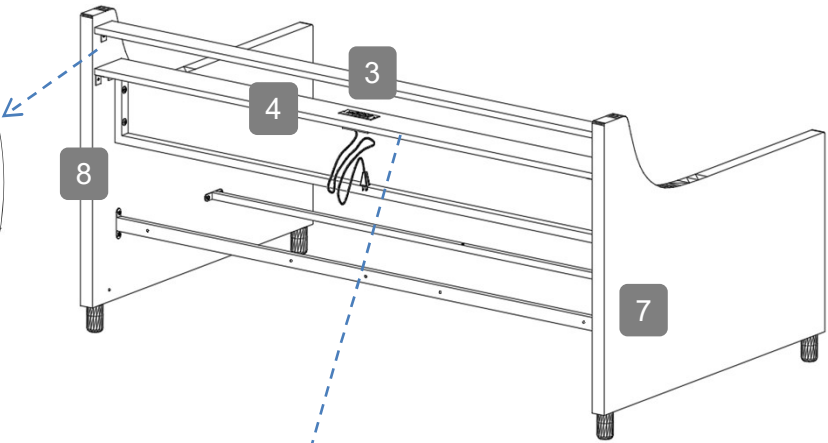
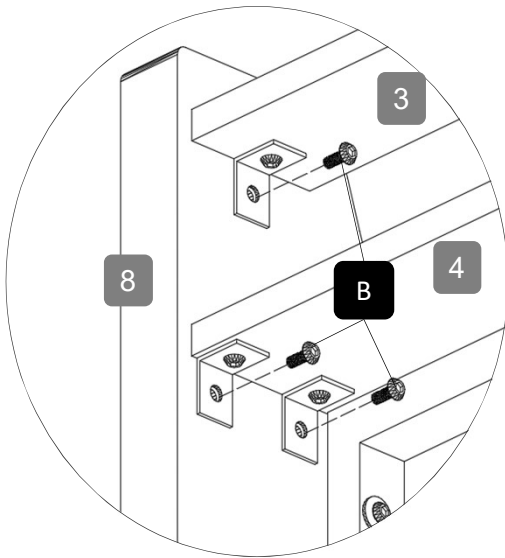

Assembly Tools Required(Not Included)

Step6



Screws (M4X25mm) X10

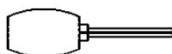
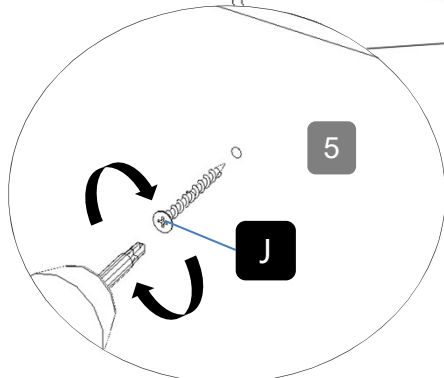
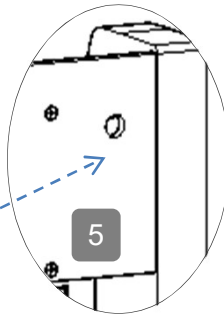
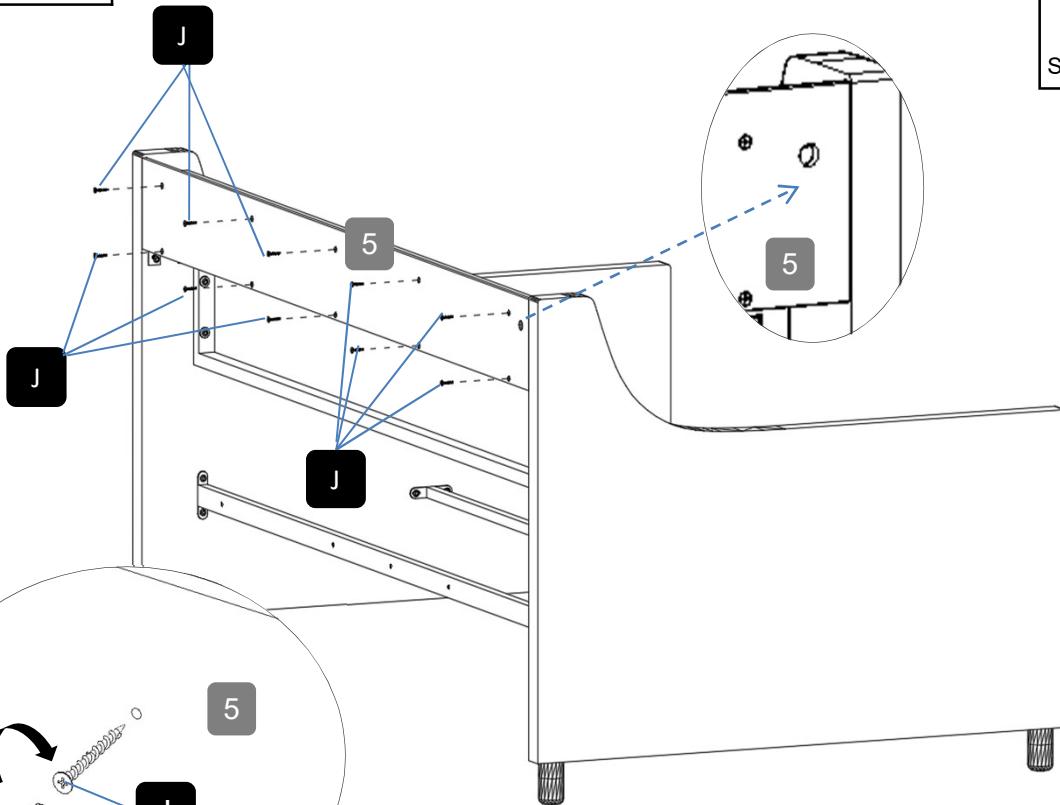

Assembly Tools Required(Not Included)

Step7

B



Bolts(M6X16mm) X1

D



Bolts(M6X35mm) X1

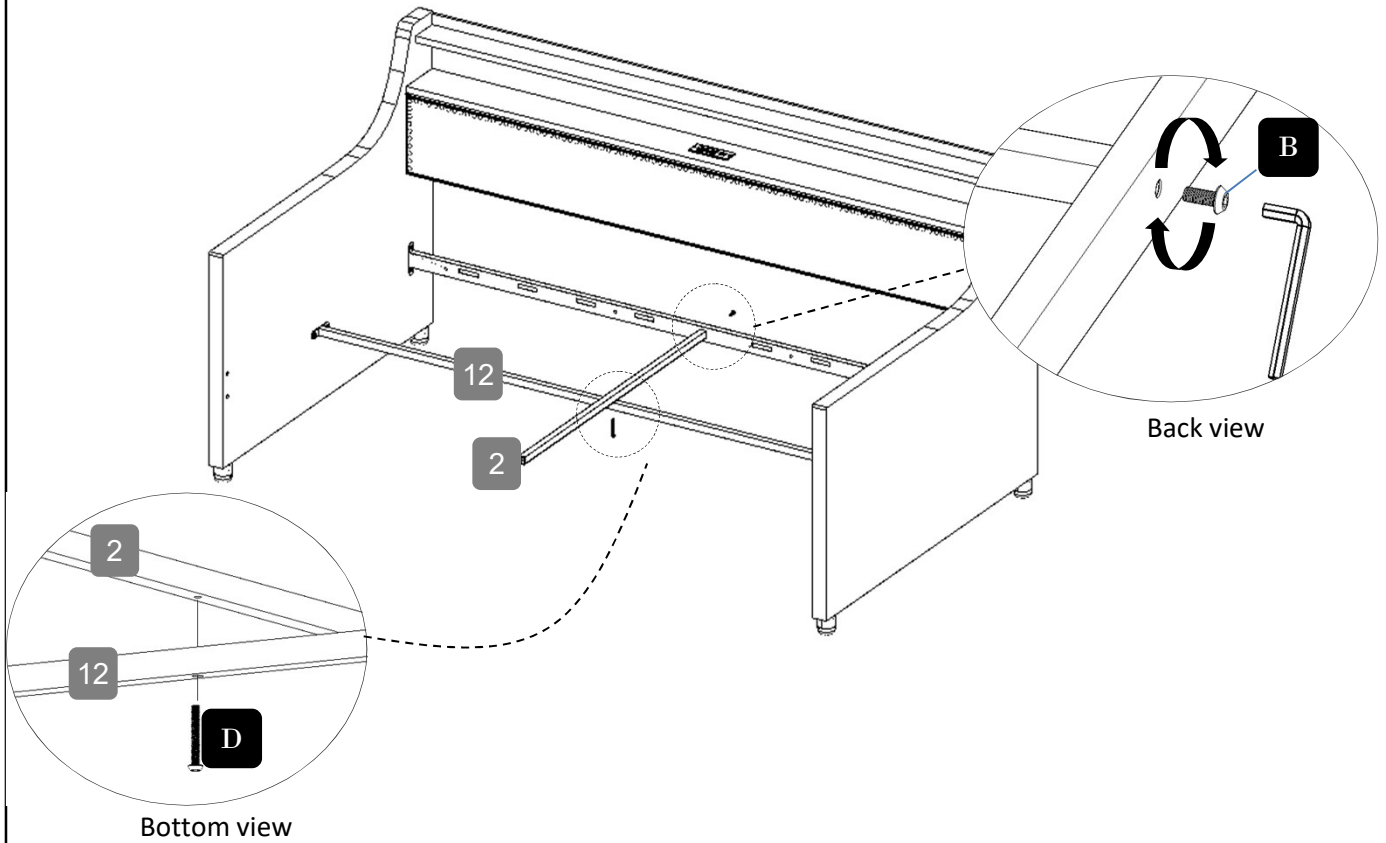

Back view

Bottom view

Step8

L

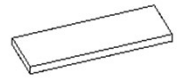

Foam Pad X8

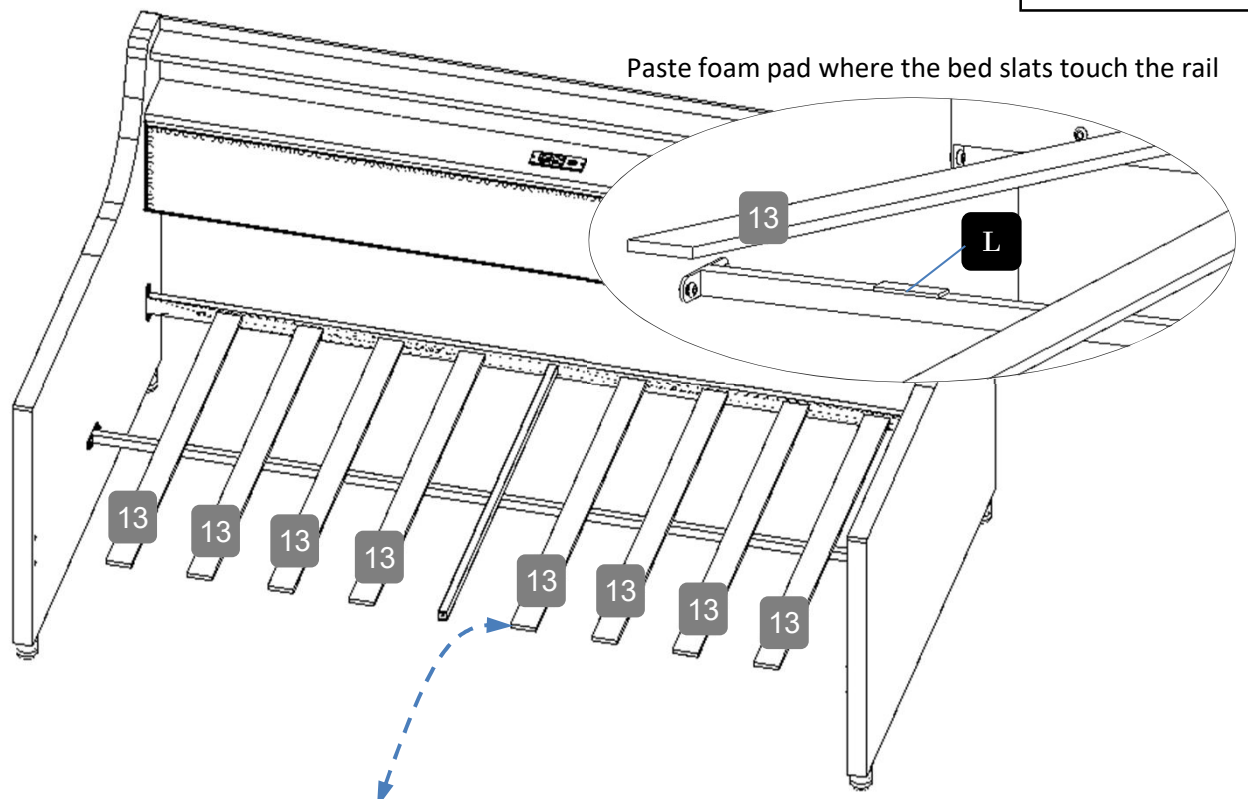

Paste foam pad where the bed slats touch the rail

Please note that the bottom of these 8 slats is without felt, and the bottom of the other 8 slats with felt is used in step 14 of the installation diagram

Step9

B



Bolts(M6X16mm) X5

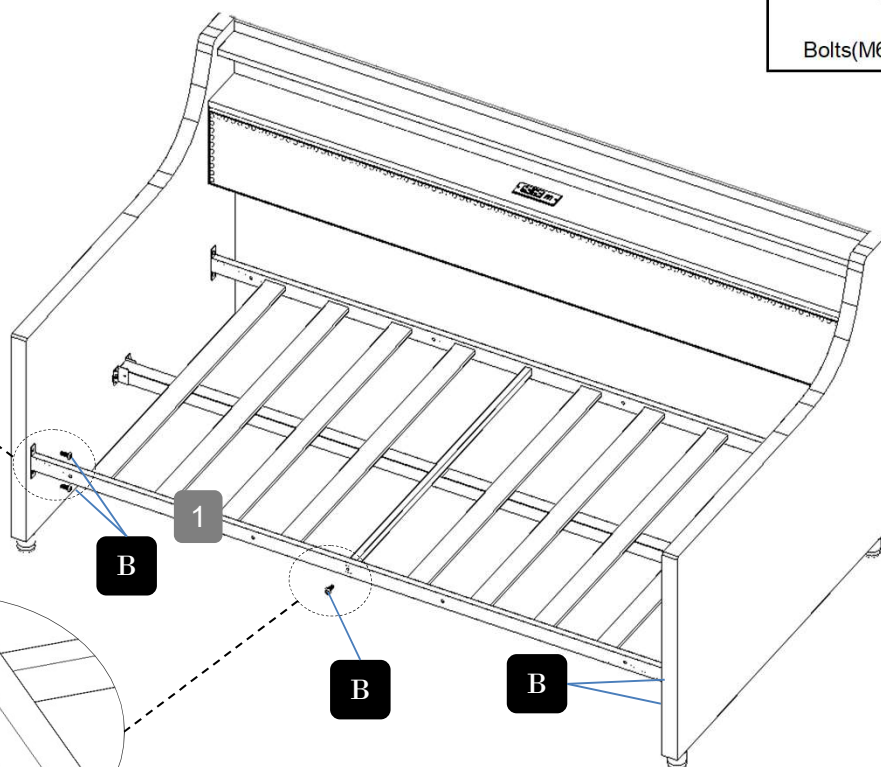
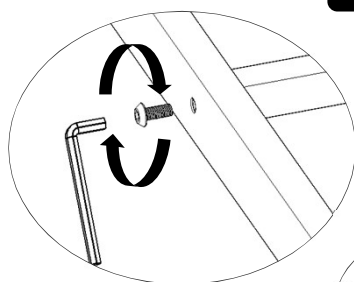
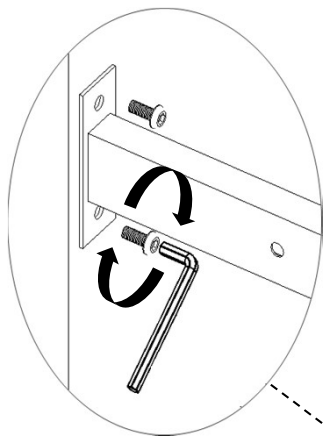

Note the installation direction of metal slat frame NO.1

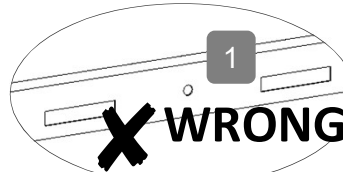
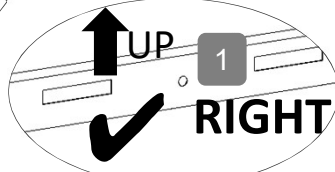

Step10

C



Bolts(M6X30mm) X8

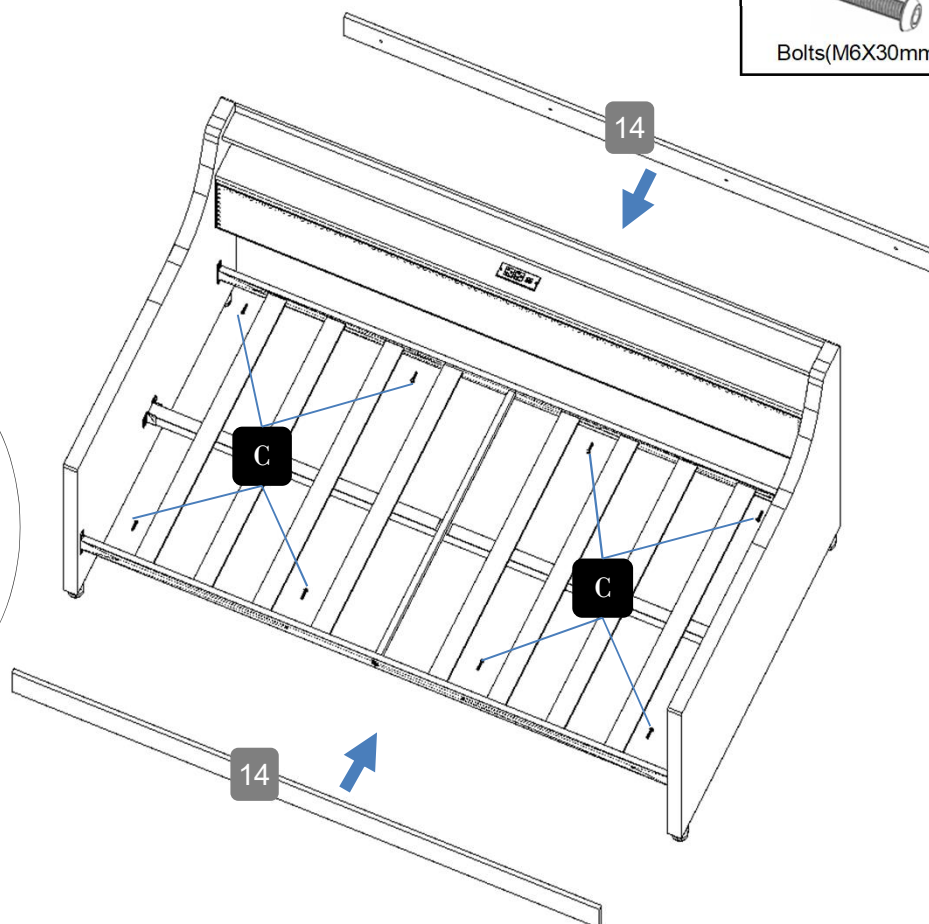
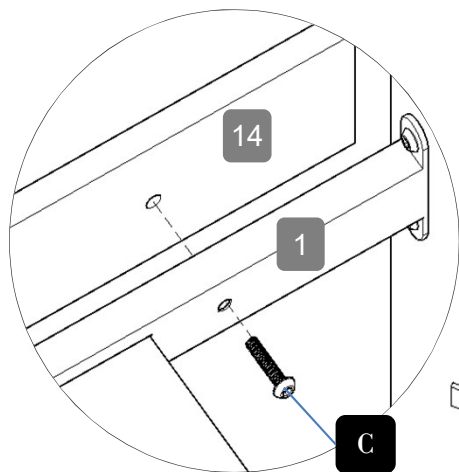

After this step, you can lock the other bolts tightly
Page 8 of 11

Step11

D



Bolts(M6X35mm) X12

H



Flat Gasket X12

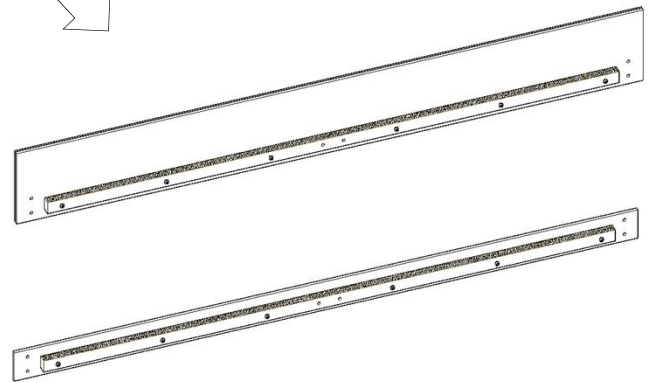
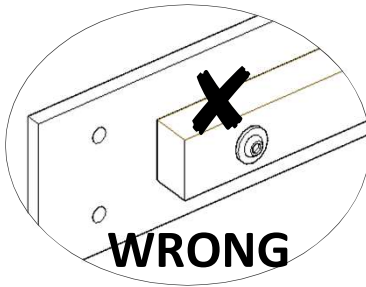
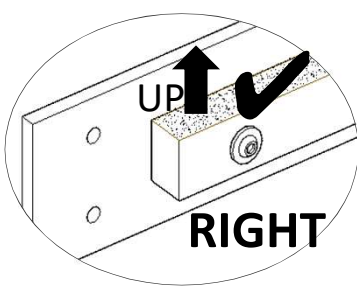
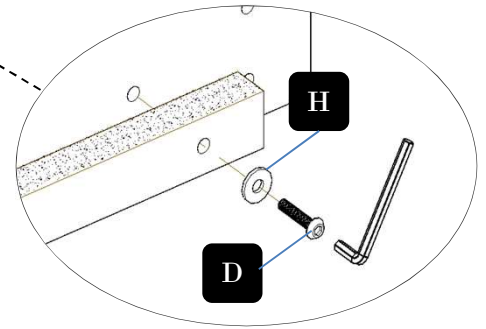
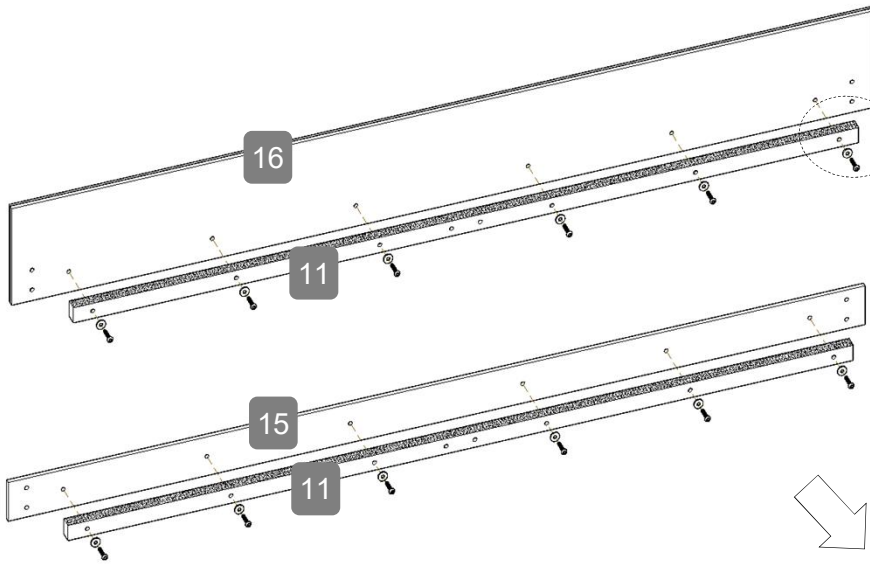

Step12

A



Bolts(M6X10mm) X8

B



Bolts(M6X16mm) X4

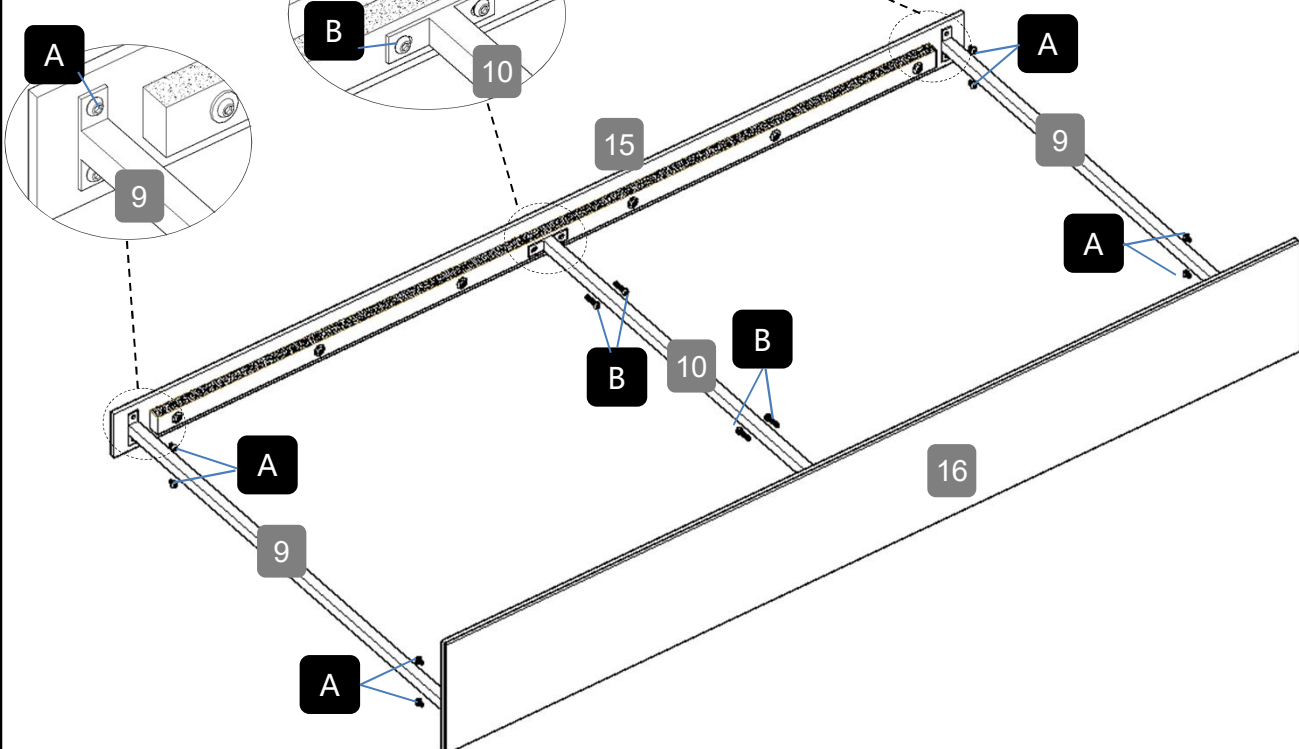
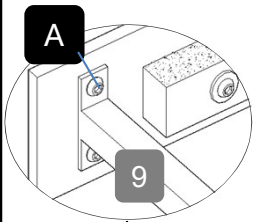
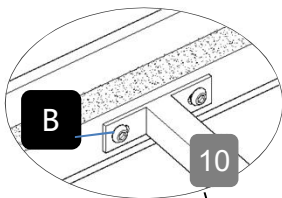
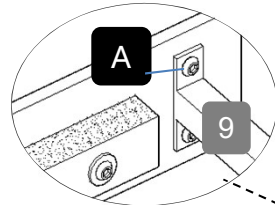

Step13

Tip: You can press and hold the brake of part18 to keep the bed in place

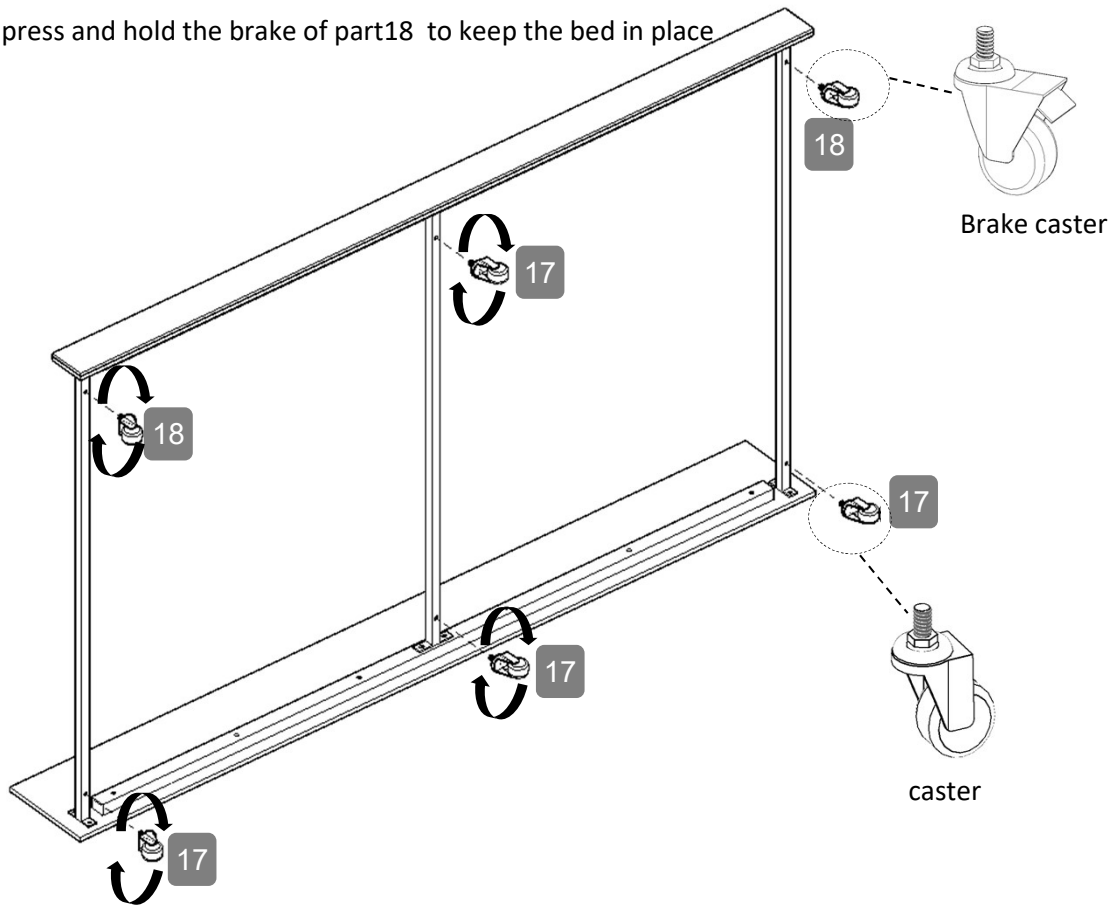

Step14

Please note that these 8 slats have felt on the bottom

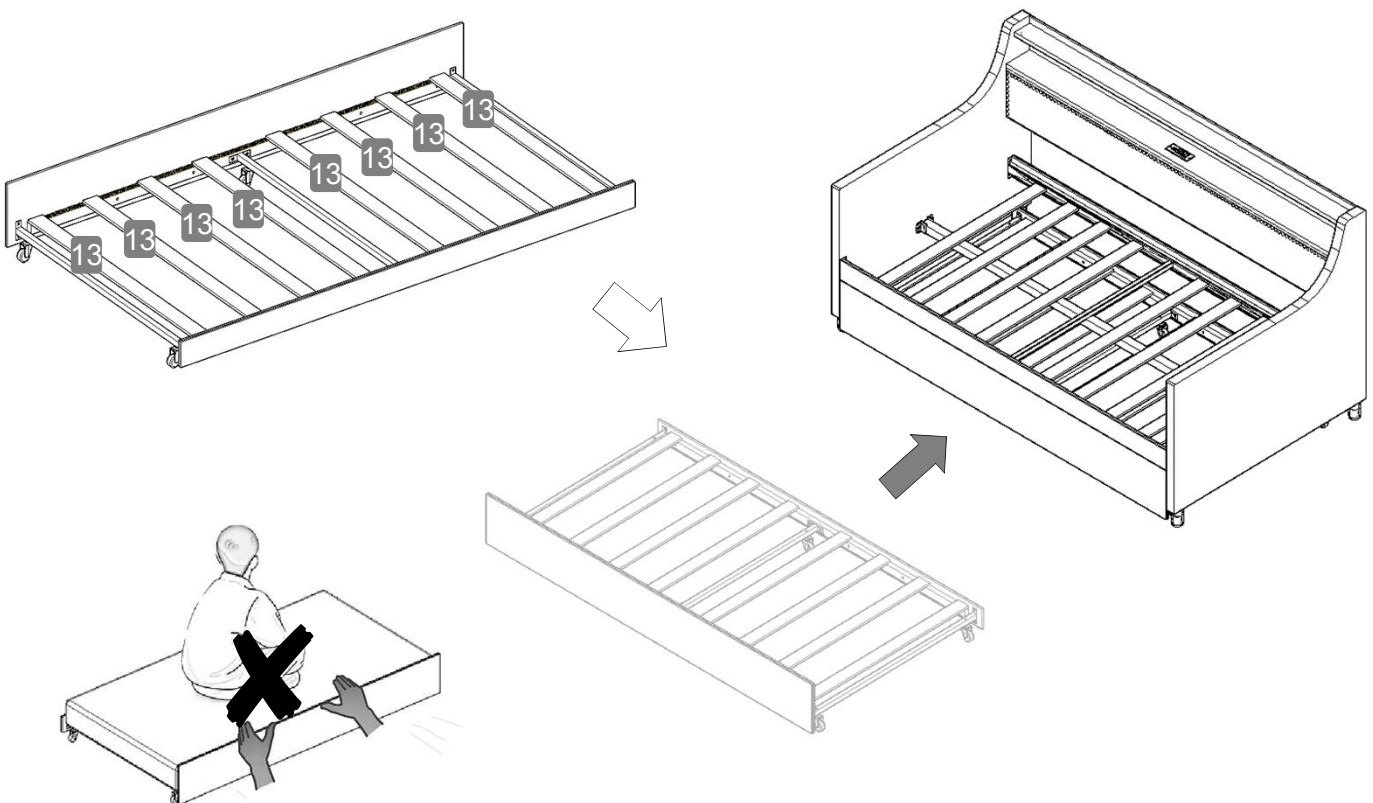

Note: Please don't move the bed when someone is in it

Step15

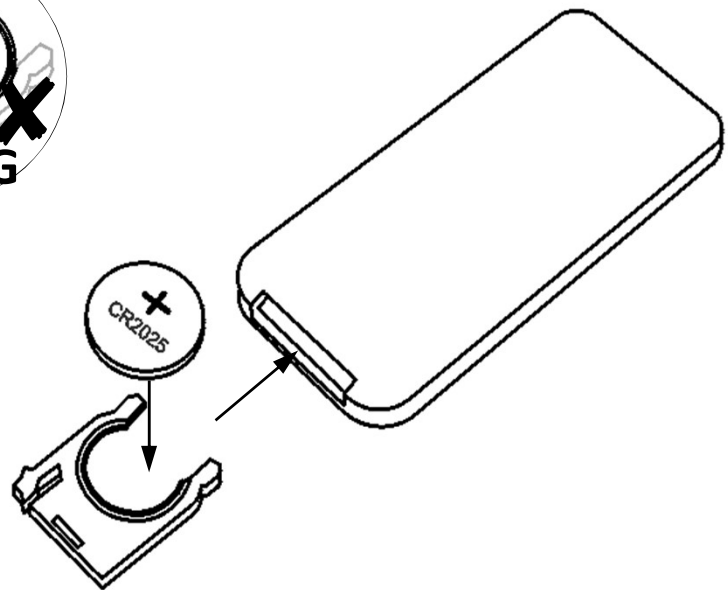
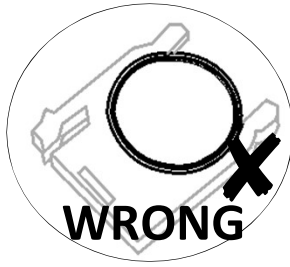
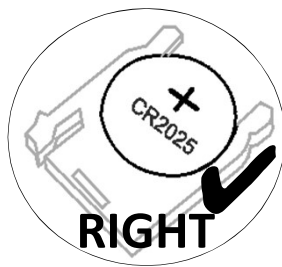

Remote control does not contain batteries, please buy your own a CR2025 button battery installed into the remote control