

# ASSEMBLY INSTRUCTIONS

## TWIN

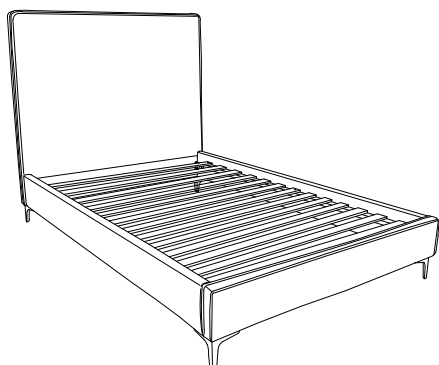

### + Do Not Use Power Tools



### + Suggested Adults

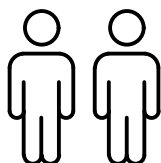

#### NOTE:

- 1 Read instructions cover to cover.
- 2 Save all packaging until assembly is completed.

### 1 IMPORTANT SAFETY INFORMATION

**Do not** assemble the product if any of the following parts arrived damaged:

1. Headboard Panel
2. Footboard Panel
3. Side Rail
4. Gold Leg
5. Silver Leg
6. Slats(13pcs)

### 2 IMPORTANT ASSEMBLY INFORMATION

**Assembly Step** Ensure the side rail bracket is fully hooked onto bolt loosely threaded with both washers on the OUTSIDE of the bracket first, then proceed to fully tightening all 4 corners.

### + Parts Included

① Headboard Panel  
(1 pc)

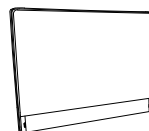

② Footboard Panel  
(1 pc)

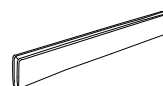

③ Side Rail  
(2 pcs)

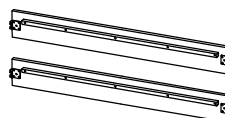

④ Gold Leg  
(4 pcs)



⑤ Silver Leg  
(4 pcs)



⑥ Slats(13pcs)  
(1 pc)



### + Hardware Included

A Allen Key M4  
(1 pc)



B Allen Key M5  
(1 pc)



C JCBB Bolt  
M8 x 16mm  
(8 pcs)



D JCBC Bolt  
M6 x 25mm  
(8 pcs)



E CBS Screw  
M4 x 25mm  
(24 pcs)



F CBS Screw  
M4 x 32mm  
(6 pcs)



# ASSEMBLY INSTRUCTIONS

## TWIN

**1**

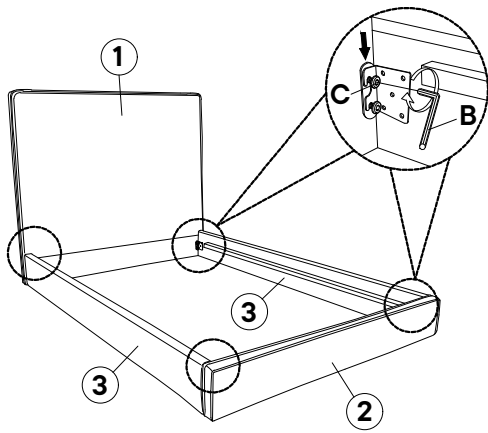

**2**

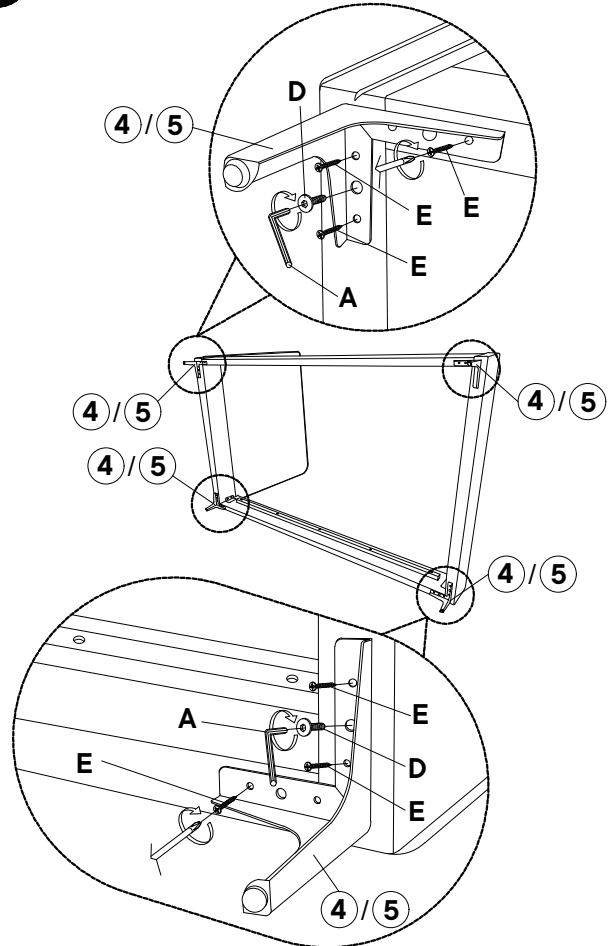

**3**

