

## ASSEMBLY INSTRUCTION

# SOLAR FROG YARDSTAKE

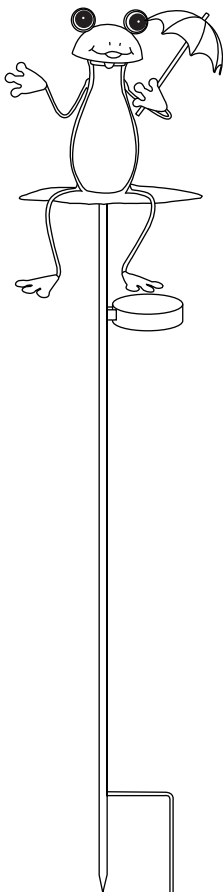

Please carefully unpack and identify each component before beginning assembly. Before you begin, please refer to parts list to make sure that you have all parts. Please take care when assembling the unit and always place the parts on a clean, soft surface. If you require assistance with assembly or parts, please call 888-357-7263.

Get social with us and discover more about our products, tips and exclusive discounts!





## HOW THE SOLAR LIGHT WORKS

During the day, the solar panel converts solar power into energy and stores it in the rechargeable battery. At night, the light turns on automatically and using the energy stored. The duration of the illumination will depend on your geographical location, weather conditions and seasonal light availability.

## CHOOSE AN IDEAL LOCATION

Choose an outdoor location where the solar panel can receive at least 6 hours of full and direct sunlight each day. Shaded locations will reduce the battery charge and shorten the illumination time at night. Avoid placing solar lights near bright light sources, such as street lights. The bright light sources may cause the solar light to turn off automatically. Solar lights are ideal for night time lighting in the garden, lawn, etc. You can also place the solar lights outdoor during the day and then place them indoors for lighting.

## ATTENTION FOR FIRST TIME USE

1. Turn the AUTO/OFF switch to the "ON" position, the light sensor will control the lighting automatically. When the environment turns dark, the solar light will turn on and use the energy stored in the battery.
2. If the solar light does not turn on automatically at night after 6 hours of charging during the day, please check the following:

- 1) Make sure the power switch is at the "ON" position.
- 2) Check the battery and make sure the battery contacts the terminals securely.
- 3) Make sure the solar light is located in a sunny location and the solar panel can receive direct sunlight.

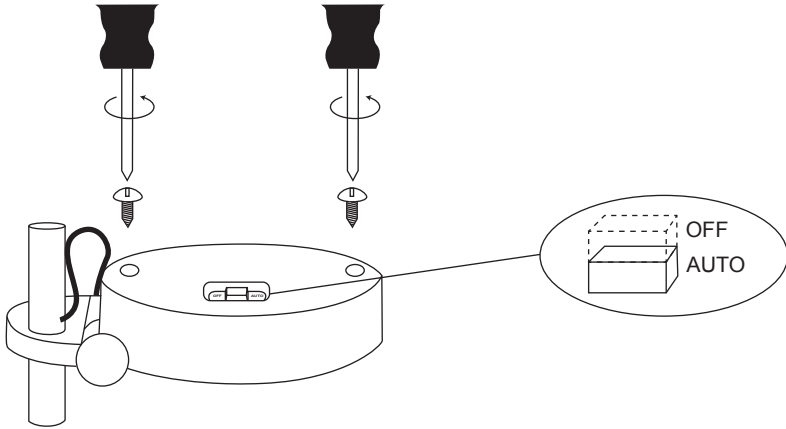

## PRECAUTIONS

1. Please note the solar light is designed to work when the environment gets dark. If there are strong light sources nearby, the solar light may illuminate dimly or not light up at all.
2. Although the battery has been charged by the manufacturer, the electric charge may have dropped by the time consumer receives the product. Please let the solar light charge for a full day for the maximum performance.
3. Surface of the solar panel must be kept clean. Dusty surface will reduce charging efficiency.

## PARTS LIST

(A)

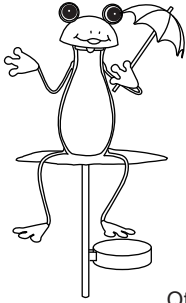

Qty: 3

(B)

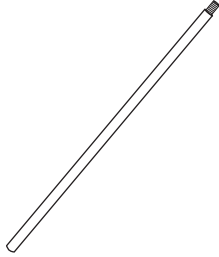

Qty: 3

(C)

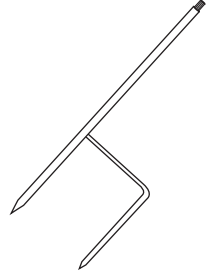

Qty: 3

## ASSEMBLY INSTRUCTION

PLEASE CAREFULLY UNPACK AND IDENTIFY EACH COMPONENT BEFORE BEGINNING ASSEMBLY. BEFORE DISCARDING THE PACKAGING, PLEASE DOUBLE-CHECK THE CONTENTS TO ENSURE YOU HAVEN'T ACCIDENTALLY DISCARDED ANY PARTS NECESSARY FOR ASSEMBLY.



A



B



C

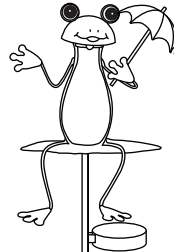

## REPLACE BATTERIES

The solar light includes 1pc 1.2V AAA 300MAH, Ni-MH rechargeable batteries.

If the solar light stops working after extended use, it may be due to a depleted battery. To resolve this issue, follow these steps:

**Step1:** Unscrew the battery compartment cover by using a Phillips head screwdriver (not included). The battery compartment is located underneath the solar panel.

**Step2:** Remove the exhausted battery and install 1pc 1.2V AAA 300MAH, Ni-MH rechargeable batteries according to the +/- polarity.

**Notes:**

1. Make sure to use batteries of the recommended equivalent type.
2. Open the compartment carefully and ensure that the welding wires inside the battery terminals are not damaged.

**Step3:** Replace battery compartment cover, screw it back into position and make sure is properly sealed.

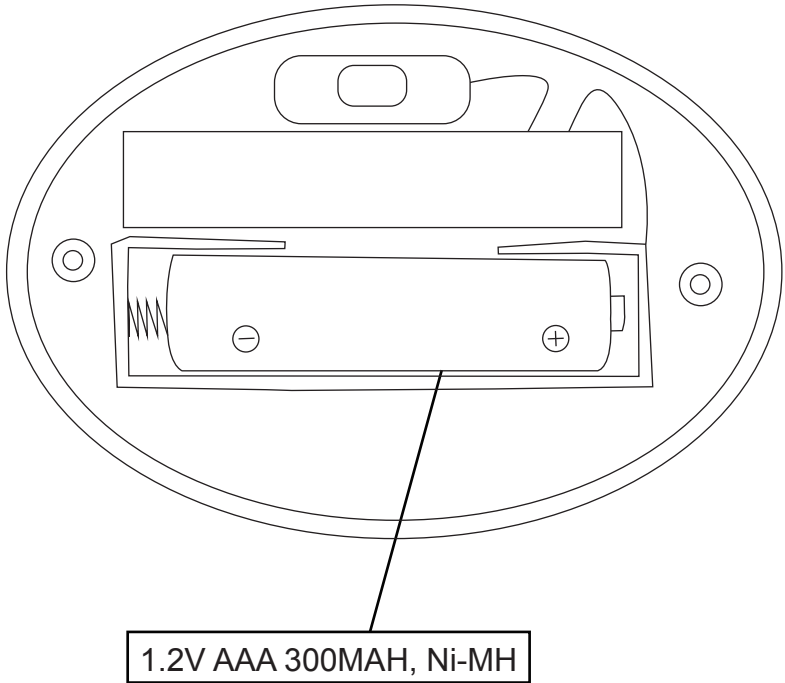

## **⚠ WARNING**

1. Keep batteries away from children. This product is not a toy.
2. Ensure battery contacts are clean and free of debris.
3. Install batteries according to correct polarity (+/-).
4. Remove batteries when consumed or when product is not in use for an extended period of time.
5. Contains Ni-MH battery. Batteries must be recycled or disposed of properly, in accordance with all state and local regulations. DO NOT crush, puncture, or incinerate.

glitzhome<sup>®</sup>

---

**Glitzhome ,LLC.**

Toll free 888-357-7263

[customerservice@glitzhome.com](mailto:customerservice@glitzhome.com)