

Features

- Integral flange.
- Right offset drain.
- Removable drain cover.
- Complements traditional and contemporary bathroom designs.
- 60" (1524 mm) x 34" (864 mm) x 4" (102 mm)

Material

- Cast iron with Safeguard® finish.

Installation

- Alcove

Required Accessories

K-9157 Drain Cover

or

K-9159 Drain Cover

Recommended Accessories

K-9132 Shower Drain



Codes/Standards

ASME A112.19.1/CSA B45.2







ASTM F462

KOHLER® Enameled Cast Iron Bath and Shower Base Lifetime Limited Warranty

See website for detailed warranty information.

Available Color/Finishes

Color tiles intended for reference only.

Color	Code	Description
	0	White
	96	Biscuit
	47	Almond
	NY	Dune
	95	Ice™ Grey
	G9	Sandbar

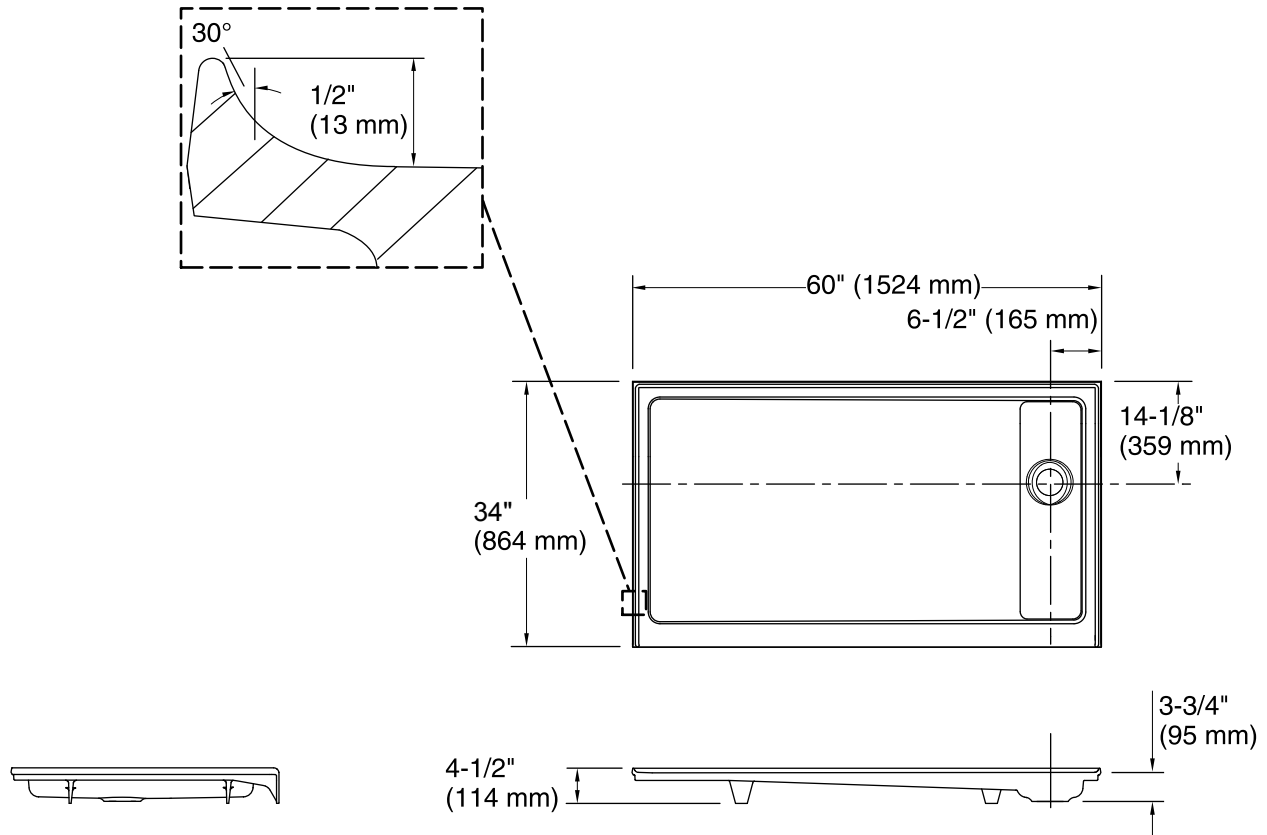

Technical Information

All product dimensions are nominal.

Installation: 3-Wall Alcove

Drain location: Right

Weight: 193 lbs (87.5 kg)

Notes

Measure your actual product for rough-in details.

Install this product according to the installation instructions.

The dimensions are applicable for this product only and should not be used to fabricate substitute bases for shower enclosures.

KOHLER steam generator/control kit is designed for use with this product. Kohler Co. shall not be responsible for problems encountered due to the installation and use of other manufacturer's steam generators.