

**EN - 2 boxes in total, This is 2/2 box.**



**DE - Insgesamt 2 Pakete, Das ist 2/2 Paket.**

**ES - 2 cajas en total, Esto es 2/2 caja.**

**FR - 2 boîtes au total, Il s'agit de 2/2 box.**

**IT - 2 scatole in totale, Questa è una scatola da 2/2.**

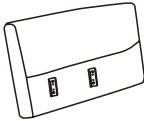
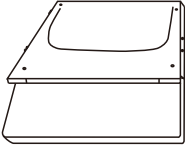
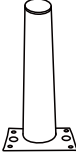
# Parts List of Box 2/2

<p>① × 1                      L</p> 	<p>③ × 1                      L</p> 	<p>⑤ × 1</p> 
<p>⑥ × 2</p> 		

# Parts List of Box 2/2

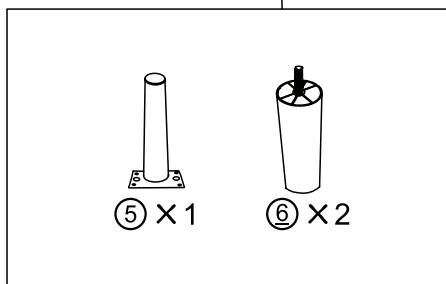
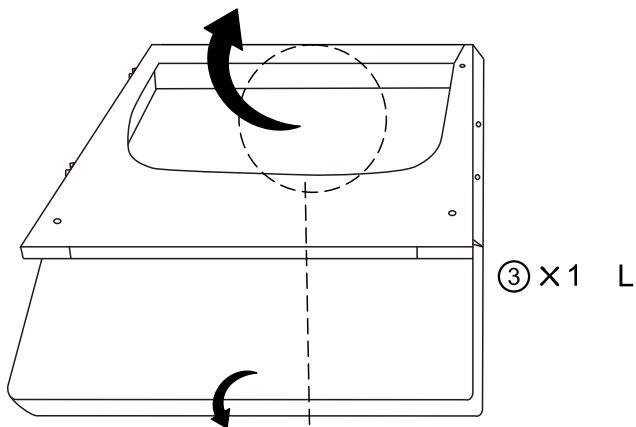
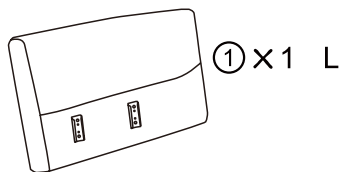

- EN** - Remove all parts from the storage compartment located at the back of the sofa backrest or bottom of the seat prior to assembly.
- DE** - Vor dem Aufbau nehmen Sie alle Zubehörteile aus dem Staufach, das sich an der Rückseite der Rückenlehne oder an der Unterseite des Sitzes befindet.
- ES** - Retire todas las piezas del compartimiento de almacenamiento ubicado en la parte posterior del respaldo del sofá o en la parte inferior del asiento antes del ensamblaje.
- FR** - Avant l'installation du produit, veuillez retirer le kit d'accessoires des compartiments derrière le dossier ou en bas d'assise.
- IT** - Si prega di rimuovere tutte le parti dal vano portaoggetti situato sul retro dello schienale del divano o sul fondo della seduta prima del montaggio .