

# ELECTRIC FIREPLACE

## IMPORTANT INSTRUCTIONS & OPERATING MANUAL

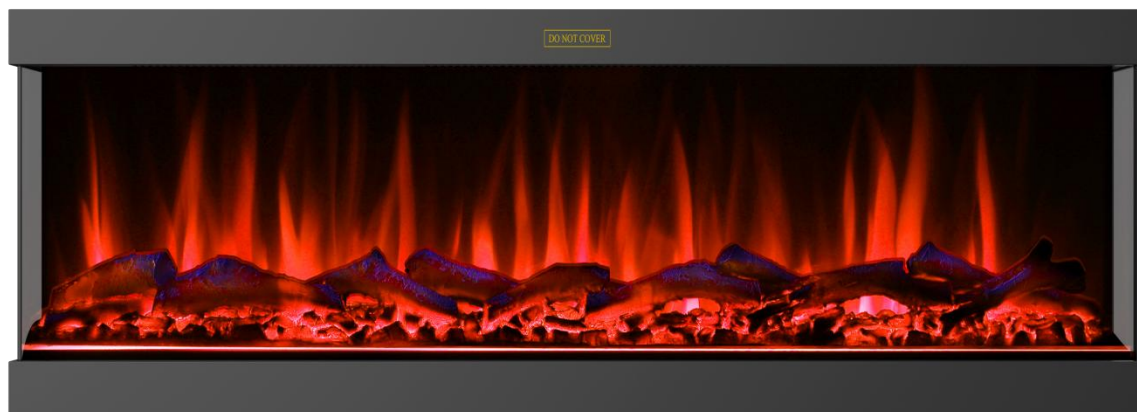

<b>WARNING</b>	Read and understand this entire owner's manual, including all safety information, before plugging in or using this product. Failure to do so could result in fire, electric shock, or serious personal injury.
<b>CAUTION</b>	Keep this owner's manual for future reference. If you sell or give this product away, make sure this manual accompanies this product.

## Safety information

- If equipped with a heater, this appliance can be hot when operated and can cause severe burns if contacted.
- Do not operate appliance before reading and understanding operating instructions. Failure to operate appliance according to operating instructions could cause fire or injury.
- Do not install damaged, incomplete or substitute components.
- Do not burn wood or other materials in this appliance.
- All electric appliances have hot and arcing or sparking parts inside. Do not use it in areas where have gas line, paint or flammable liquids.
- Any safety screen or guard removed for servicing must be replaced prior to operating the appliance.
- It is imperative that the control compartments, circulating blower and its passageway in the appliance are kept clean. The appliance should be inspected before use and at least annually by a qualified service person. More frequent cleaning may be required due to excessive lint from carpeting, bedding material, etc. The appliance area must be kept clear and free from combustible materials, gasoline and other flammable vapors and liquids.
- Under no circumstances should this appliance be modified.
- Do not use this appliance if any part has been under water. Immediately call a qualified service technician to inspect the appliance and to replace any part of the control system which has been under water.
- If equipped with a glass door, do not operate the appliance with the glass door removed, cracked or broken. Replacement of the glass should be done by a licensed or qualified service person. Do not strike or slam shut the appliance glass door.
- Keep the packaging material out of reach of children and dispose of the material in a safe manner. As with all plastic bags, these are not toys and should be kept away from children and infants.
- Servicing should be done only while the appliance is disconnected from the power supply circuit.
- Always unplug appliance when not in use.
- Do not operate this appliance with a damaged cord or plug after the appliance malfunctions, has been dropped or damaged in any manner. Return appliance to authorized service facility for examination, electrical or mechanical adjustment, or repair.
- Do not use outdoors.
- When installing this appliance in a room where water is present, the installation must comply with codes recognizing the increased hazard of electrical shock and electrocution.
- Do not run cord under carpeting. Do not cover cord with throw rugs, runners, or the like. Arrange cord away from traffic area and where it will not be tripped over.
- Connect to properly grounded outlets only.
- Do not insert or allow foreign objects to enter any ventilation or exhaust opening as this may cause an electric shock or fire, or damage the appliance.
- It is normal for your electric appliance to produce noise, especially when installed in a quiet space such.
- To prevent a possible fire, do not block air intakes or exhaust in any manner. Do not use on soft surfaces, like a carpet, where openings may become blocked.
- Always plug appliances directly into a wall outlet/receptacle. Never use an extension cord or relocatable power tap (outlet/power strip).
- These appliances are tested and listed for use only with the optional accessories listed in these instructions. Use of optional accessories not specifically tested for this appliance could void the warranty and/or result in a safety hazard.



- Do not cover. In order to avoid overheating.

## For appliances equipped with a heater:





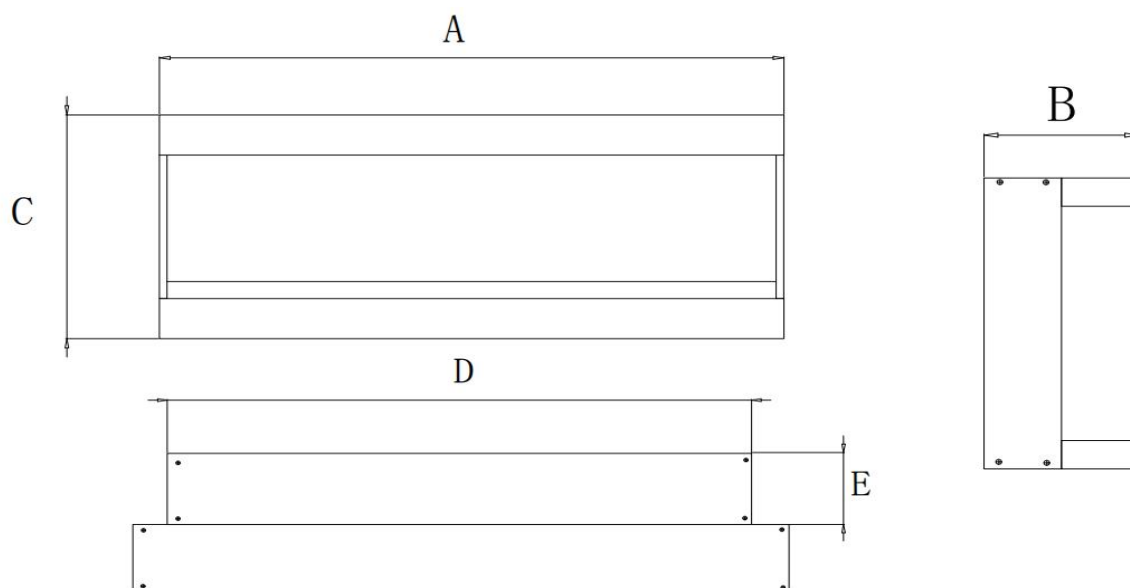

- Risk of burns. Power to the appliance should be turned off and the appliance allowed to cool before servicing. To disconnect power to the appliance, turn controls to off, then remove plug from outlet.
- Young children should be carefully supervised when they are in the same room as the appliance. Toddlers, young children and others may be susceptible to accidental contact burns. A physical barrier is recommended if there are at risk individuals in the house. To restrict access to an appliance or stove, install an adjustable safety gate to keep toddlers, young children and other at risk individuals out of the room and away from hot surfaces.
- Clothing or other flammable material should not be placed on or near the appliance.
- Due to high temperatures, the appliance should be located out of traffic and away from furniture and draperies.
- Ensure you have incorporated adequate safety measure to protect infants/toddlers from touching hot surfaces.
- Even after the appliance is off, the glass and/or screen will remain hot for an extended period of time.
- Check with your local hearth specialty dealer for safety screens and hearth guards to protect children from hot surfaces. These screens and guards must be fastened to the floor.
- Ensure clearances to combustibles are maintained when building a mantel or shelves above the appliance. Elevated temperatures on the wall or in the air above the appliance can cause melting, discolor or damage to decorations, a TV or other electronic components.

## Dimensions

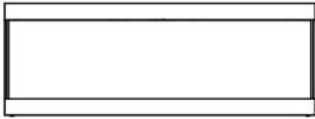

MEDEL NUMBER	A (mm)	B (mm)	C (mm)	D (mm)	E (mm)
CSF-36C	914	245	380	855	125
CSF-42C	1065	245	380	1005	125
CSF-50C	1218	245	380	1160	125
CSF-60C	1422	245	380	1360	125
CSF-72C	1826	245	380	1765	125

## Hardware parts list

Name	Picture	Qty
Heater		1
Remote Control		1
4×10mm Metal Screws		8
4*35mm self tapping screw		4
8 x 40mm plastic expansion tube		4
Log		1
Fixed bottom bracket		4

### Helpful Advice before Fitting

- Please retain all packaging until you have checked and counted all the parts and the contents of the hardware pack against the parts list.
- The hardware pack contains small items which should be kept away from young children
- We suggest that you open the hardware pack and place all the contents into a container, therefore reducing the risk of losing any small pieces.

# Installation

## 1 .Embedded in the simulation chimney

Step 1 .According to the information in the table, reserve the corresponding size of the chimney and reserve the socket at the top right of the hole.(pictured)

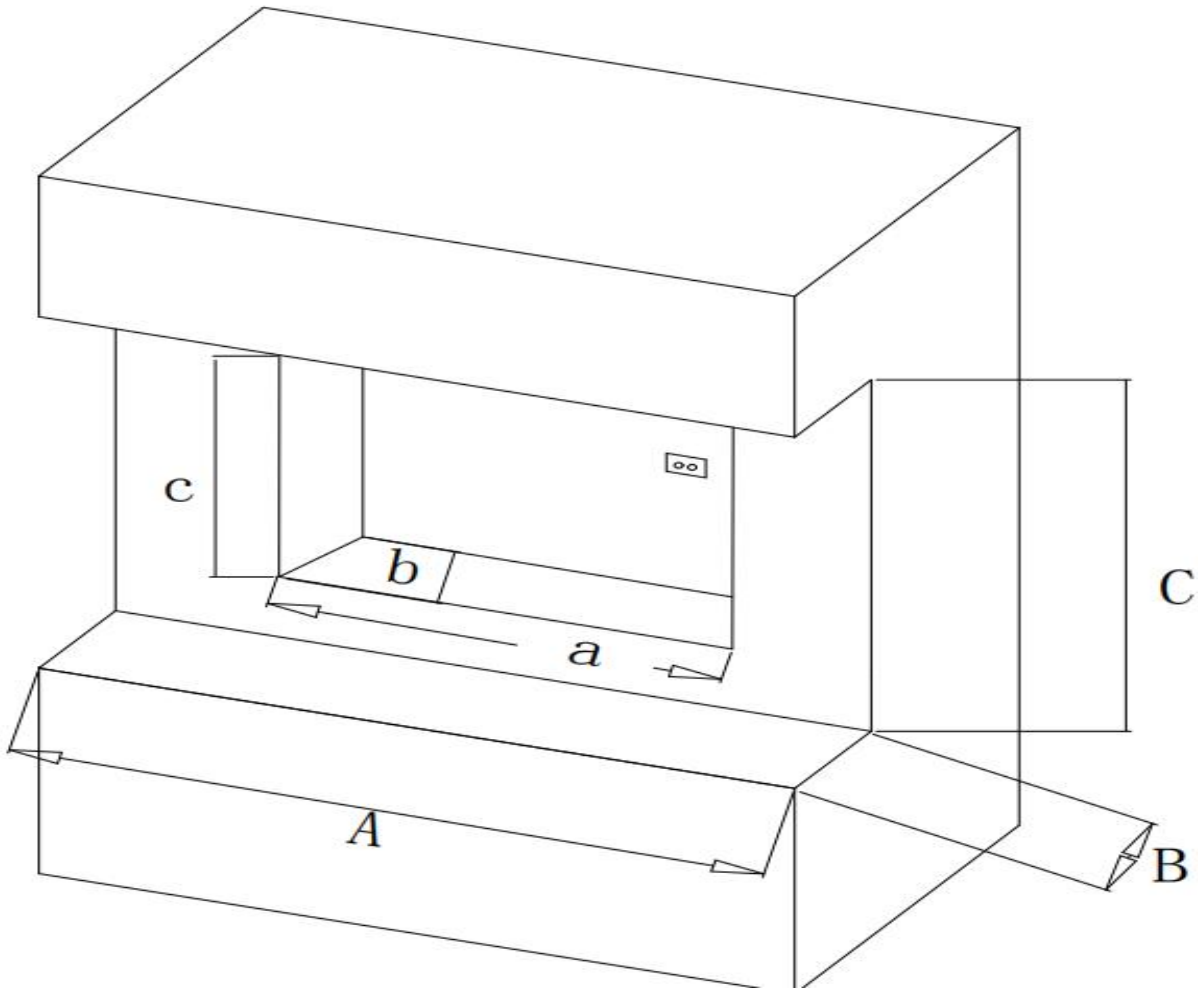

MODEL NUMBER	A (mm)	B (mm)	C (mm)	a (mm)	b (mm)	c (mm)
CSF-36C	914	120	395	875	145	395
CSF-42C	1065	120	395	1025	145	395
CSF-50C	1218	120	395	1180	145	395
CSF-60C	1422	120	395	1380	145	395
CSF-70C	1826	120	395	1785	145	395

Step 2 . Fix the fixing bracket in the accessory bag to the bottom of the product with 4 screws of 4\*10mm (pictured 1).



pictured 1

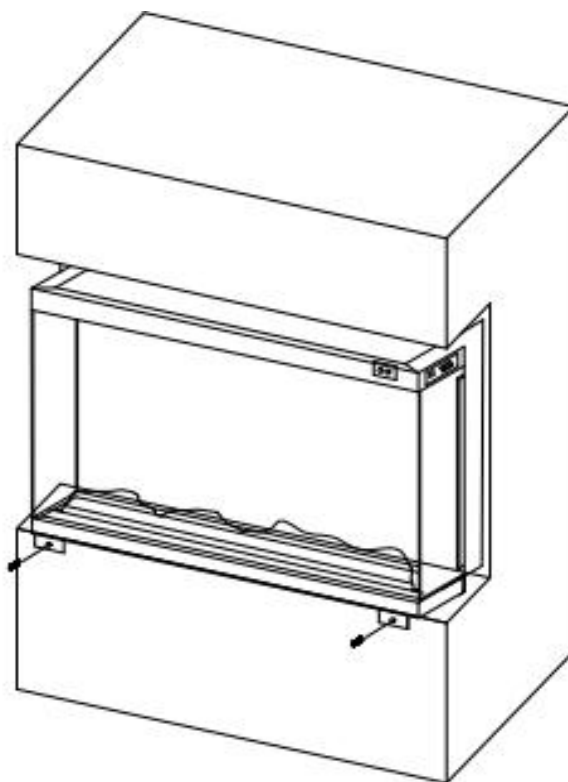

pictured 2

Step 3. Install the fireplace in the chimney and secure it with two 4\*35mm screws and an 8\*40mm expansion tube(pictured 2).

## 2 .The insert is mounted on the wall

Step 1 .According to the information in the table, reserve the size of the corresponding model on the wall, and reserve the socket in the upper right corner.

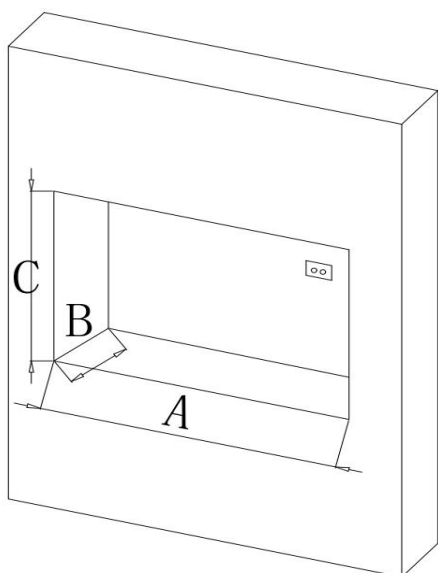

MODEL NUMBER	A (mm)	B (mm)	C (mm)
CSF-36C	875	160	390
CSF-42C	1025	160	390
CSF-50C	1180	160	390
CSF-60C	1380	160	390
CSF-70C	1785	160	390

Step2. Install the fixing brackets in the accessory package on both sides of the fireplace with 4\*10MM screws (pictured 3).

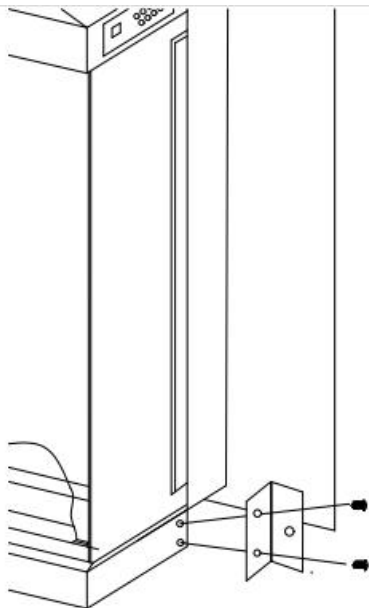

pictured 3

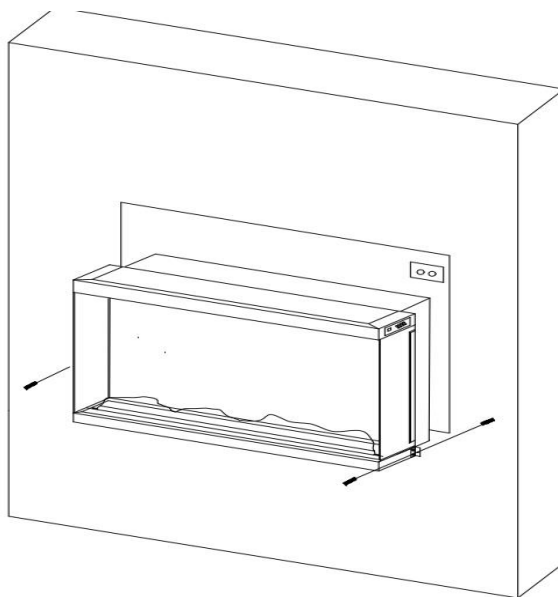

pictured 4

Step3. Place the fireplace inside the wall and secure it with 4\*35MM screws and 8\*40mm expansion tubes (pictured 4)

### Control Panel / Remote Control Operation

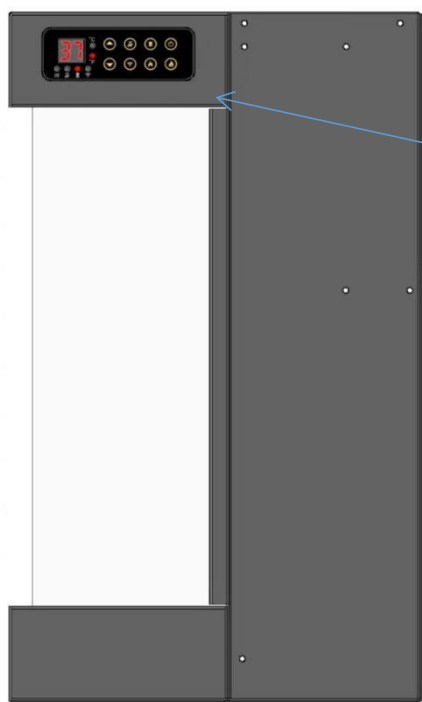



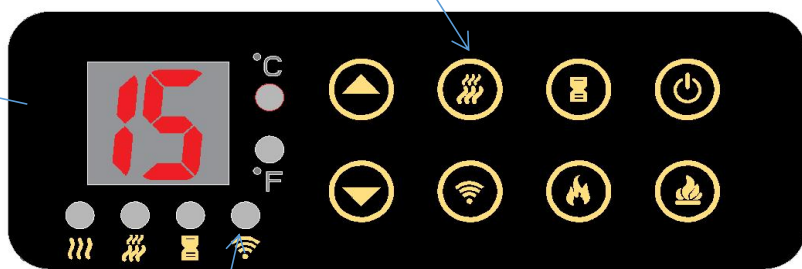



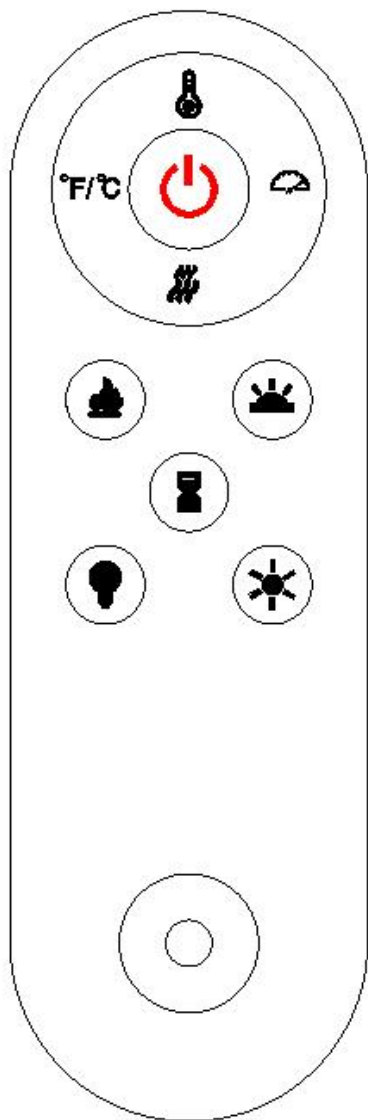



Remote control learning key



WIFI indicator



	ON/OFF	Turns appliance on and off.
	Flame Colour	Controls Log Flame change. 9 colors: ( F0-F1-F2-F3-F4-F5-F6-F7-F8-F9) F0 is the color loop file
	Flame brightness	Controls Flame brightness. 5 Settings:( L5-L4-L3-L2-L1) Flame dims from L5 to L1. L5 is the brightest setting(In Flame mode F0, the light brightness is maximum by default.)
	Ember Bed Colour	Controls Ember Bed change. 7 colors: ( C0-C1-C2-C3-C4-C5-C6-C7) C0 is the color loop file
	Heating power	Controls the Heater. Press button to initiate the heater. (OF): no heater or blower. (LO): heater blows warm air 900W) (HI):heater blows hot air (1800W) <b>When the setting temperature is less than room temperature, the heating wire is not opened.</b>
	Timer	Controls the Timer. 24 Settings:(1h-24h) Press button until reach desired setting.
	Temperature Set	Controls the Temperature. 15°C(59° F)~35°C(95° F).
	Ember Bed Brightness	Controls Ember Bed brightness. 5 Settings:(-5,-4,-3,-2,-1) Flame dims from -5 to -1. -5 is the brightest setting(In carbon bed mode C0, the light brightness is the brightest by default.)
	Flame Speed	Controls Flame Speed. 4 Settings:(1-2-3-4) Flame Speed
	WIFI Reset	Press and hold for 3 seconds to reset WIFI

•In the standby mode, long press the remote control learning key on the control panel, the indicator will blink, press any key on the remote control, the remote control is paired successfully.

## Connection by WIFI

1. Use your phone to scan the QR code below or search “Tuya Smart” in Application on market to download and install the App.
2. Select your country code, enter the cellphone number and tap “Get” to get a message containing verification on code.
3. Enter the verification on code in the message and tap “Login” to login the App.
4. Switch on the product and make sure the product is in WIFI covered environment. The WIFI indicator light will rapidly blinks. If the indicator light do no rapidly blinks, please press “” button for 5 seconds ,then go to the App, tap “add device” at the bottom, as shown in the picture 1,

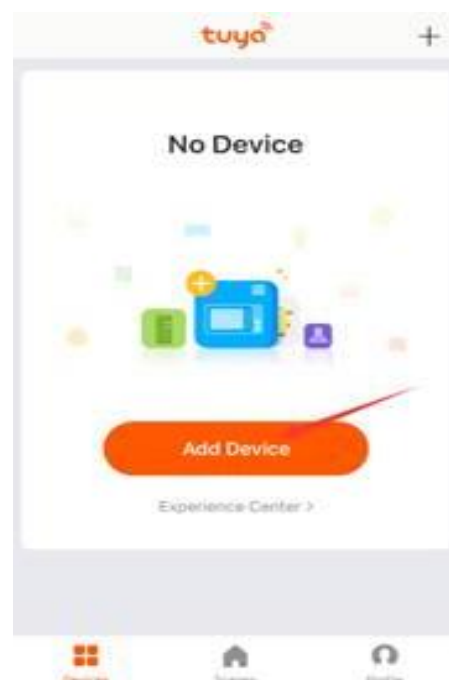

**Pic 1**

- A) Choose “Heater”,as shown in pic 2
- B) Press the “confirm indicator rapidly blinks” when the indicating light on device rapidly blinks,as shown in pic 3
- C) Input password of WIFI and then confirm,as shown in pic 4
- D) Wait for the APP to connect with the device until it is connected succesfully .as shown in pic 5



**Pic 2**

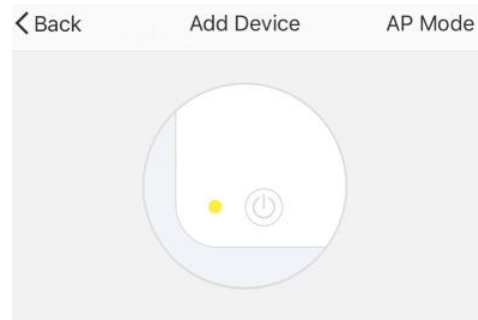

Power on the device and confirm that indicator light rapidly blinks

[How to make indicator rapidly blink](#)

Confirm indicator rapidly blink

**Pic 3**

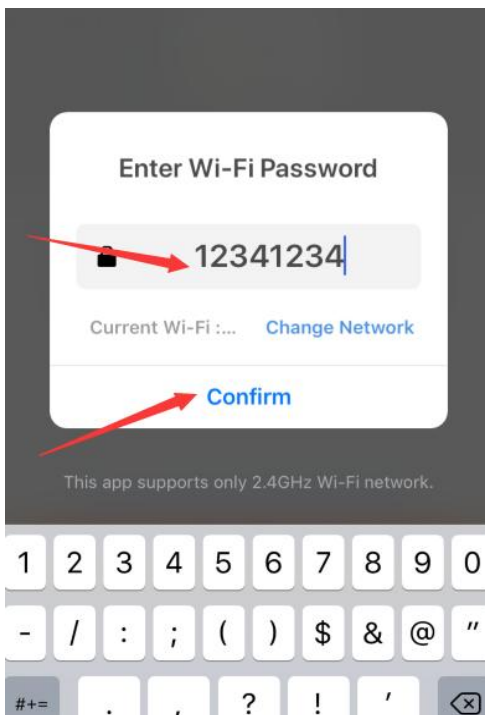

**Pic 4**

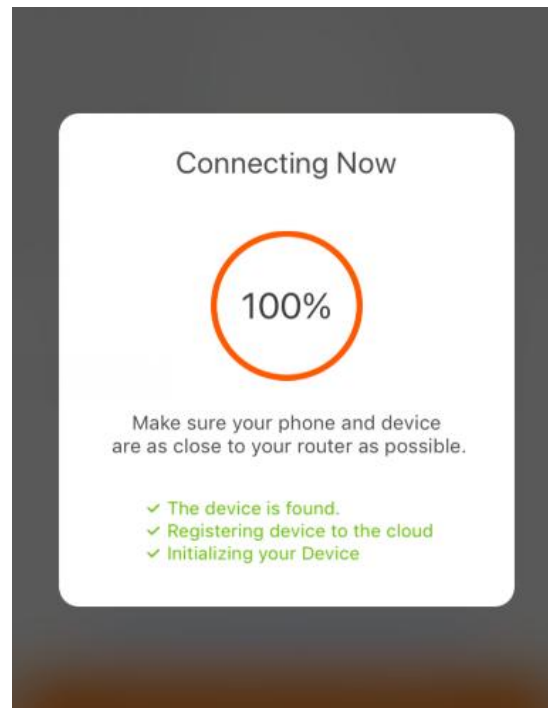

**Pic 5**

1. You can operate the device by mobile under WIFI or 4G LTE environment, Enter the main interface of the device and you will see the power supply, mode, timer and Settings as shown in the picture 6,
2. Press the power button, and you can use your heater on the APP. Turn on the mode, and you can choose the right temperature ,as shown in pic 7.
3. Press the timer, you can choose in 1~8 hours,as shown in pic 8.



**Pic 6**

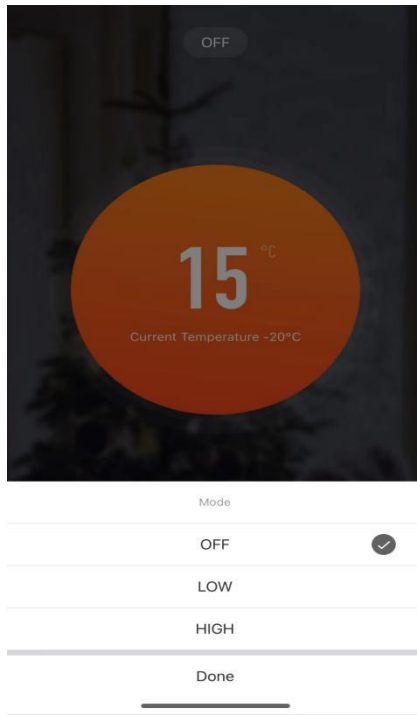

**Pic 7**

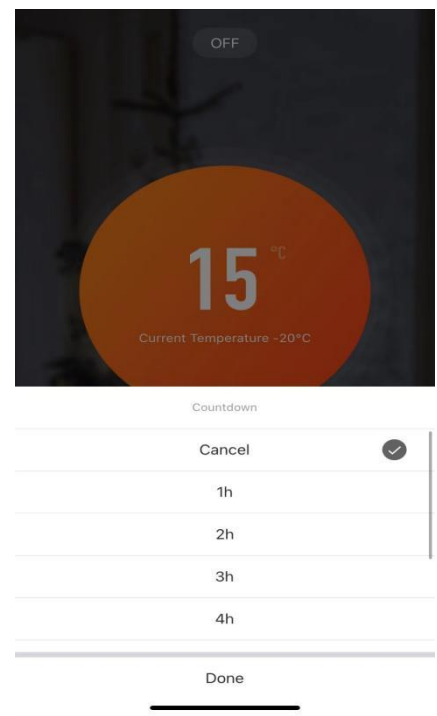

**Pic 8**

4. Press the setting button to enter "Weekly plan", "Flame Color Adjustment", "Charcoal color Adjustment", "Ember Bed Brightness", "Flame brightness", and "Speed adjustment", as shown in pic 9.

5. Entering the Week Program, you can choose the appropriate temperature for 24 hours in any day of the Week, as shown in pic 10.

6. Open the flame color selection, you can choose a total of 7 colors F0~F9. in pic 11.

7. Open the charcoal color selection, you can choose a total of 10 colors C0~C7. in pic 12.

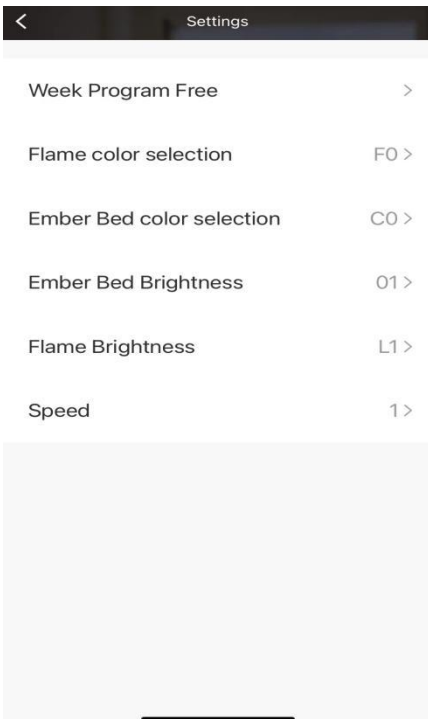

**Pic 9**

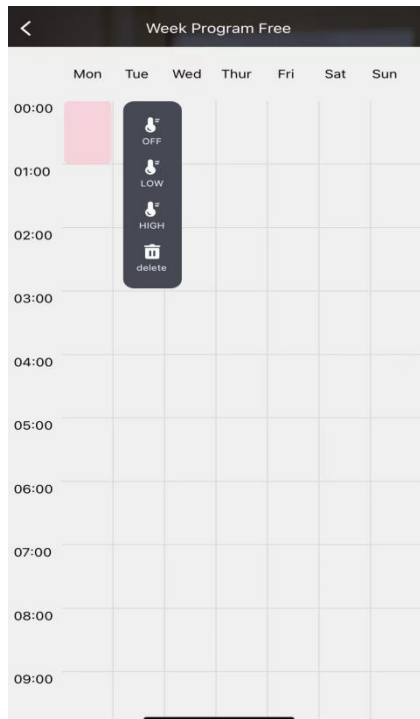

**Pic 10**

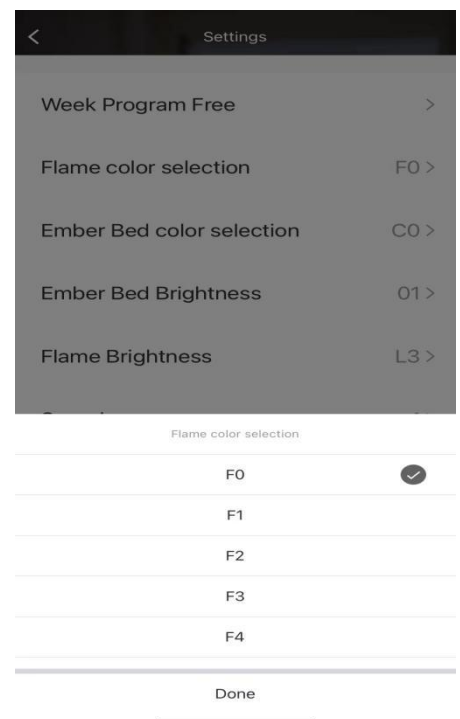

**Pic 11**

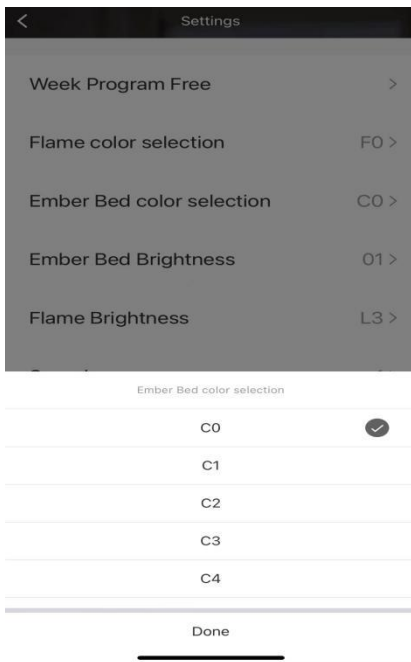

**Pic 12**

## Operation

Plug the power cord into a 220-240 Volt 15 Amp outlet. Make sure the outlet is in good condition and that the plug is not loose. NEVER exceed the maximum amperage for the circuit. DO NOT plug other appliances into the same circuit.

### Cleaning:

- Turn heater OFF and unplug from electrical outlet before any cleaning or maintenance is performed. Wait at least 10 minutes to allow all components to cool properly.
- Use a vacuum or duster to keep heater and vent area clean from dust and dirt.
- The exterior of the fireplace should be cleaned with a damp cloth or duster.  
Do not use abrasive cleaners or liquid sprays.

### WARNINGS AND CAUTIONS

- WARNING** To avoid electrical shock not open the back panel of the insert unless the Power has been turned off. And the insert has been unplugged.
- WARNING** Any electrical repairs to this electric fireplace. Should only be Performed by a qualified technician.
- WARNING** Any electrical wiring repairs should only be performed by a qualified Technician. And also must comply with local buildings codes.
- WARNING** Discontinue use of this electric fireplace if any of the follow has Occurred: Water damage. If insert has been or dented. If power cord has Become broken. If power cord becomes hot to touch, if unit smokes or Smells like smoke.

**Note:** When the heat functions is used for the first time. A slight odor may be Present. This is normal and should be occur again unless heater is not used For extended periods of time and dust is allowed to accumulate on heater Element.

### Technical Specification

- **Supply: 220-240V 50-60Hz**
- **Rated power:900W/1800W**

### Safety Cut-Off

- This appliance is fitted with a safety cut-off which will operate if the fire overheats (e.g. due to blocked air vents) .For safety reasons, the fire will NOT automatically reset.
- To reset the appliance, disconnect the appliance from the mains supply for at least 15 minutes. Reconnect the supply to the mains and switch on the appliance.

## Troubleshooting

Symptom	Solution
No operation/no fan,	Check fuse by replacement, Check for safety cut-off operation,
No fire effect light,	Check the LED light with technician.



Meaning of crossed – out wheeled dustbin:

Do not dispose of electrical appliances as unsorted municipal waste, use separate collection facilities. Contact you local government for information regarding the collection systems available.

If electrical appliances are disposed of in landfills or dumps, hazardous substances can leak into the groundwater and get into the food chain, damaging your health and well-being.

**When replacing old appliances with new ones, the retailer is legally obligated to take back your old appliance for disposals at least free of charge.**