

PRODUCT ASSEMBLY INSTRUCTIONS

[Product Model: MG029-1200]

List :

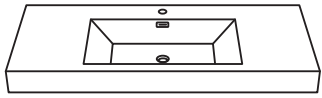

Solid Surface Bathroom Sink x1

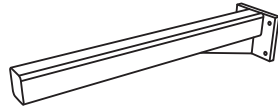

Support x2



Expansion Bolt x8

Tools Required :

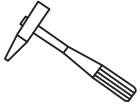

Hammer

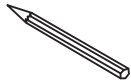

Pencil

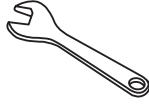

Wrench



Electrodrill

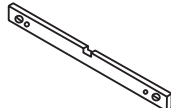

Gradienter

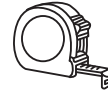

Steel tape

Installation steps : 1

Measure the distance of the mounting holes, and the height you want, mark with the pencil.
(33"-36" is preferred for countertop height).

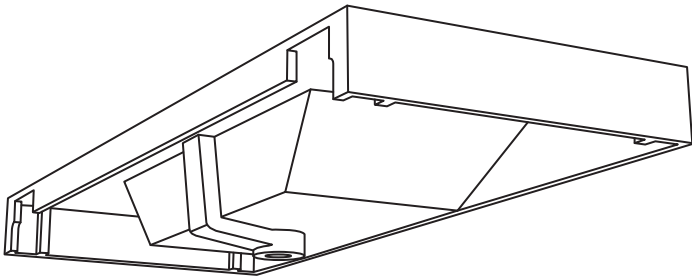

[The back of the product]

Installation steps : 2

Drill the hole at the mark with electric drill.

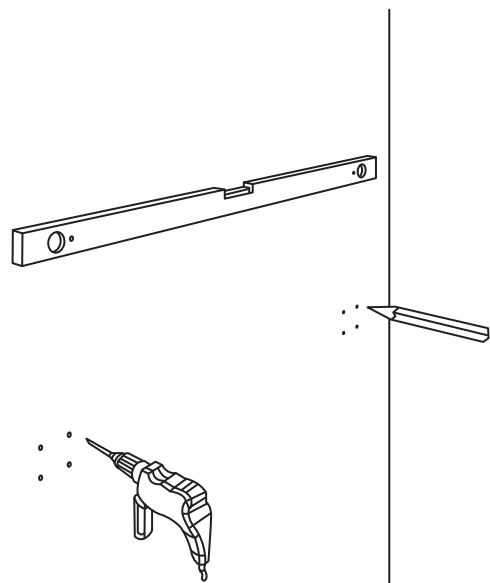

Installation steps : 3

Insert the wall plug and mount screws into the wall. Install the brackets. Put some glue on the surface of brackets.

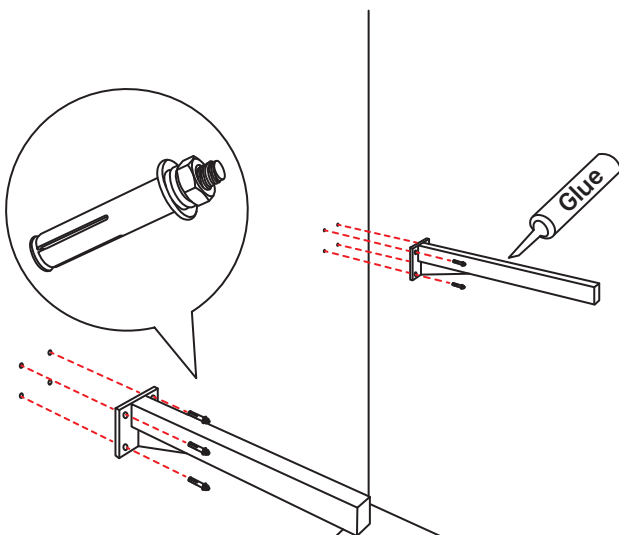

Installation steps : 4

Install the product onto the stand.

⚠ Before installing your bathroom sink, make sure the brackets are secure.

