

PENDANT LAMP ASSEMBLING INSTRUCTION

Please read the instructions care fully before start insatllation



Suggested tools for assembling



Wrench



Screw driver



Drill



Measurement tape

Before start assembling

- Safety first
- Turn off power
- Use proper tools
- Check for damage
- Follow the instructions
- Keep the product dry
- Don't work alone
- Seek professional help

WARNING !!!

Before proceeding make sure the electricity is switch off at the main supply

Basic installation Instructions



Make sure to turn off the power source to the circuit you will be working on. Locate the circuit breaker or fusebox and turn off the switch or remove the fuse that controls the circuit.

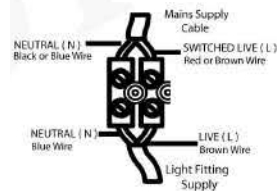

Use wire connectors for safty connection. Wire connectors are a common and important electromechanical component. Connectors can join to

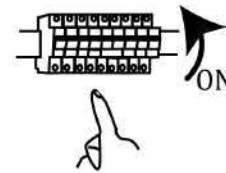

Continue to next page for the product Assembling

WARNING !!!

Before proceeding make sure the electricity is switch off at the main supply

ACCESSORIES FIGURE



x1Pcs

A



x3Pcs

G



x2Pcs

B



x3Pcs

H



x2Pcs

C



x1Pcs

I



x2Pcs

D



x3Pcs

E



x3Pcs

F

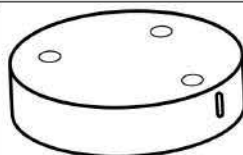

x1Pcs

J

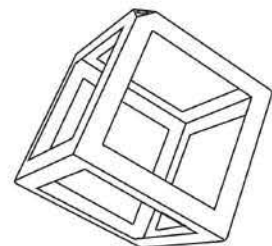

x3Pcs

K

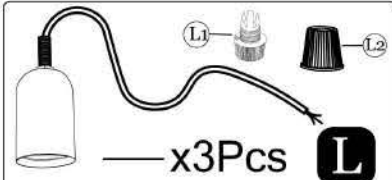

x3Pcs

L

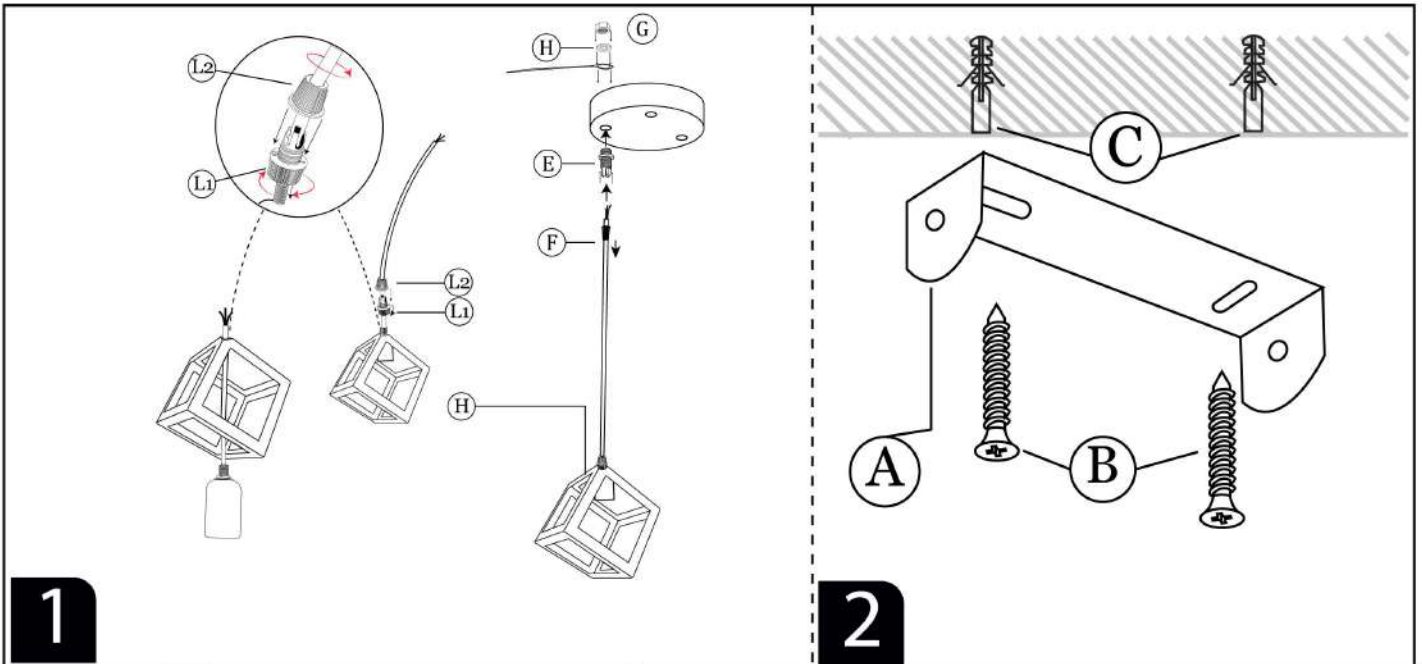

1

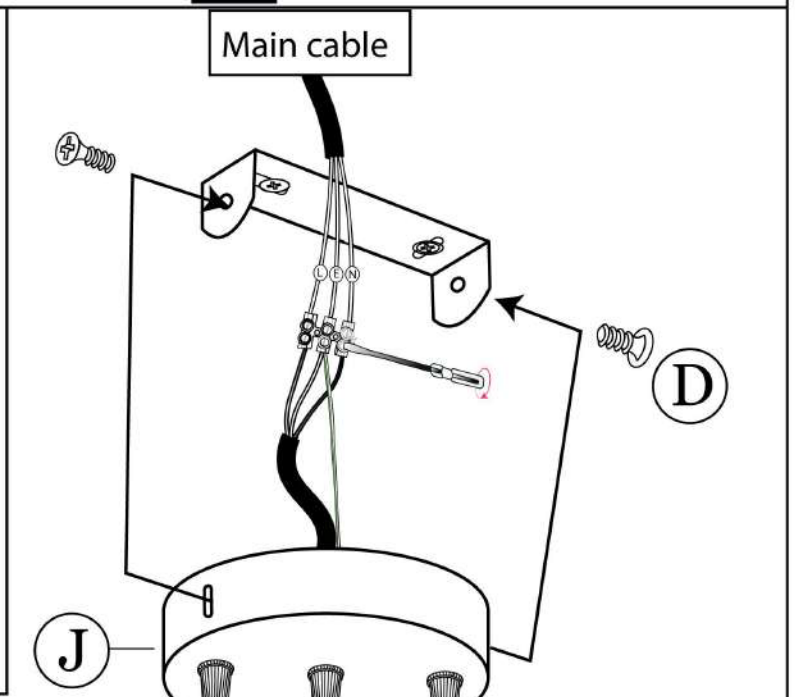
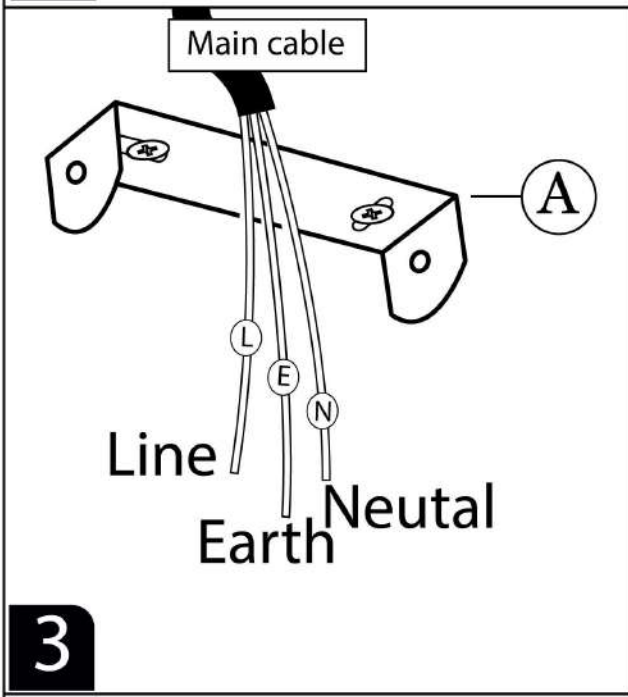

2

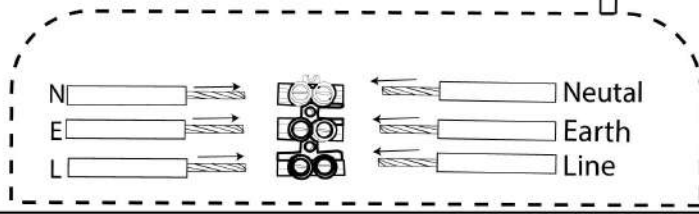

3

4



European Cord Colour	
	Blue- Neutral
	Green- Earth
	Brown- Line