

# **THE ALISIO CEILING FAN INSTALLATION INSTRUCTIONS**

Please read and save these instructions

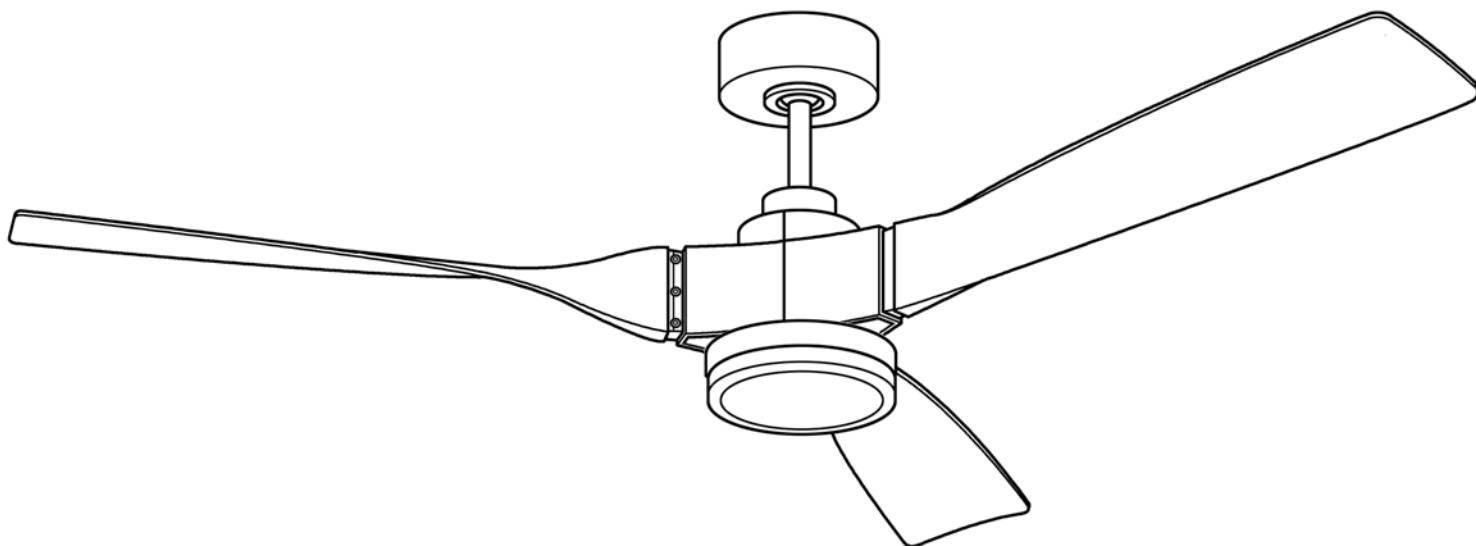

---

**These instructions are to be used in  
the installation of the following  
QUORUM INTERNATIONAL fans...**

The Alisio  
Ceiling Fan

*Cyan*  
design

© 2017 cyan Lighting. All Rights reserved.

# CYAN'S UNIQUE LIMITED LIFETIME WARRANTY

This warranty gives you specific legal rights, and you may also have other rights which vary from state to state.

## WHAT IS COVERED-

Except as specified below, the manufacturer of this product warrants it to be free of all defects in workmanship and material.

## WHAT IS NOT COVERED BY THIS WARRANTY-

1. All costs of removal or reinstallation of the fan.
2. Damage resulting from failure to follow instructions contained herein.
3. Damage occurring during shipment of the product (claims must be presented to the carrier).
4. Damage resulting from accident, misuse, abuse, or neglect.
5. Damage resulting from the application of any exterior coating, or by the addition of any unapproved accessories.
6. Damage resulting from repair or attempted repair by anyone other than the manufacturer.
7. Damage resulting from causes other than product defects, including lack of

technical skill, competence, or experience of the user.

8. Glass or acrylic components or accessories.

9. Minor occurrences of wobble are accepted as normal and should not necessarily be considered a defect.

## WHO MAY ENFORCE WARRANTY-

This warranty may be enforced only by the original purchaser. The end user must possess a dated proof of purchase from an authorized Cyan dealer to establish a warranty claim.

## LENGTH OF THE WARRANTY -

1. For the fan motor - for the lifetime of the original purchaser.
2. For everything else, except blades and finish - one year from the date of purchase.
3. For fan blades and finish - 90 days from the date of purchase.

## WHAT WE WILL PAY FOR -

We agree to correct defects outlined in the warranty without charge, or at our option replace the fan with an equivalent or

superior product if the defective unit is returned prepaid to us.

## TO GET WARRANTY SERVICE -

To obtain warranty service, the product must be returned prepaid to Cyan. (This warranty is not enforceable outside the United States.) Details regarding return shipment are explained elsewhere in this manual. Whenever warranty service is required, **you must present a copy of the original dated sales receipt as proof of coverage.**

*There is no other express warranty. Cyan hereby disclaims any and all implied warranties, including but not limited to those of merchantability of fitness for a particular purpose to the extent permitted by law. Cyan shall not be liable for incidental, consequential, or special damages arising out of or in connection with the product use or performance except as may otherwise be accorded by law. The duration of any implied warranty which cannot be disclaimed is limited to the periods specified above in the express warranty.*

# WARRANTY SERVICE

1. Most problems can be handled by our customer service agents over the telephone. Customers seeking warranty repair or replacement for any fan or component are encouraged to call us for assistance. All returns must be issued a Return Goods Authorization number (RGA) prior to returning the defective unit or part. Call (877) 607-0202 - Monday thru Friday 8:00 a.m. - 5:00 p.m. CST to obtain a RGA number.
2. Arriving shipments will be refused if they do not bear a valid RGA number on the outside packaging.

3. A dated proof of purchase must accompany any fan or component clearly indicating the name of the original purchaser.
4. To avoid damage in transit, the product should be returned in its original box and packaging. Cyan will not bear responsibility for any shipping damage.
5. Any return of a fan or component must be shipped freight and insurance prepaid.

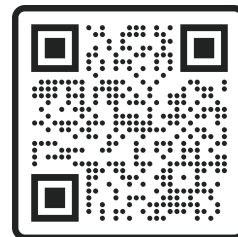

Scan the Warranty Registration QR Code to ensure your warranty is registered.

If you have any questions regarding the warranty, or the procedures for obtaining service, please call us at (877) 607-0202 - Monday thru Friday 8:00 a.m. - 5:00 p.m. CST.

# 1. SAFETY RULES

Model 11981: 14lbs

1. To avoid possible electric shock, **turn off the electricity** at the main fuse box or circuit panel before you begin the fan installation or before servicing the fan or installing accessories.
2. Read all instructions and safety information carefully before installing your fan and **save these instructions**.
3. Make sure all electrical connections comply with local codes or ordinances as well as the National Electrical Code. If you are unfamiliar with electric wiring, please use a qualified and licensed electrician.
4. Make sure you have a location selected for your fan which allows clear space for the blades to rotate, and at least seven (7) feet of clearance between the floor and the fan blade tips.
5. The outlet box and ceiling support joist used must be securely mounted, and **capable of supporting at least 50 pounds**. To reduce the risk of fire, electric shock, or personal injury, use only an outlet box clearly labeled "**Acceptable For Fan Support**".
6. To reduce the risk of personal injury use only approved hanging brackets and screws supplied with the outlet box for mounting to the outlet box.
7. After installation is complete, check that all connections are absolutely secure.
8. Do not insert anything into the fan blades while they are rotating.
9. To operate the reverse function on the fan, press the reverse button on the remote control while the fan is running.

10. Do not attempt to control the operation of the fan (or an optional light kit) from any remote control that is not approved by Cyan for use with its fans. Do not use solid state remote controls. The use of any unapproved control voids the fan's warranty.

11. Federal regulations require all ceiling fans with light kits manufactured or imported after January 1, 2009, to limit total wattage consumed by the light kit to 190W. Therefore, this fan is equipped with a wattage limiting device.

## TOOLS REQUIRED FOR INSTALLATION

Phillips Screwdriver  
Wire Cutters  
Electrical Tape  
Step Ladder

# 2. UNPACKING YOUR FAN

Unpack your fan and check the contents. Do not discard the carton. If warranty replacement or repair is ever necessary the fan should be returned in original packaging. Remove all parts and hardware. Do not lay motor housing on its side - because the decorative casing may shift. Check all visible screws, bolts and nuts for tightness. Examine all parts. The following parts should be included:

## NOTE:

Some Cyan fan models will have slightly different parts than what is shown here depending upon the design you have chosen. Basic installation procedures are similar for all models.

1. Fan motor assembly (a)
2. Set of 3 blades (b)
3. Canopy (c)
4. Yoke cover (d)
5. Blade medallion (e)
6. Hanger bracket (f)
7. Canopy cover (g)
8. Downrod (6") (h)
9. Light kit plate (i)
10. LED module (j)
11. Glass light shade (k)
12. Optional: Bottom cover (l)
13. Remote box (m) containing  
Remote control  
Receiver  
Wire nuts and screws  
DC3V battery
14. Parts bag (n) containing:  
Blade attachment hardware  
(Hex wrench, screw/lock washers, washers may be attached to screws)  
Mounting hardware (wood screws, machine screws, lock washers, spring washers, metal washers.)

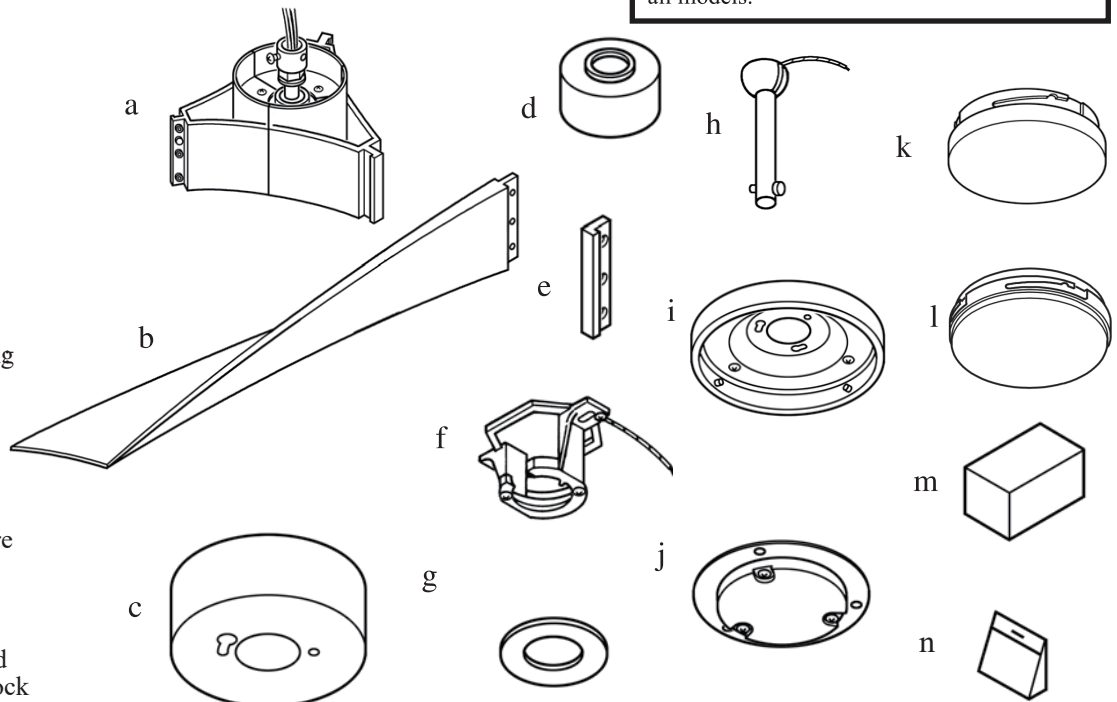

IF YOU FIND THAT PARTS ARE MISSING, CONTACT YOUR DEALER FOR REPLACEMENT, OR CALL CYAN DIRECTLY AND WE WILL MAIL REPLACEMENTS TO YOU IMMEDIATELY.

# 3. MOUNTING OPTIONS

1. Disconnect the power by removing fuses or turning off circuit breakers.

2. If there is an existing outlet box, ensure it is clearly marked "Suitable for Fan Support". If it is not so marked, it must be replaced with an approved one.

3. Secure the outlet box (or make sure the existing box is secured) directly to the building structure. Use appropriate fasteners and building materials.

4. Figures 1,2 and 3 are examples of different ways to mount the outlet box in different situations. A longer downrod may be required in sloped ceiling situations to maintain proper blade clearance.

5. To hang the fan in locations where no ceiling joist is available, a hanger support bar may be required (Figure 4). Hanger support bars are available at most area home centers.

**WARNING:** TO REDUCE THE RISK OF ELECTRIC SHOCK, FIRE, OR PERSONAL INJURY, MOUNT THE FAN ONLY TO AN OUTLET MARKED ACCEPTABLE FOR FAN SUPPORT AND USE MOUNTING SCREWS PROVIDED WITH THE OUTLET BOX.

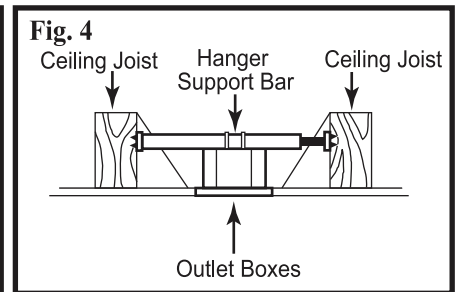
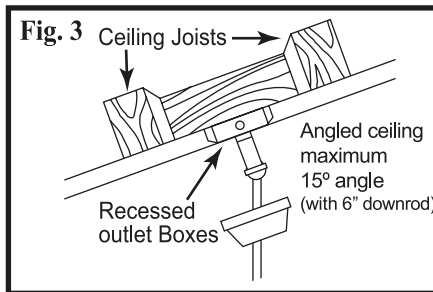
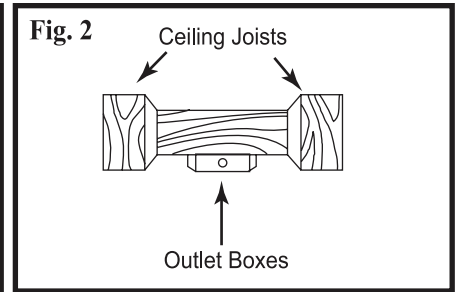
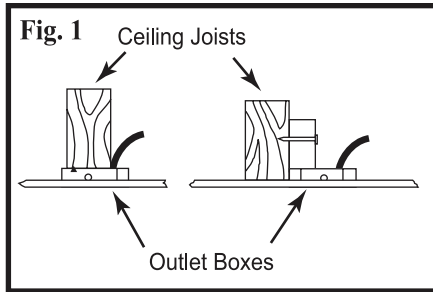

**CAUTION:** TO REDUCE THE RISK OF PERSONAL INJURY, INSTALL THE PRIMARY MOUNTING MEANS AND USE ONLY THE HARDWARE PROVIDED WITH THE FAN.

# 4. HANGING YOUR FAN

**WARNING -** Turn off the power!

1. Remove the set pin and safety lock clip from the yoke on top of the motor assembly (parts illustrated on downrod in Fig.5). Slide the downrod through the canopy and canopy cover. Slide the yoke cover onto the downrod (Fig. 6). Feed the wires from the fan motor through the downrod assembly.

2. (Fig. 7) Attach the downrod assembly (downrod, yoke cover, canopy cover and canopy) to the motor by sliding the downrod into the yoke on top of the motor assembly. Slide the set pin through the hole in the yoke and downrod and secure with the safety lock clip. Tighten the screws on the yoke. The yoke cover will lower down to conceal the yoke. Feed the wires through the downrod ball.

3. Attached the blade and blade medallion onto the blade bracket with the position pole on the bracket and blade medallion, Align the holes of blade medallion with blade and bracket. Then, using the provided hex wrench and hex screw to secure the blade and blade medallion.(Fig.8)

4. Secure the hanger bracket to the outlet box using the 2 provided long screws and washers (Fig. 9).

5. Lift the fan motor assembly and place into the hanger bracket, rotating the ball until the groove engages the tab on the hanger bracket. This locks the ball mount and fan motor, preventing fan rotation during operation (Fig. 10).

Fig. 5

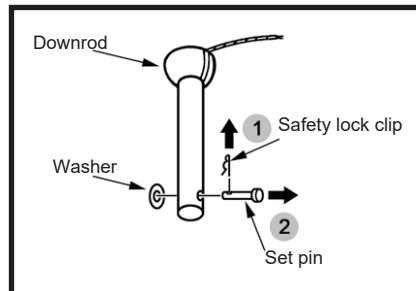

Fig. 6

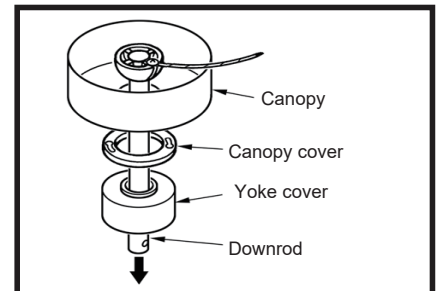

Fig. 7

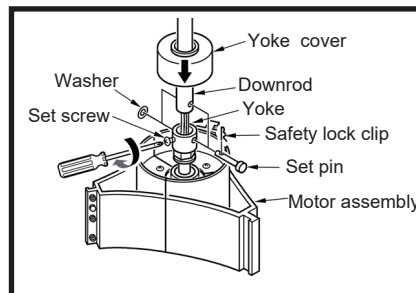

Fig. 8

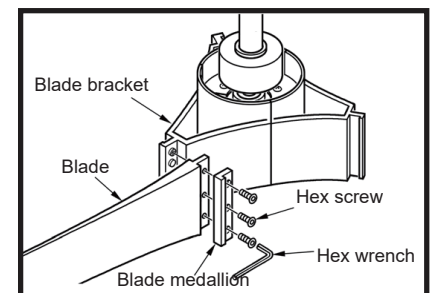

Fig. 9

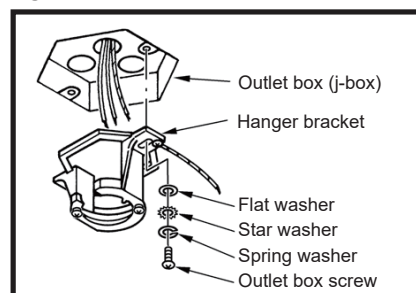
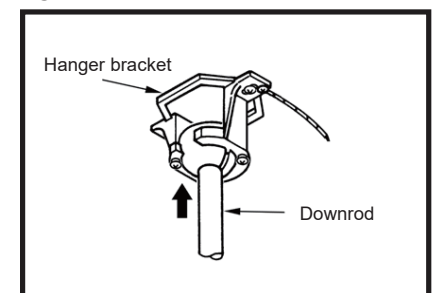

Fig. 10



# 5. ELECTRICAL CONNECTIONS

**WARNING! SHUT OFF THE POWER WITH FUSE OR CIRCUIT BREAKER.**

## 1. SAFETY PRECAUTIONS

- Disconnect electric power source by removing fuse or switching OFF circuit breaker.
- Do not use with solid state fans.
- Electrical wiring must meet all local and national electrical code requirements.
- Electrical source and fan must be 115/120 vold, 60Hz.
- Maximum fan motor 40W.

## 2. Use the wire nuts provided and make electrical connections (Fig. 11a & 11b) :

Motor to Receiver electrical connections:

- Connect the Grey wire from the fan to the Grey wire from the receiver.
- Connect the Red wire from the fan to the Red wire from the receiver.
- Connect the Purple wire from the fan to the Purple wire from the receiver.
- Connect the Blue wire from the fan to the Blue wire from the receiver.
- Connect the White wire from the fan to the White wire from the receiver.

Receiver to House Supply Electrical connections:

- Connect Green wire from fan to the bare copper (ground) from the junction box
- Connect Black receiver wire (AC IN L) to the Black wire from the junction box
- Connect White receiver wire (AC IN N) to the White wire from the junction box
- Lay the Black antenna wire on top of the receiver and insert into the mounting bracket

Fig. 11a

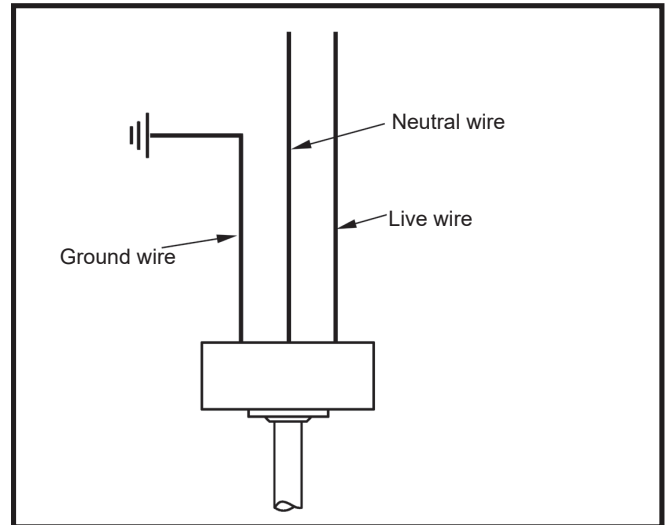
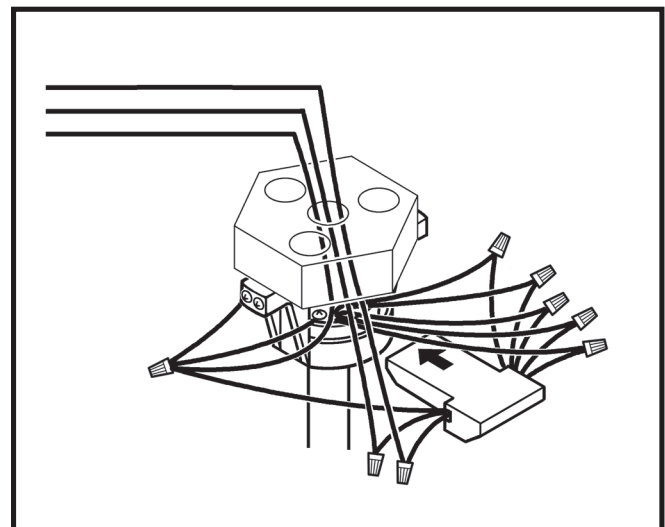

Fig. 11b



# 6. COMPLETING THE INSTALLATION

1. Make sure the wiring is safely inside the outlet box as instructed in **Step 5 -Electrical Connections**. To install the canopy, remove one of the two screws from the bottom of the mounting bracket and slightly loosen the other screw (Fig. 12). Slide the canopy up to mounting bracket and place the key hole on the canopy over the screw on the mounting bracket, turn canopy until it locks in place at the narrow section of the key holes. Secure by tightening the two set screws (Fig. 13).

2. Attach canopy cover by sliding up to canopy. Align key slot holes on ring to screws and turn to lock in place (Fig. 14). NOTE: you may need to adjust the canopy screws to allow the canopy cover to catch the screws.

3. Remove one of three screws from the flange, (do not discard) and loosen the other two screws. (Fig. 15)

4. Lift the light kit plate onto the flange and align the two key holes over the two loosened screws on flange. Turn the light kit plate clockwise until the screws are positioned at the narrowest section of the keyhole and align the other round hole with the hole on the flange.(Fig.16)

5. Tighten the previously loosened and removed screws. (Fig. 17)

6. If NOT installing LED kit, skip to step 11. If installing LED kit, proceed to steps 7-10.

7. Remove the three screws from the light kit plate (do not discard). (Fig. 18)

8. Connect the light wire from the fan to the LED module, and ensure it is properly plugged in. (Fig. 19)

9. Install the LED module onto the light kit plate and tighten the previously removed screws. (Fig. 20)

10. Attach glass light shade. Align the teeth inside the light kit plate with slots on the light shade and turn clockwise to secure it. (Fig. 21)

11. Optional: Attach bottom cover. If light is not required, attach the bottom cover by aligning the teeth inside the light kit plate with slots on the bottom cover and turning clockwise to secure it. (Fig.22)

Fig. 12

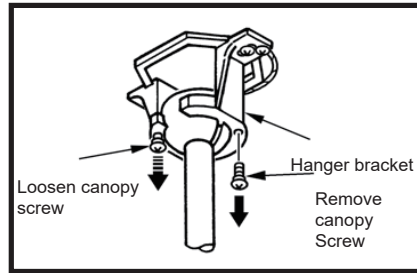

Fig. 13

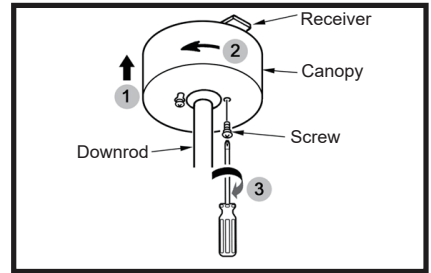

Fig. 14

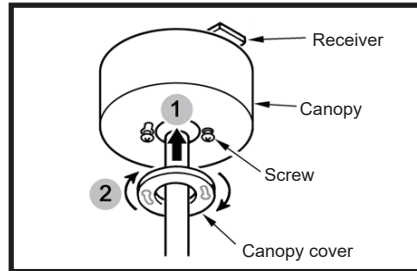

Fig. 15

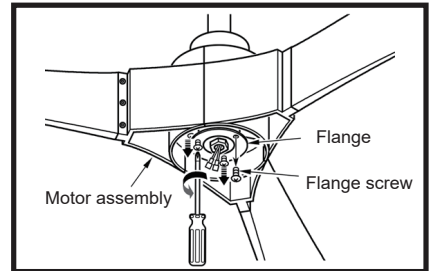

Fig. 16

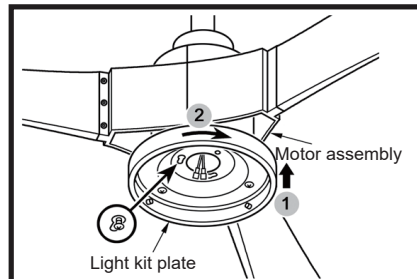

Fig. 17

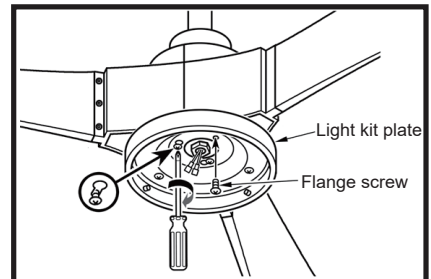

Fig. 18

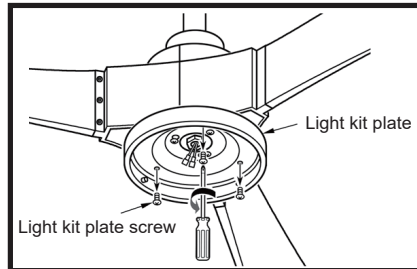

Fig. 19

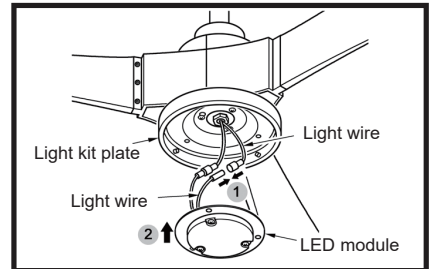

Fig. 20

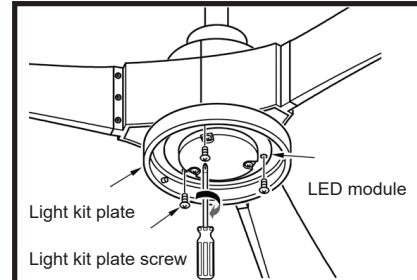

Fig. 21

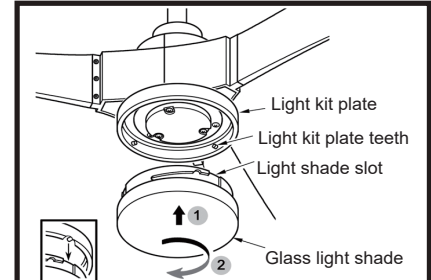
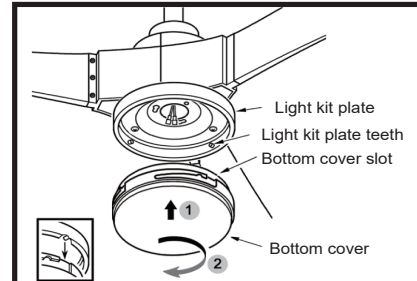

Fig. 22



# 7. REMOTE CONTROL

## INSTALLING THE TRANSMITTER (Fig. 23)

- Pull the wall plate apart from the control cover.
- Attach wall plate to the outlet box using the two screws provided.
- Attach the control cover to the wall plate.

## LEARNING PROCESS

**NOTE:** The Hand Held Remote Control System is equipped with a learning frequency function which has code combinations to prevent potential interference from other remote units.

Step: 1 Open the remote battery cover and install DC3V battery. (Fig.24)

Fig. 23

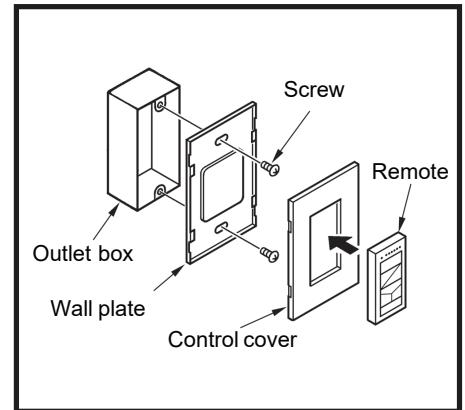

| <b>⚠ WARNING</b>   |  |
|--|--|
| <ul style="list-style-type: none"> <li>• <b>INGESTION HAZARD:</b> This product contains a button cell or coin battery.</li> <li>• <b>DEATH</b> or serious injury can occur if ingested.</li> <li>• A swallowed button cell or coin battery can cause <b>Internal Chemical Burns</b> in as little as <b>2 hours</b>.</li> <li>• <b>KEEP</b> new and used batteries <b>OUT OF REACH</b> of <b>CHILDREN</b>.</li> <li>• <b>Seek immediate medical attention</b> if a battery is suspected to be swallowed or inserted inside any part of the body.</li> </ul> |  |

Step: 2 Within 30 seconds of turning the Receivers DC power ON. Use a small tool to press the transmitter"learning button" about 3 seconds, once the receiver has detected the frequency,the receiver will beep two times, and the light will flicker twice. This will indicate the receiver has learned the frequency that was previously selected on the transmitter.

Note: After the DC power is on, do not press any other button on the transmitter before setting learning. Doing so will cause the procedure to fail.

After completing the steps above, you should be able to operate the ceiling fan and light. If the fan is not responding to the transmitter, please turn the power off to the receiver. And repeat step 1 and 2. Remove the battery if not used for long periods of time to prevent damage to the hand held remote.

Fig. 24

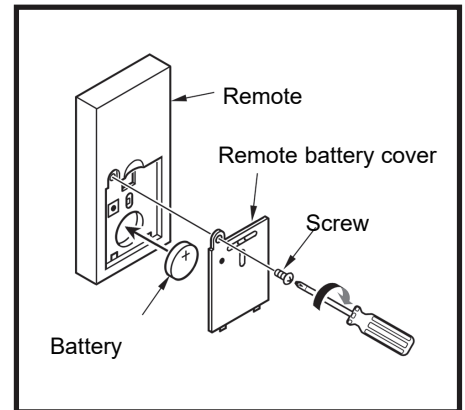

## FUNCTIONS OF TRANSMITTER

1. : To turn the fan off.
2. : Press this button to increasing fan speed and LED indicator would be on the position of fan speed. (1~6 speed)
3. : Press this button to decreasing fan speed and LED indicator would be on the position of fan speed.(1~6 speed)
4. : To set fan wind direction up or down.
5. : "Timer",press this button to set the time(1/3/6 hrs) of the fan.The LED indicator will be on the position of the time you set.  
Example: If press "Timer"button one time, it will be 1 hr, the LED on position "2".The second press, it will be 3 hr, the LED on position "4".The third press, it will be 6 hr, the LED on position "7".And so on .....
6. : "Natural wind", press the button for set fan speed change automatically to make the natural wind.
7. :To turn the light on or off.
8. When pressing remote button, the LED indicator would light up. If you press remote button and LED indicator does not light up, you should replace DC3V battery.
9. When pressing remote button, the receiver will sound to indicate signal from remote.

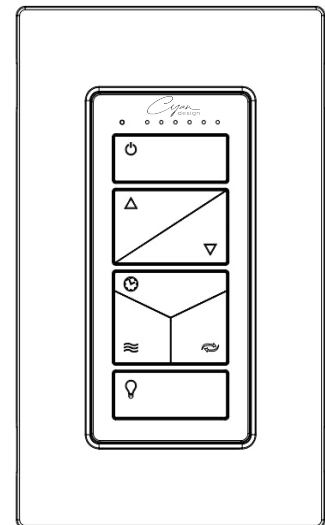

# 8. FAN OPERATION AND CARE

1. A ceiling fan is an environmentally smart choice to cool as well as to help warm your home or office. Adjust your HVAC thermostat during fan use to save additional energy and money on your air conditioning and heating utility bills. You should see a significant reduction in both your heating and cooling costs by regular use of your fan.

Do not hesitate to use your fan during summer and winter months. In summer, (Fig. 25) using the reverse switch, adjust the fan's direction so cool air is blown down, producing a cooling breeze. In winter, (Fig. 26) reverse the fan so that an upward airflow will push warm air off the ceiling and circulate it downwards into the living area. In winter months, use the fan at a lower speed than summer.

2. Periodically check tightness of all screws securing the blades to the blade arm attachment points. A clicking or a rattling noise is a sure indication of loosening screws. Since screws will invariably work loose over time, at least once a year, tighten all the screws attaching blades to blade arms. Do not bend blade arms when cleaning or servicing the fan.

3. Clean you fan periodically using only a cloth dampened with a mild detergent solution for all hardware - never use solvents. The finish plating is lacquered to prevent tarnishing. Use a lint-free cloth with clean water to clean blades.

4. You will never need to oil or lubricate your fan. Its permanently sealed bearings will provide trouble free, silent operation for many years.

5. If repairs or servicing are ever required, to avoid possible electric shock, turn off the electricity at the main fuse or circuit panel before you begin.

Fig.25

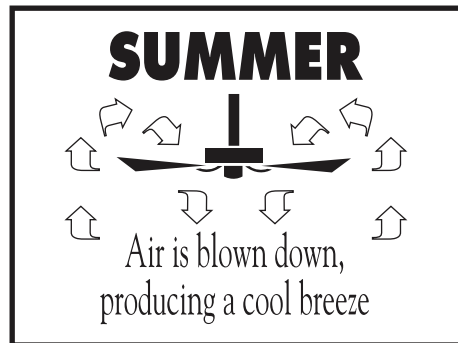
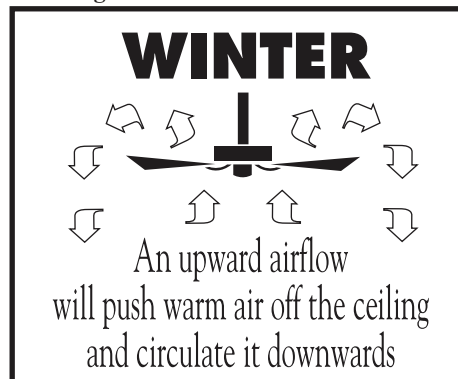

Fig.26



# 9. TROUBLESHOOTING

## FAN WILL NOT START

1. Check that the electricity has been turned on at the circuit breaker which had probably been turned off during installation.

2. Turn off the electricity. Check all connections in the wiring of the fan at the ceiling and make sure it follows the wiring instructions outlined in this manual.

## NOISE

**Note:** Always allow a day or two "run-in" time for any new fan at medium or high speed. When attempting to diagnose noise, listen carefully from several sides to try and isolate the location of the noise (blade, upper end, motor, light kit, etc.)

1. Tighten all screws attaching blades to blade arms. Remember to tighten these screws at least once a year because they may loosen slowly over time and cause a clicking noise.

2. Turn off the power. Loosen the canopy and check that the wiring and/or wire nut connectors are not resting against the canopy, possibly vibrating while the fan is on.

3. Use of a standard light rheostat or an unapproved fan remote control to control the fan speed will always cause an annoying "hum". Many fan motors do not work quietly with solid state variable speed controls.

4. Check that the rubber gasket on the mounting bracket has been installed if called for in the installation instructions.

5. Check that the canopy is not touching the ceiling.

6. Check that all screws on the motor housing and the bottom housing are tight.

## FAN TURNS, BUT DOES NOT MOVE MUCH AIR

1. The fan may be running in reverse. Press the reverse button on transmitter to set the fan in forward operation.

2. The distance from the ceiling to the blades may be too small. For downrod fans, optimal placement would be 8-9 feet from the floor.

3. The room may contain items which obstruct the air flow.

4. The fan may be too small for the size of the room.

## EXCESSIVE WOBBLE

**Note:** A small amount of wobble is considered acceptable and should not be considered a defect.

1. Make certain all blades are tightly attached to each blades' respective blade arm.

## REPLACEMENT PARTS AVAILABLE

A full range of genuine replacement spare parts are available at reasonable cost directly from Cyan Lighting. Please call us at (877) 607-0202, Monday through Friday from 8:00 A.M. to 5:00 P.M. CST.