

USER MANUAL

CAUTION

1. BE SURE THE ELECTRICITY TO THE WIRES YOU ARE WORKING ON IS SHUT OFF; EITHER THE FUSE IS REMOVED OR THE CIRCUIT BREAKER IS TURNED OFF. TURNING THE POWER OFF USING THE LIGHT SWITCH IS NOT SUFFICIENT TO PREVENT ELECTRICAL SHOCK.
2. DO NOT INSTALL OR USE THE LIGHT FIXTURE IF ANY PART IS MISSING OR DAMAGED. CONTACT YOUR DEALER FOR REPLACEMENT OR MISSING PARTS.
3. TO PROTECT THE FINISH, WEAR GLOVES BEFORE INSTALLATION, DO NOT USE CLEANSERS OR ABRASIVES DURING MAINTENANCE.
4. TO AVOID POSSIBLE FIRE OR ELECTRICAL SHOCK, MAKE SURE NO BARE WIRE STRANDS ARE EXPOSED OUTSIDE WIRE CONNECTORS.



INSTALLATION DIAGRAM

CAUTION

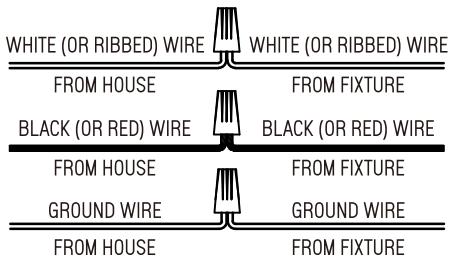

wrench

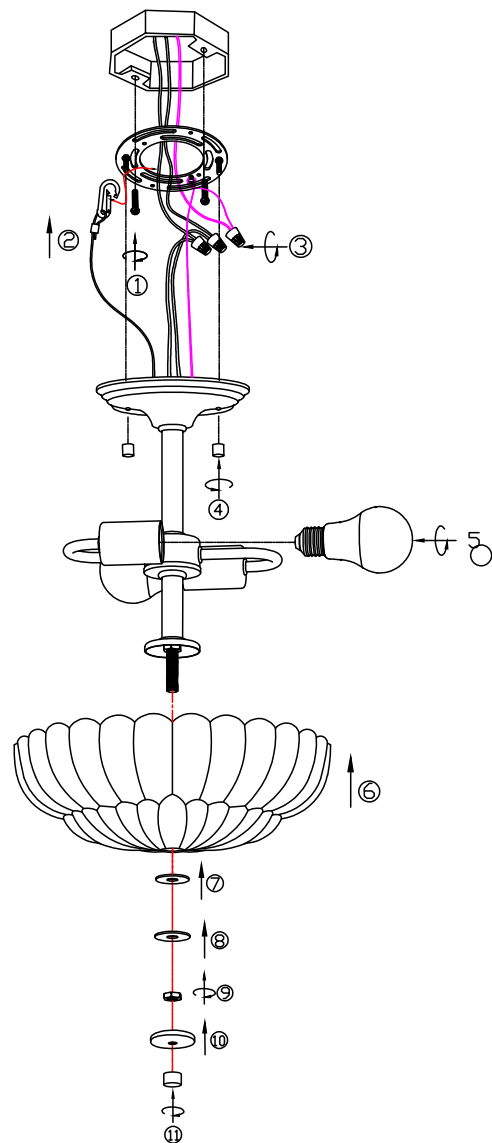
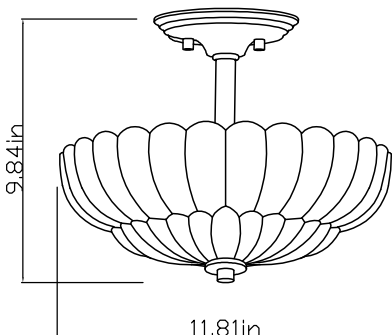
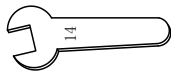

SPECIFICATIONS

Input Voltage: 110 ~ 120V 50/60Hz

Wattage: E26 Max 60W per socket, bulb not included

Fixture Size: length in 11.81in(40cm) x width in 11.81in(40cm) x height in 9.84in(25cm), after bulb mounted